

**FM 101-5-1
MCRP 5-12A
(Formerly MCRP 5-2A)**

Operational Terms and Graphics



U.S. Marine Corps

PCN 144 000008 00

Field Manual
No. 101-5-1
Marine Corps Reference Publication
No. MCRP 5-2A

Headquarters
Department of the Army
United States Marine Corps
Washington, DC, 30 September 1997

Operational Terms and Graphics

Contents

	Page
Preface	iii
Chapter 1 Operational Terms	1-1
Chapter 2 Operational Acronyms and Abbreviations	2-1
Chapter 3 Graphic Control Measures	3-1
Graphic Overlays	3-1
Use of Graphics	3-1
Maneuver	3-5
Maneuver and Fire	3-21
Fire Support	3-22
Command and Control	3-25
Mobility and Survivability	3-27
Survivability	3-33
Combat Service Support	3-37
Chapter 4 Unit Symbols	4-1
Icon-Based Symbols	4-1
Building Unit Symbols	4-3
Symbols For The Ground Environment	4-6
Unit Symbol Modifiers	4-8
Combat Arms	4-10
Combat Support	4-19
Combat Service Support	4-23
Special Operations Forces (SOF)	4-29

DISTRIBUTION RESTRICTION: Approved for public release; distribution unlimited.

*This publication supersedes FM 101-5-1, 21 October 1985.

MARINE CORPS PCN: 144 000008 00

OPERATIONAL TERMS AND GRAPHICS

	Page
Chapter 5	
Equipment Symbols	5-1
Equipment Symbol Labeling	5-1
Building an Equipment Symbol	5-4
Composite Weapon System Symbols	5-5
Modifiers	5-6
Mobility Modifiers	5-7
Types of Ground Equipment	5-8
Vehicle Symbols	5-9
Aircraft/Aerial Vehicles	5-10
Appendix A	
Friendly Unit and Equipment Symbols	A-1
Appendix B	
Enemy Unit and Equipment Symbols	B-1
Appendix C	
Military Decisionmaking Process and Tactical Mission Graphics	C-1
Appendix D	
Stability and Support Operations Symbology	D-1
Appendix E	
Multiservice Tactical Brevity Codes	E-1
References	References-1

Preface

PURPOSE

This manual sets forth procedures for the United States Army and the United States Marine Corps in the use of land-based warfighting symbology. An extensive set of symbols for the Air Force and Navy is found in Military Standard 2525A. The manual is a dictionary of operational terms and military graphics. It is designed for commanders and staffs from company through corps to communicate instructions to subordinate units.

This manual describes symbols for use in the force domain (maneuver command and control) but does not supersede the military standards that describe symbols for use in the engagement domain ("radar" tracking, evaluation, engagement, or engagement system directing). Military standards established for air defense engagement and systems control and aircraft "heads up" displays are to be used. When information is transferred from an engagement domain system to a force domain command and control system, it will be automatically or manually converted to the force domain symbols in this publication.

SCOPE AND APPLICABILITY

This doctrine applies to all Army and Marine Corps commanders and staffs. For overseas theaters, the procedures govern US unilateral operations only. For combined operations, applicable multinational procedures apply. This manual does conform to the appropriate NATO requirements.

IMPLEMENTATION PLAN

Definitions and terms used in this manual agree with those expressed in Joint Publication (JP) 1-02, Army Regulation (AR) 310-25, and Fleet Marine Force Reference Publication (FM FRP) 0-14. This manual agrees with MILSTD 2525A, subject to its approval by all services. The provisions of this manual are the subject of international agreement(s):

1059 National Distinguishing Letters for Use by NATO Armed Forces

2019 Military Symbols for Land Based Systems

2022 Intelligence Reports

2961 Classes of Supply of NATO Land Forces

3680 NATO Glossary of Terms and Definitions (AAP-6)

4420 Display Symbology and Colors for NATO Maritime Units

USER INFORMATION

The proponent of this publication is HQ TRADOC. Send comments and recommendations on Department of the Army (DA) Form 2028 (Recommended Changes to Publications and Blank Forms) directly to:

Commander
US Army Combined Arms Center
ATTN: ATZL-SWW-D (Bldg. 111)
Ft Leavenworth, KS 66027-6900

or

Commanding General
Doctrine Division (C42)
MCCDC
3300 Russell Rd.
Quantico, VA 22134-5021

Unless this publication states otherwise, masculine nouns and pronouns do not refer exclusively to men.

Chapter 1

Operational Terms

The shadowed boxes **2-16** show the page number for the symbol or graphic for those definitions with graphic representations

A

abatis — A vehicular obstacle constructed by felling trees (leaving a 1- to 2-meter stump above the ground on both sides of a road, trail, gap, or defile) so that they fall, interlocked, toward the expected direction of enemy approach. The trees should remain attached to the stumps and be at a 45-degree angle to the roadway. The obstacle itself should be at least 75 meters in depth to be most effective. See FM 5-102.

3-27

abort criteria — A predetermined set of circumstances, based on risk analysis, which makes the success of an operation no longer probable; thus the operation is terminated. These circumstances can relate to changes in safety, equipment or troops available, preparation or rehearsal time, weather, enemy, losses during execution, or a combination of the above. (See also air assault and deep operations.) See FMs 71-100-2, 90-4, and JP 3-18.1.

above ground level (AGL) — The altitude of an aircraft as measured between the terrain (excluding vegetation and man-made structures) and the aircraft. The altitude is usually not the same as measured from sea level. (See also coordinating altitude.) See FMs 1-111, 17-95, 90-4, and 100-103.

absorbed dose (JP 1-02, NATO) — The amount of energy imparted by nuclear (or ionizing) radiation to unit mass of absorbing material. The unit is the rad. (Army) — **1.** This term is being replaced by the term centigray that is the equivalent of 100 rads. **2.** A unit of energy absorbed by a material, such as body tissue, from nuclear (ionizing) radiation, equal to 100 ergs per gram of material. See also centigray and dose rate. See FMs 3-3-1 and 3-4.

accompanying supplies (JP 1-02) — Unit supplies that deploy with forces. (Army) — All classes of supplies carried by units and individual soldiers during deployment to, and redeployment from, an area of operations or training exercise area. (See also basic load, classes of supply, and combat load.) See FMs 100-10 and 100-16.

acknowledge — A directive from the originator of a communication requiring the addressee(s) to advise the originator that his communication has been received and understood. This term is normally included in the electronic transmission of orders to ensure the receiving station or person confirms receipt of the order. (See also acknowledgment.)

acknowledgment (JP 1-02, NATO) — A message from the addressee informing the originator that his or her communication has been received and is understood. (See also acknowledge.)

acoustical surveillance (JP 1-02) — Employment of electronic devices, including sound-recording, -receiving, or -transmitting equipment, for the collection of information. See FM 34-10-1.

OPERATIONAL TERMS AND GRAPHICS

active air defense (JP 1-02, NATO) — Direct defensive action taken to nullify or reduce the effectiveness of hostile air action. It includes such measures as the use of aircraft, air defense weapons, weapons not used primarily in an air defense role, and electronic warfare. (Army) — Direct defensive action taken to destroy attacking enemy aircraft or missiles. See FMs 44-63 and 44-100.

active component (Army) — That portion of each of the armed forces (such as the Regular Army) that serves 24 hours a day, 365 days a year, until retired; transferred to a reserve unit, inactive reserve, or National Guard; or discharged from service. This does not include those in an active duty guard or a reserve status but does include reserve officers serving a contractual period of active duty after commissioning.

active defense (Army) — Applies to operations initiated to protect assets against a tactical missile attack by destroying theater missile (TM) airborne launch platforms or destroying TMs in flight. Active defense includes multitiered defense in depth via multiple engagements using air, land, and sea theater missile defense systems. It also includes using electronic warfare to disrupt enemy remote or onboard guidance systems. See FM 44-100 and JP 3-01.5.

active duty for training (JP 1-02) — A tour of active duty which is used for training members of the Reserve Components to provide trained units and qualified persons to fill the needs of the Armed Forces in time of war or national emergency and such other times as the national security requires. The member is under orders which provide for return to nonactive status when the period of active duty for training is completed. It includes annual training, special tours of active duty for training, school tours, and the initial duty for training performed by nonprior service enlistees.

add — In artillery, naval gunfire, mortar, and other types of gunnery, a correction used by an observer or a spotter to indicate that an increase in range along the observer target line is desired. See FMs 6-20, 17-12, and 23-1.

adjust (JP 1-02) — An order to the observer or spotter to initiate an adjustment on a designated target. See FM 6-20.

adjust fire (JP 1-02, NATO) — In artillery and naval gunfire support: **1.** An order or request to initiate an adjustment of fire. **2.** A method of control transmitted in the call for fire by the observer or spotter to indicate that he will control the adjustment. (Army) — Pertains to mortar fire also. See FM 6-20.

adjustment of fire (JP 1-02, NATO) — Process used in artillery and naval gunfire to obtain correct bearing, range, and height of burst (if time fuzes are used) when engaging a target by observed fire. (Army) — Pertains to mortar fire also. (See also call for fire.) See FM 6-20.

administrative control (JP 1-02) — Direction or exercise of authority over subordinate or other organizations in respect to administration and support, including organization of Service forces, control of resources and equipment, personnel management, unit logistics, individual and unit training, readiness, mobilization, demobilization, discipline, and other matters not included in the operational missions of the subordinate or other organizations. (See also command relationship.) See FMs 1-111, 71-100, 100-5, 100-7, 100-15, and JP 0-2.

administrative landing (JP 1-02) — An unopposed landing involving debarkation from vehicles which have been administratively loaded. (See also administrative movement.) See FM 71-100-2 and JP 3-02.

administrative movement (JP 1-02, NATO) — A movement in which troops and vehicles are arranged to expedite their movement and conserve time and energy when no enemy interference, except by air, is anticipated. (See also administrative landing.) See FM 101-5.

advance to contact (JP 1-02, NATO) — An offensive operation designed to gain or reestablish contact with the enemy. (See also administrative movement, approach march, and movement to contact.)

advanced operations base (AOB) (JP 1-02) — In special operations, a small temporary base established near or within a joint special operations area to command, control, and/or support training or tactical operations. Facilities are normally austere. The base may be ashore or afloat. If ashore, it may include an airfield or unimproved airstrip, a pier, or an anchorage. An advanced operations base is normally controlled and/or supported by a main operations base or a forward operations base. (See also forward operations base (FOB) and main operations base (MOB).) See FM 100-25.

advance guard (JP 1-02) — Detachment sent ahead of the main force to ensure its uninterrupted advance; to protect the main body against surprise; to facilitate the advance by removing obstacles, and repairing roads and bridges; and to cover the deployment of the main body if it is committed to action. (Army) — A task-organized combined arms unit or detachment that precedes a column or formation to protect the main body from ground observation or surprise by an enemy. It operates within the supporting range of the main body. (See also exploitation, movement to contact, pursuit, and reconnaissance in force.) See FMs 17-95, 71-100, 100-5, and 100-15.

advance party — A team that coordinates the convoy's arrival at the destination. It may move with the main body initially but must arrive at the destination sufficiently ahead of the main body. (See also march column and quartering party.) See FM 55-30.

aerial port (JP 1-02) — An airfield that has been designated for the sustained air movement of personnel and materiel, and to serve as an authorized port for entrance into or departure from the country in which located. See FMs 55-12 and 100-17. **4-29**

aerial port of debarkation (APOD) — An airfield for sustained air movement at which personnel and material are discharged from aircraft. APODs normally serve as ports of embarkation for return passengers and retrograde cargo shipments. See FM 55-12. **4-29**

aerial port of embarkation (APOE) — An airfield for sustained air movement at which personnel and material board or are loaded aboard aircraft to initiate an aerial movement. APOEs may serve as ports of debarkation for return passengers and retrograde cargo shipments. See FM 55-12. **4-29**

aeromedical evacuation (JP 1-02) — The movement of patients under medical supervision to and between medical treatment facilities by air transportation. (Army) — Movement of patients usually from a lower echelon medical treatment facility to a higher echelon medical treatment facility. See FM 8-10-6.

aerospace defense (JP 1-02) — **1.** All defensive measures designed to destroy or nullify attacking enemy aircraft and missiles and also negate hostile space systems. **2.** An inclusive term encompassing air defense, ballistic missile defense, and space defense. (See also air defense.) See FM 44-100.

afloat support (JP 1-02, NATO) — A form of logistic support outside the confines of a harbor in which fuel, ammunition, and supplies are provided for operating forces either underway or at anchor. See FM 71-100-2 and JP 3-02.

agility — The ability of friendly forces to act faster than the enemy and is a prerequisite to seizing and holding the initiative. Agility is a mental as well as a physical quality. See FM 100-5.

OPERATIONAL TERMS AND GRAPHICS

aid station — The first medical treatment "facility" that can provide advanced trauma management to a battlefield casualty. It provides first level of triage evaluation of casualties and conducts routine sick call. (See also medical care echelon.) See FMs 8-10-3, 8-10-4, 8-10-5, 8-10-24, and 8-55. **4-26**

air (JP 1-02, NATO) — In artillery and naval gunfire support, a spotting, or an observation, by a spotter or an observer to indicate that a burst or group of bursts occurred before impact. (Army) — Pertains to mortar fire also. (See also adjustment of fire.) See FM 6-20.

air assault (Army) — Operations in which air assault forces (combat, combat support, and combat service support), using the firepower, mobility, and total integration of helicopter assets in their ground or air roles, maneuver on the battlefield under the control of the ground or air maneuver commander to engage and destroy enemy forces or to seize and hold key terrain. (See also abort criteria, airhead, air mission brief (AMB), and air mission commander (AMC).) See FMs 71-100-3, 90-4, and JP 3-18.1. **4-8**

4-16 **A-4**

airborne (JP 1-02, NATO) — **1.** In relation to personnel, troops especially trained to effect, following transport by air, an assault debarkation, either by parachuting or touchdown. **2.** In relation to equipment, pieces of equipment that have been especially designed for use by airborne troops during or after an assault debarkation. It also designates some aeronautical equipment used to accomplish a particular mission. **3.** When applied to materiel, items that form an integral part of the aircraft. **4.** The state of an aircraft, from the instant it becomes entirely sustained by air until it ceases to be so sustained. A lighter-than-air aircraft is not considered to be airborne when it is attached to the ground, except that moored balloons are airborne whenever sent aloft. See FMs 7-30, 71-100, and JP 3-18.1. **4-8**

4-16 **A-4**

airborne battlefield command and control center (ABCCC) (JP 1-02) — A United States Air Force aircraft equipped with communications, data link, and display equipment; it may be employed as an airborne command post or as a communications and intelligence relay facility. See FMs 71-100-2 and 100-8.

airborne early warning and control (JP 1-02, NATO) — Air surveillance and control provided by airborne early warning aircraft which are equipped with search and height-finding radar and communications equipment for controlling weapon systems. See FMs 44-100 and 100-15.

airborne force (JP 1-02, NATO) — A force composed primarily of ground and air units organized, equipped, and trained for airborne operations. (Army) — A force with a great capability for large-scale force-projection operations by conducting combined arms assaults by parachute or air landing. See FMs 7-30, 71-100, 101-5, and JP 3-18.1.

airborne operation (JP 1-02) — An operation involving the air movement into an objective area of combat forces and their logistic support for execution of a tactical or a strategic mission. The means employed may be any combination of airborne units, air transportable units, and types of transport aircraft, depending on the mission and the overall situation. See FMs 7-30, 71-100, and JP 3-18.1.

airburst (JP 1-02, NATO) — An explosion of a bomb or projectile above the surface as distinguished from an explosion on contact with the surface or after penetration. (See also weapons of mass destruction.) See FMs 3-3-1 and 6-series.

air controller (JP 1-02, NATO) — An individual especially trained for and assigned the duty of the control (by use of radio, radar, or other means) of such aircraft as may be allotted to him for operation within his area. See FMs 1-111 and 100-103.

air control point (ACP) (Army) — An easily identifiable point on the terrain or an electronic navigational aid used to provide necessary control during air movement. ACPs are generally designated at each point where the flight route or air corridor makes a definite change in direction and at any other point deemed necessary for timing or control of the operation. (See also air corridor, communications checkpoint (CCP), and minimum-risk route (MRR).) See FMs 1-111, 71-100-3, and 100-103. **3-5**

air corridor (JP 1-02, NATO) — A restricted air route of travel specified for use by friendly aircraft and established to prevent friendly aircraft from being fired on by friendly forces. (Army) — Used to deconflict artillery firing positions with aviation traffic, including unmanned aerial vehicles. (See also air control point (ACP).) See FMs 1-111, 71-100-3, and 100-103. **3-5**

air defense (JP 1-02) — All defensive measures designed to destroy attacking enemy aircraft or missiles in the Earth's envelope of atmosphere, or to nullify or reduce the effectiveness of such attack. (See also active air defense, aerospace defense, air defense suppression, and passive air defense.) See FMs 44-63 and 44-100. **4-10, 4-11**

air defense suppression (JP 1-02) — In air operations, actions taken to degrade fixed and mobile surface-based components of enemy air defense systems so that offensive air forces may effectively attack a target. See FMs 1-111, 6-20 series, 44-63, and 44-100.

air defense warning (local) (LADW) (Army) —

Dynamite — Aircraft are inbound or attacking now. Response is immediate.

Lookout — Aircraft are in the area of interest but are not threatening or are inbound but there is time to react.

Snowman — No aircraft pose a threat at this time.
See FM 44-100.

air defense warning conditions (JP 1-02) — A degree of air raid probability according to the following code. The term air defense division/sector referred to herein may include forces and units afloat and/or deployed to forward areas, as applicable. **a. Air defense warning yellow** — attack by hostile aircraft and/or missiles is probable. This means that hostile aircraft and/or missiles are en route toward an air defense division/sector, or unknown aircraft and/or missiles suspected to be hostile are en route toward or are within an air defense division/sector. **b. Air defense warning red** — attack by hostile aircraft and/or missiles is imminent or is in progress. This means that hostile aircraft and/or missiles are within an air defense division/sector or are in the immediate vicinity of an air defense division/sector with high probability of entering the division/sector. **c. Air defense warning white** — attack by hostile aircraft and/or missiles is improbable. May be called either before or after air defense warning yellow or red. The initial declaration of air defense emergency will automatically establish a condition of air defense warning other than white for purposes of security control of air traffic. See FMs 44-63 and 44-100.

air defense weapon control status — The degree of fire control imposed upon Army units having assigned, attached, or organic air defense weapons. Weapons control status terms are: weapons free, weapons tight, and weapons hold. (See also weapons free, weapons hold, and weapons tight.) See FMs 44-63 and 44-100.

airdrop (JP 1-02) — The unloading of personnel or materiel from aircraft in flight. (See also air movement.) See FMs 7-30, 55-12, 71-100-2, and JP 3-18.1.

airhead (JP 1-02, NATO) — **1.** A designated area in a hostile or threatened territory which, when seized and held, ensures the continuous air landing of troops and material and provides the maneuver space

OPERATIONAL TERMS AND GRAPHICS

necessary for projected operations. Normally it is the area seized in the assault phase of an airborne operation.

2. A designated location in an area of operations used as a base for supply and evacuation by air. (Army) — The airhead contains enough drop zones (DZs), landing zones (LZs), and extraction zones (EZs) to ensure mass, interior lines of communications, and defense in depth. (See also air assault and airborne operation.) See FMs 71-100-2, 90-4, and JP 3-18.1. **3-18**

airhead line — The limit of the objective area, assault objectives determine the size and shape of the airhead and the trace of the airhead line. (See also air assault and airborne operations) See FMs 7-30, 71-100-2, and JP 3-18.1. **3-18**

air interdiction (AI) (JP 1-02, NATO) — Air operations conducted to destroy, neutralize, or delay the enemy's military potential before it can be brought to bear effectively against friendly forces at such distance from friendly forces that detailed integration of each air mission with the fire and movement of friendly forces is not required. (Army) — Normally conducted forward of the land component commander's forward boundary. See FM 100-103.

air landed (JP 1-02, NATO) — Moved by air and disembarked, or unloaded, after the aircraft has landed or while a helicopter is hovering. (See also air assault and airborne operation.) See FMs 7-8, 7-10, 7-20, 7-30, 71-100-2, 71-100-3, 90-4, and 90-26.

air liaison officer (ALO) (JP 1-02) — An officer (aviator/pilot) attached to a ground unit who functions as the primary advisor to the ground commander on air operation matters. (Army) — The senior Air Force officer at each tactical air control party who provides advice on the capabilities, limitations, and employment of fixed wing aircraft and coordinates close air support missions with the fire support element. (See also tactical air control party (TACP).) See FMs 6-20 and 101-5.

air mission brief (AMB) — **1.** The last coordination meeting of key participants in an air assault operation which ensures that key aviation soldiers are briefed and that the plan is finalized. It covers the operation from beginning to end. **2.** Briefing of the pilots prior to any aviation mission. (See also abort criteria, air assault, airhead, and air mission commander (AMC).) See FMs 90-4, 71-100-3, and JP 3-18.1.

air mission commander (AMC) — Commander of the largest aviation unit supporting the air assault. He is responsible for all embarked soldiers and for coordinating all support from liftoff to touchdown. (See also abort criteria, air assault, and air mission brief (AMB).) See FMs 90-4, 71-100-3, and JP 3-18.1.

air movement (JP 1-02, NATO) — Air transport of units, personnel, supplies, equipment, and materiel. (See also aerial port of embarkation (APOE), aerial port of debarkation (APOD), air landed, and tanker airlift control element (TALCE).) See FMs 7-30, 55-12, 71-100-2, and JP 3-18.1.

air/naval gunfire liaison company (ANGLICO) (JP 1-02) — An organization composed of Marine and Navy personnel specially qualified for shore control of naval gunfire and close air support. See FM 71-100-2. **4-15**

air parity — The functional equivalency between enemy and friendly air forces in strength and capability to attack and destroy targets.

air reconnaissance (JP 1-02) — The acquisition of intelligence information by employing visual observation and/or sensors in air vehicles. (Army) — The use of air vehicles (fixed wing, rotary wing, or unmanned aerial vehicles) to obtain information concerning terrain, weather, and the disposition, composition, movement, installations, lines of communications, and electronic and communications emissions of

enemy forces. Also included are artillery and naval gunfire adjustment, and systematic and random observation of ground battle areas, targets, and/or sectors of airspace. (See also reconnaissance (recon, recce).)

airspace control area (ACA) (Army) — That airspace defined by the boundaries of the area of operations and which may be divided into airspace control subareas. See FM 100-103.

airspace control authority (ACA) (JP 1-02, NATO) — The commander designated to assume overall responsibility for the operation of the airspace control system in the airspace control area. (Army) — The joint force air component commander has responsibility for all airspace operations above the coordinating altitude and forward of the joint force land component commander's forward boundary, if so designated. See FMs 100-15 and 100-103.

airspace control in the combat zone (JP 1-02) — A process used to increase combat effectiveness by promoting the safe, efficient, and flexible use of airspace. Airspace control is provided in order to prevent fratricide, enhance air defense operations, and permit greater flexibility of operations. Airspace control does not infringe on the authority vested in commanders to approve, disapprove, or deny combat operations. (See also airspace control authority (ACA), airspace control order (ACO), and airspace coordination area (ACA).) See FM 100-103.

airspace control measures — Rules, mechanisms, and directions governed by joint doctrine and defined by the airspace control plan which control the use of airspace of specified dimensions. (See also high-density airspace control zone (HIDACZ), low-level transit route (LLTR), minimum-risk route (MRR), and standard use Army aircraft flight route (SAAFR).) See FM 100-103.

airspace control order (ACO) (JP 1-02) — An order implementing the airspace control plan that provides the details of the approved requests for airspace control measures. It is published either as part of the air tasking order or as a separate document. (Army) — It includes temporary airspace control measures and designates which organization is the controlling authority for each. See FMs 100-15 and 100-103.

airspace coordination area (ACA) (Army) — In fire support operations, a restrictive fire support coordination measure that establishes a three-dimensional block of airspace in the battle area in which friendly aircraft are reasonably safe from friendly surface fires. Aircraft and indirect fire are separated by time, space, or altitude. The purpose of the ACA is to allow the simultaneous attack of targets near each other by multiple fire support means, one of which normally is air. (See also Army airspace command and control (A²C²).) See FM 100-103 and JP 3-56. **3-21**

air strike (JP 1-02) — An attack on specific objectives by fighter, bomber, or attack aircraft on an offensive mission. May consist of several air organizations under a single command in the air. See FMs 71-100 and 100-15.

air superiority (JP 1-02, NATO) — That degree of dominance in the air battle of one force over another which permits the conduct of operations by the former and its related land, sea, and air forces at a given time and place without prohibitive interference by the opposing force.

air support (JP 1-02, NATO) — All forms of support given by air forces on land or sea. See FMs 71-100 and 100-15.

air support operations center (ASOC) (JP 1-02, NATO) — An agency of a tactical air control system collocated with a corps headquarters or an appropriate land force headquarters, which coordinates and directs close air support and other tactical air support.

OPERATIONAL TERMS AND GRAPHICS

- air supremacy** (JP 1-02, NATO) — That degree of air superiority wherein the opposing air force is incapable of effective interference.
- alliance** (JP1-02) — The result of formal agreements (for example, treaties) between two or more nations for broad, long-term objectives which further the common interests of the members. (See also coalition and multinational operations.) See FMs 100-5, 100-8, and JP 5-0.
- allocation** (JP 1-02) — In a general sense, distribution of limited resources among competing requirements for employment. Specific allocations (e.g., air sorties, nuclear weapons, forces, and transportation) are described as allocation of air sorties, nuclear weapons, etc. See FM 100-15.
- allowable load** (JP 1-02, NATO) — The total load that an aircraft can transport over a given distance, taking into account weight and volume. See FM 55-12.
- alternate command post** (JP 1-02) — Any location designated by a commander to assume command post functions in the event the command post becomes inoperative. It may be partially or fully equipped and manned or it may be the command post of a subordinate unit. (See also combat trains command post (CTCP), command post (CP), and tactical operations center (TOC).) See FMs 1-111, 6-20, 7-20, 7-30, 17-95, 71-100, 71-123, 100-15, and 101-5.
- alternate position** — The position given to a weapon, unit, or individual to be occupied when the primary position becomes untenable or unsuitable for carrying out its task. The alternate position is located so that the individual can continue to fulfill his original task. (See also primary position, successive positions, and supplementary position.) See FMs 7-7, 7-8, 7-10, 7-20, 7-30, 17-12, 17-95, 23-1, and 71-123.
- alternate supply route (ASR)** — A route or routes designated within an area of operations to provide for the movement of traffic when main supply routes become disabled or congested. (See also main supply route (MSR).) See FMs 17-95, 55-10, and 71-100. **3-40**
- ambulance exchange point (AXP)** (Army) — A location where a patient is transferred from one ambulance to another *en route* to a medical treatment facility. This may be an established point in an ambulance shuttle system or it may be designated independently. See FMs 8-10-1, 8-10-3, 8-10-4, 8-10-6, 63-2, and 63-20. **3-37**
- ambush** — A surprise attack by fire from concealed positions on a moving or temporarily halted enemy. See FMs 7-8, 7-20, 17-95, and 71-123. **3-19** **C-8**
- ammunition supply point (ASP)** — An area designated to receive, store, reconfigure, and issue class V material. It is normally located at or near the division area. See FM 9-6. **3-37** **A-6**
- ammunition transfer point (ATP)** — A designated, temporary site from which class V material is transferred from corps transportation to unit vehicles. See FMs 71-100 and 100-10. **3-37** **A-6**
- amphibious operation** (JP 1-02) — An attack launched from the sea by naval and landing forces embarked in ships or craft involving a landing on a hostile or potentially hostile shore. As an entity, the amphibious operation includes the following phases: **a. planning** — The period extending from issuance of the initiating directive to embarkation. **b. embarkation** — The period during which the forces, with their equipment and supplies, are embarked in the assigned shipping. **c. rehearsal** — The period during which the prospective operation is rehearsed for the purpose of: (1) testing adequacy of plans, the timing of detailed operations, and the combat readiness of participating forces; (2) ensuring that all echelons are

familiar with plans; and (3) testing communications. **d. movement** — The period during which various components of the amphibious task force move from points of embarkation to the objective area. **e. assault** — The period between the arrival of the major assault forces of the amphibious task force in the objective area and the accomplishment of the amphibious task force mission. See FM 71-100-2 and JP 3-02. **4-8** **5-7**

analysis and control element (ACE) (Army) — The G2's primary organization for controlling intelligence and electronic warfare (IEW) operations. The ACE performs collection management, produces all-source intelligence, provides IEW technical control, and disseminates intelligence and targeting data across the range of military operations. See FM 34-1.

analysis and control team (ACT) (Army) — An organic team within the direct support military intelligence company that provides the maneuver brigade S2 with automated intelligence processing, analytical, and dissemination capabilities. Unlike the analysis and control element at higher echelons, the ACT is not normally under operational control (OPCON) of the brigade S2.

antiterrorism (AT) (JP 1-02) — Defensive measures used to reduce the vulnerability of individuals and property to terrorist acts, to include limited response and containment by local military forces. (See also counterterrorism.) See FMs 31-20 and 100-20.

apportionment (JP 1-02) — In the general sense, distribution for planning of limited resources among competing requirements. Specific apportionments (e.g., air sorties and forces for planning) are described as apportionment of air sorties and forces for planning, etc. (Army) — The determination and assignment of the total expected effort by percentage or by priority that should be devoted to the various air operations or geographic areas for a given period of time. (See also allocation.) See FMs 100-103 and 100-15.

approach march (JP 1-02, NATO) — Advance of a combat unit when direct contact with the enemy is imminent. Troops are fully or partially deployed. The approach march ends when ground contact with the enemy is made or when the attack position is occupied. (Army) — A tactical movement that emphasizes speed over tactical deployment. It is used when the enemy's approximate location is known, allowing the attacking force to move with greater speed and less physical security or dispersion. The approach march terminates in an attack position, assembly area, or assault position or can be used to transition to an attack. Follow and assume and reserve forces may also conduct an approach march. (See also movement to contact.) See FMs 7-7, 7-8, 7-10, 7-20, 7-30, 17-95, 71-100, 71-123, and 100-15.

area air defense commander (AADC) (JP1-02) — Within a unified command, subordinate unified command, or joint task force, the commander will assign overall responsibility for air defense to a single commander. Normally, this will be the component commander with the preponderance of air defense capability and the command, control, and communications capability to plan and execute integrated air defense operations. Representation from the other components involved will be provided, as appropriate, to the AADC's headquarters. See JP 3-12.1.

area assessment (Army) — In unconventional warfare, the collection of specific information prescribed by the commander to commence immediately after infiltration. It is a continuous operation, and it confirms, corrects, refutes, or adds to intelligence acquired from area studies and other sources prior to infiltration.

area command (JP 1-02, NATO) — A command which is composed of those organized elements of one or more of the armed services, designated to operate in a specific geographical area, which are placed under a single commander. (Army) — In unconventional warfare, the organizational structure established within a joint special operations area to command and control resistance forces. It consists of the area

OPERATIONAL TERMS AND GRAPHICS

commander, his staff, and representatives of the resistance element, to include Special Forces after infiltration. See FMs 31-20, 100-5, and 100-15.

area damage control (ADC) (JP 1-02, NATO) — Measures taken before, during, or after hostile action or natural or manmade disasters, to reduce the probability of damage and minimize its effects. (Army) — The process includes continuous planning and actions designed to minimize damages and a systematic approach to resolving the impact damages have on operations. (See also rear operations.) See FMs 71-100, 100-7, and 100-15.

area defense — A form of defense that focuses on denying the enemy access to designated terrain for a specified time, rather than on the outright destruction of the enemy. A commander may conduct an area defense by using mutually supporting positions in depth. (See defensive operations.) See FMs 7-7, 7-8, 7-10, 7-20, 7-30, 17-95, 71-100, 71-123, and 100-15.

area of influence (JP 1-02, NATO) — A geographical area wherein a commander is directly capable of influencing operations by maneuver or fire support systems normally under the commander's command or control. (Army) — It includes both organic and supporting combat power, to include joint, multinational, or interagency assets.

area of intelligence responsibility — An area allocated to a commander in which the commander is responsible for providing intelligence within the means at the commander's disposal.

area of interest (AOI) (JP 1-02, NATO) — That area of concern to the commander, including the area of influence, areas adjacent thereto, and extending into enemy territory to the objectives of current or planned operations. This area also includes areas occupied by enemy forces which could jeopardize the accomplishment of the mission. (Army) — A geographical area from which information and intelligence are required to execute successful tactical operations and to plan for future operations. It includes any threat forces or characteristics of the battlefield environment that will significantly influence accomplishment of the command's mission. (See also area of operations (AO) and battlespace.) See FMs 34-130, 71-100, and 100-15.

area of limitation — A defined area where specific limitations apply to the strength and fortifications of disputing or belligerent forces. Normally, upper limits are established for the number and type of formations, tanks, antiaircraft weapons, artillery, and other weapons systems in the area of limitation.

area of operations (AO) (JP 1-02) — An operational area defined by the joint force commander for land and naval forces. Areas of operation do not typically encompass the entire operational area of the joint force commander, but should be large enough for component commanders to accomplish their missions and protect their forces. (Army) — A geographical area, including the airspace above, usually defined by lateral, forward, and rear boundaries assigned to a commander, by a higher commander, in which he has responsibility and the authority to conduct military operations. (See also area of interest (AOI) and battlespace.) See FMs 34-130, 71-100, 100-5, 100-15, 100-20, and JP 5-0. **3-19**

area reconnaissance — A form of reconnaissance operations that is a directed effort to obtain detailed information concerning the terrain or enemy activity within a prescribed area, such as a town, ridgeline, woods, or other feature critical to operations. An area reconnaissance could be made of a single point, such as a bridge or installation. (See also reconnaissance (recon, recce).) See FMs 1-111, 1-114, 7-20, 7-30, 17-95, 71-100, 71-123, 100-15, and 101-5.

area of responsibility (AOR) (JP 1-02) — **1.** The geographical area associated with a combatant command within which a combatant commander has authority to plan and conduct operations. **2.** In naval usage, a predefined area of enemy terrain for which supporting ships are responsible for covering by fire on

known targets or targets of opportunity and by observation. See FMs 1-111, 7-20, 7-30, 17-95, 71-100, 71-123, 100-5, 100-15, 101-5, and JP 0-2.

area security — A form of security operations that includes area reconnaissance, rear operations, and security of designated personnel, unit convoys, facilities, and main supply route critical points. (See also area reconnaissance and rear operations.) See FMs 17-95, 19-1, and 71-100.

area support — Method of logistics and combat health support in which direct support (DS) combat service support relationships in effect are determined by the location of the units requiring support. Subordinate DS units provide area support to units located in or passing through their areas of responsibility. (See also area of responsibility (AOR).) See FMs 8-10, 8-10-1, 8-10-4, 8-10-9, 8-10-24, 10-1, and 100-10.

4-24

armed reconnaissance (JP 1-02) — A mission with the primary purpose of locating and attacking targets of opportunity, i.e., enemy materiel, personnel, and facilities, in assigned general areas or along assigned ground communications routes, and not for the purpose of attacking specific briefed targets.

armistice demarcation line (Army) — A geographically defined line from which disputing or belligerent forces disengage and withdraw to their respective sides following a truce or cease fire agreement. It is also called cease fire in some United Nations operations.

Army airspace command and control (A²C²) (Army) — The Army's application of airspace control to coordinate airspace users for concurrent employment in the accomplishment of assigned missions. (See also airspace control order (ACO).) See FM 100-103.

Army forces (ARFOR) (Army) — The Army forces headquarters and or forces provided by the Army service component to the joint force commander for the conduct of joint operations. (See also land component commander (LCC) and joint force land component commander (JFLCC).) See FMs 71-100, 100-5, 100-15, and JP 3-0.

Army service component commander (ASCC) (Army) — Serves as the principal advisor to the commander in chief for supporting and employing Army forces (ARFOR) in theater and forces outside the theater tasked to support theater operations. His command consists of those Army individuals, units, detachments, organizations, and installations. He is responsible for all command aspects of the ARFOR, to include logistics within the unified command. (See also Army forces (ARFOR).) See FM 100-7.

A-1

Army special operations forces (ARSOF) (JP 1-02) — Those active and reserve component Army forces designated by the Secretary of Defense that are specifically organized, trained, and equipped to conduct and support special operations.

Army war reserve stock (Army) — Materiel amassed in peacetime to meet the increase in military requirements at the outbreak of war.

artillery preparation — Artillery fire delivered before an attack to destroy, neutralize, or suppress the enemy's defense and to disrupt communications and disorganize the enemy's defense. The preparation is planned by a direct support field artillery battalion or higher echelon in coordination with the ground commander. It is an intense volume of fire delivered in accordance with a time schedule. The fires normally commence prior to H-hour and may extend beyond it. They may start at a prescribed time or be held on call. The duration of the preparation is influenced by factors such as the fire support needs of the entire force, number of targets and firing assets, and available ammunition. See FMs 6-20-30 and 71-123.

OPERATIONAL TERMS AND GRAPHICS

assailable flank(s) — An exposed flank(s) which is vulnerable to envelopment. For a flank to be assailable, there must be sufficient maneuver space to accommodate the attacking force. See FMs 17-95, 71-100, 71-123, and 100-15.

assault (JP 1-02) — **1.** The climax of an attack, closing with the enemy in hand-to-hand fighting. **2.** In an amphibious operation, the period of time between the arrival of the major assault forces of the amphibious task force in the objective area and the accomplishment of the amphibious task force mission. **3.** To make a short, violent, but well-ordered attack against a local objective, such as a gun emplacement, a fort, or a machine gun nest. **4.** A phase of an airborne operation beginning with delivery by air of the assault echelon of the force into the objective area and extending through attack of assault objectives and consolidation of the initial airhead. (See also assault force and assault phase). (Army) — **1.** The culmination of an attack which closes with the enemy. **2.** In an amphibious operation, the period of time from the crossing of the line of departure by the first scheduled wave to the seizure of the initial objectives. **3.** A phase of an airborne or air assault operation beginning with delivery of the assault force into the objective area and extending through the attack of objectives and consolidation of the initial airhead. **4.** To make a short, violent, but well-ordered attack against a local objective, such as a gun emplacement or fortified area. See FMs 7-8, 7-30, 17-95, 71-100, 71-123, 100-5, and 100-15.

assault breach — A breach tactic used by small units (company, teams, and platoons) to penetrate an enemy's protective obstacles and seize a foothold within his defense. It is normally a very decentralized operation with suppress, obscure, secure, and reduce (SOSR) actions synchronized at the platoon and company level. (See also in-stride breach.) See FMs 5-71-100 and 90-13-1.

assault command post (Army) — An austere, temporary command post established to perform critical command and control functions. The assault command post serves as the early link in the assault or deployment between the forces on the ground and the next higher tactical force headquarters. Doctrinal command post functions are passed to the tactical, main, and rear command posts when they arrive and become operational. (See also command post (CP).) See FMs 7-30, 71-100-2, and 71-100-3. **A-2**

assault echelon (NATO) — The element of a force that is scheduled for initial assault on the objective area. (See also follow-on echelon and rear echelon.) See FMs 71-100-2, 71-100-3, 90-26, and JP 3-18.1.

assault fire (JP 1-02) — **1.** That fire delivered by attacking troops as they close with the enemy. **2.** In artillery, extremely accurate, short-range destruction fire at point targets. See FMs 7-8 and 71-123.

assault force — **1.** In an amphibious, airborne, or air assault operation, those units charged with the seizure of the objective or lodgment area. **2.** Those forces charged with passing through a breach in an enemy fortified position or strongpoint and seizing an objective or completing destruction of the enemy. **3.** Those forces charged with seizure of the objective in the attack. (See also breach force and support force.) See FMs 7-30, 71-100-2, 71-100-3, 71-123, 90-13, and 90-13-1.

assault phase (JP 1-02, NATO) — **1.** In an amphibious operation, the period of time between the arrival of the major assault forces of the amphibious task force in the objective area and the accomplishment of their mission. **2.** In an airborne operation, a phase beginning with delivery by air of the assault echelon of the force into the objective area and extending through attack of assault objectives and consolidation of the initial airhead. (Army) — **1.** That phase of an airborne, air assault, or amphibious or river crossing operation that begins with the delivery of the assault forces into the objective area and ends when all assault objectives have been seized. **2.** That period during an attack which begins when the assault forces advance from their assault position and ends when the objective has been seized and consolidated. (See also air assault, airborne operation, amphibious operation, and river crossing.) See FMs 7-30, 71-100-2, and 71-100-3.

assault position — That position between the line of departure and the objective in an attack from which forces assault the objective. Ideally, it is the last covered and concealed position before reaching the objective. (See **limit of advance (LOA)** and **probable line of deployment (PLD)**.) See FMs 7-8, 7-20, and 71-123. **3-14**

assembly area (AA) (JP 1-02, NATO) — **1.** An area in which a command is assembled preparatory to further action. **2.** In a supply installation, the gross area used for collecting and combining components into complete units, kits, or assemblies. See FMs 7-20, 7-30, and 71-123. **3-10**

asset (intelligence) (JP 1-02) — Any resource—person, group, relationship, instrument, installation, or supply — at the disposition of an intelligence organization for use in an operational or support role. Often used with a qualifying term such as agent asset or propaganda asset. See FM 31-20.

assign (JP 1-02, NATO) — **1.** To place units or personnel in an organization where such placement is relatively permanent, and/or where such organization controls and administers the units or personnel for the primary function, or greater portion of the functions, of the unit or personnel. **2.** To detail individuals to specific duties or functions where such duties or functions are primary and/or relatively permanent. (See also **attach**.) See FM 101-5.

attach (JP 1-02) — **1.** The placement of units or personnel in an organization where such placement is relatively temporary. **2.** The detailing of individuals to specific functions where such functions are secondary or relatively temporary, e.g., attached for quarters and rations; attached for flying duty. (Army) — Subject to limitations imposed by the attachment order, the commander of the formation, unit, or organization receiving the attachment has the responsibility to provide the attached units with sustainment support above its organic capability. However, the responsibility for transfer, promotion of personnel, nonjudicial punishment, courts martial, and administrative actions, such as SIDPERS transactions and unit strength reporting, are normally retained by the parent formation, unit, or organization. (See also **assign**, **operational command (OPCOM)**, **operational control (OPCON)**, and **organic**.) See FM 101-5.

attack — A form of offensive operation characterized by coordinated movement supported by fire. It may be designated as a main or a supporting attack. The principal attack options include hasty attack, deliberate attack, spoiling attack, counterattack, raid, feint, and demonstration. (See also **counterattack**, **deliberate attack**, **demonstration**, **feint**, **hasty attack**, **offensive operations**, **raid**, and **spoiling attack**.) See FMs 1-111, 6-20, 7-20, 7-30, 17-95, 71-100, 71-123, 100-15, and 101-5.

attack by fire — Fires (direct and indirect) employed to destroy the enemy from a distance, normally used when the mission does not dictate or support occupation of the objective. This task is usually given to the supporting element during the offensive and as a counterattack option for the reserve during defensive operations. An attack by fire is not done in conjunction with a maneuvering force. When assigning this task, the commander must specify the intent of fire — either to destroy, fix, or suppress. (See also **frontal attack** and **support by fire**.) See FMs 7-8, 7-20, 7-30, and 71-123. **3-14** **C-8**

attack operations — Offensive actions intended to destroy and disrupt enemy theater missile (TM) capabilities before, during, and after launch. The objective of attack operations is to prevent the launch of TMs by attacking each element of the overall system, including such actions as destroying launch platforms, RSTA platforms, C² nodes, and missile stocks and infrastructure. See JP 3-01.5.

attack position (JP 1-02) — The last position occupied by the assault echelon before crossing the line of departure. (See also **assault position**.) See FMs 7-8, 7-20, 7-30, and 71-123. **3-14**

OPERATIONAL TERMS AND GRAPHICS

attrition (JP 1-02, NATO) — The reduction of the effectiveness of a force caused by loss of personnel and materiel. See FMs 7-8, 7-20, 7-30, 71-123, and 100-5.

augmentation forces (JP 1-02) — Forces to be transferred from a supporting commander to the combatant command (command authority) or operational control of a supported commander during the execution of an operation order approved by the National Command Authorities. (Army) — Forces which are required for specific missions but are not required for day-to-day operations. A command relationship will be specified when these forces are transferred. See FMs 71-100, 100-15, and JP 5-0.

authenticate (JP 1-02) — A challenge given by voice or electrical means to attest to the authenticity of a message or transmission.

authentication (JP 1-02) — **1.** A security measure designed to protect a communications system against acceptance of a fraudulent transmission or simulation by establishing the validity of a transmission, message, or originator. **2.** A means of identifying individuals and verifying their eligibility to receive specific categories of information. **3.** Evidence by proper signature or seal that a document is genuine and official. **4.** In evasion and recovery operations, the process whereby the identity of an evader is confirmed.

authorized stockage list (ASL) (Army) — A list of items from all classes of supply authorized to be stocked at a specific echelon of supply. See FMs 10-1 and 100-10.

automatic resupply (JP 1-02) — A resupply mission fully planned before insertion of a special operations team into the operations area that occurs at a prearranged time and location, unless changed by the operating team after insertion. (See also emergency resupply and on-call resupply.)

auxiliary — In unconventional warfare, that element of the resistance force established to provide the organized civilian support of the resistance movement.

avenue of approach (AA) (JP 1-02) — An air or ground route of an attacking force of a given size leading to its objective or to key terrain in its path. (See also intelligence preparation of the battlefield (IPB).) See FMs 7-8, 7-20, 7-30, 34-130, 44-100, 71-123, and 100-5.

aviation combat element (ACE) (JP 1-02) — The Marine air-ground task force (MAGTF) element that is task organized to provide all or a portion of the functions of Marine Corps aviation in varying degrees based on the tactical situation and the MAGTF mission and size. These functions are air reconnaissance, antiair warfare, assault support, offensive air support, electronic warfare, and control of aircraft and missiles. The ACE is organized around an aviation headquarters and varies in size from a reinforced helicopter squadron to one or more Marine aircraft wing(s). It includes those aviation command (including air control agencies), combat, combat support, and combat service support units required by the situation. Normally, there is only one ACE in a MAGTF.

axis of advance (JP 1-02) — A line of advance assigned for purposes of control; often a road or a group of roads, or a designated series of locations, extending in the direction of the enemy. (Army) — A general route of advance, assigned for purposes of control, which extends toward the enemy. An axis of advance symbol graphically portrays a commander's intention, such as avoidance of built-up areas or envelopment of an enemy force. It follows terrain suitable for the size of the force assigned the axis and is often a road, a group of roads, or a designated series of locations. A commander may maneuver his forces and supporting fires to either side of an axis of advance provided the unit remain oriented on the axis and the objective. Deviations from an assigned axis of advance must not interfere with the maneuver of adjacent units without prior approval of the higher commander. Enemy forces that do not threaten security or jeopardize mission accomplishment may be bypassed. An axis of advance is not used to direct the control

of terrain or the clearance of enemy forces from specific locations. Intermediate objectives normally are assigned for these purposes. (See also attack, direction of attack, movement to contact, and offensive operations.) See FMs 7-20, 7-30, 17-95, 71-100, 71-123, and 100-15. **3-14, 3-15**

azimuth (JP 1-02) — Quantities may be expressed in positive quantities increasing in a clockwise direction, or in X, Y coordinates where south and west are negative. They may be referenced to true north or magnetic north depending on the particular weapon system used. (Army) — The horizontal angle, measured clockwise by degrees or mils between a reference direction and the line to an observed or designated point. There are three base (reference) directions or azimuths: true, grid, and magnetic azimuth. (See also grid azimuth, magnetic azimuth, and true azimuth.) See FM 21-26.

azimuth angle (JP 1-02, NATO) — An angle measured clockwise in the horizontal plane between a reference direction and any other line.

B

backbrief — A briefing by subordinates to the commander to review how subordinates intend to accomplish their mission. This is a commander to commander or one on one briefing. It takes two forms: **1.** After the operation order to ensure a subordinate's understanding of the mission. **2.** When a single commander briefs how he will accomplish the mission. (See also confirmation brief.) See FM 101-5

backhaul — The use of transportation assets that, having deposited their primary loads, are available to remove personnel and materials from that location to another location *en route* to their return destination. See FMs 19-1 and 100-10.

ballistic missile (JP 1-02, NATO) — Any missile which does not rely upon aerodynamic surfaces to produce lift and consequently follows a ballistic trajectory when thrust is terminated.

barrage fire (JP 1-02, NATO) — Fire which is designed to fill a volume of space or area rather than aimed specifically at a given target. (See also call for fire.) See FM 6-series.

barrage jamming (JP 1-02) — Simultaneous electromagnetic jamming over a broad band of frequencies. (See also jamming.) See FMs 34-1 and 34-10.

barrier (JP 1-02) — A coordinated series of obstacles designed or employed to channel, direct, restrict, delay, or stop the movement of an opposing force and to impose additional losses in personnel, time, and equipment on the opposing force. Barriers can exist naturally, be manmade, or a combination of both. (See also abatis, countermobility operations, and obstacle.) See FM 5-102.

base (JP 1-02, NATO) — **1.** A locality from which operations are projected or supported. **2.** An area or locality containing installations which provide logistic or other support. (DOD) **3.** Home airfield or home carrier. (Army) — A grouping of units or activities within a defined, defensible perimeter with specific access control points and traffic control. All units or activities are under operational control of a single commander for security operations. See FMs 100-10 and 100-15.

base camp closure standards — Specific criteria (including both environmental, and nonenvironmental, protection issues) to be met when preparing to close, and on closing a base camp area. The addressing of each criterion is specified in its timing, and area of focus. The areas include identifying hazardous wastes and materials to be retrograded; conducting site assessments; identifying areas of POL contamination; completing and submitting an environmental condition report; having legal

OPERATIONAL TERMS AND GRAPHICS

representatives begin settling claims from local property owners; and conducting turnover meeting with lawyer, real estate representative, engineer, and so forth.

base cluster (JP 1-02) — In base defense operations, a collection of bases, geographically grouped for mutual protection and ease of command and control. (Army) — A grouping of bases designed to enhance the rear operations commander's span of control. Base clusters do not have a defined single perimeter or established access points for the whole cluster. All bases within the cluster are under operational control of a single commander for security operations. (See also base.) See FMs 71-100, 100-10, 100-15, and 100-16.

base cluster operations center (BCOC) (JP 1-02) — A command and control facility that serves as the base cluster commander's focal point for defense and security of the base cluster. (Army) — An austere command post established by the base cluster commander to coordinate security requirements between bases and conduct limited security operations. See FMs 71-100-1/2/3 and 100-15-1.

base defense (JP 1-02) — The local military measures, both normal and emergency, required to nullify or reduce the effectiveness of enemy attacks on, or sabotage of, a base, to ensure that the maximum capacity of its facilities is available to US forces.

base defense operations — The local military measures, both normal and emergency, required to nullify or reduce the effectiveness of enemy attacks on, or sabotage of, a base to ensure that the maximum capacity of its facilities is available to US forces. (See also base, base cluster, and defend.) See FMs 100-10 and 100-15.

base defense operations center (BDOC) (JP 1-02) — A command and control facility established by the base commander to serve as the focal point for base security and defense. It plans, directs, integrates, coordinates, and controls all base defense efforts, and coordinates and integrates into area security operations with the rear area operations center/rear tactical operations center. (Army) — An austere command post established by the base commander to plan, coordinate, and supervise base defense operations to ensure the protection of personnel, equipment, and resources from enemy attack. See FMs 71-100-1/2/3 and 100-15-1. **A-2**

base defense reaction forces — Forces comprised of personnel or elements of units assigned to a specific base with the responsibility to rapidly bolster base defenses or react to an unforeseen threat. See FMs 71-100-1/2/3 and 100-15-1.

base defense status (Army) — A two-digit indicator determined by assessing the development of defenses coupled with the percentage of personnel manning the perimeter. The first digit is alphabetic (A-G) and corresponds to the development of the base defenses. The second digit is numeric (1-9) and corresponds to the percentage of soldiers physically manning the perimeter. See FMs 71-100, 71-100-1/2/3, 100-15, and 100-15-1.

base defense zone (BDZ) (JP 1-02) — An air defense zone established around an air base and limited to the engagement envelope of short-range air defense weapons systems defending that base. Base defense zones have specific entry, exit, and identification, friend or foe procedures established. (See also air defense and base defense.) See FMs 44-100 and 100-15.

base development (JP 1-02, NATO) — The improvement or expansion of the resources and facilities of an area or a location to support military operations. (See also base.) See FMs 100-10 and 100-15.

base element — *See* base unit.

base of fire— Continuous and active suppression from a support-by-fire position of an objective (even though the enemy has not shown himself) to reduce or eliminate the enemy's capability to interfere by fire and movement with an assaulting unit. It may be provided by a single weapon or a grouping of weapon systems. (See also overwatch and support by fire). See FMs 7-7, 7-20, and 71-123.

base unit (JP1-02) — Unit of organization in a tactical operation around which a movement or maneuver is planned and performed. See FMs 7-7 and 7-20.

basic load (JP 1-02, NATO) —The quantity of supplies required to be on hand within, and which can be moved by, a unit or formation. It is expressed according to the wartime organization of the unit or formation and maintained at the prescribed levels. (Army) — The quantity of supplies and ammunition stored and carried under an organization's control that is determined by a higher headquarters on the basis of the mission and analysis of the threat. See FMs 6-20, 7-7, 7-20, 71-123, and 100-10.

battalion task force — **1.** Based upon mission, a temporary grouping of units under one commander formed to carry out a specific operation or mission. **2.** A semipermanent organization of units under one commander, formed for the purpose of carrying out a continuing specific task. **3.** A combat arms battalion-sized unit consisting of a battalion headquarters, at least one assigned company-sized element, and at least one attached company-sized element from another combat arm or combat support unit. (See also task force and task organization.) See FM 71-123.

battle — A series of related tactical engagements that last longer than an engagement, involve larger forces, and could affect the course of the campaign. They occur when division, corps, or army commanders fight for significant objectives. (See also campaign, engagement, and major operation.) See FM 100-5.

battle command (BC) (Army) — The art of battle decision making and leading. It includes controlling operations and motivating soldiers and their organizations into action to accomplish missions. Battle command includes visualizing the current state and a future state, then formulating concepts of operations to get from one to the other at least cost. It also includes assigning missions, prioritizing and allocating resources, selecting the critical time and place to act, and knowing how and when to make adjustments during the fight. See FM 100-5.

battle damage assessment (BDA) (JP 1-02) (NATO: damage assessment) — The timely and accurate estimate of damage resulting from the application of military force, either lethal or nonlethal, against a predetermined objective. Battle damage assessment can be applied to the employment of all types of weapon systems (air, ground, naval, and special forces weapon systems) throughout the range of military operations. It is primarily an intelligence responsibility with required inputs and coordination from the operators. It is composed of physical damage assessment, functional damage assessment, and target system assessment. See FMs 6-20-10, 34-1, 34-130, 71-100, and 100-15.

battle damage assessment and repair (BDAR) (NATO: battle damage repair) — Any expedient action that returns a damaged item or assembly to a mission-capable or limited mission-capable condition. Repairs are often temporary. (See also cannibalize.) See FMs 63-2 and 100-9.

battle drill — Standardized actions made in response to common battlefield occurrences. They are designed for rapid reaction situations. See FMs 7-7, 7-8, 7-10, 17-15, and 17-98.

battlefield circulation control (BCC) (Army) — A military police mission involving route reconnaissance and surveillance, main supply route regulation enforcement, straggler and refugee control, intelligence collecting and reporting, and information dissemination. See FM 19-1.

OPERATIONAL TERMS AND GRAPHICS

battlefield coordination detachment (BCD) (JP 1-02) — An Army liaison provided by the Army component commander to the Air Operations Center (AOC) and/or to the component designated by the joint force commander to plan, coordinate, and deconflict air operations. The battlefield coordination element processes Army requests for tactical air support, monitors and interprets the land battle situation for the AOC, and provides the necessary interface for exchange of current intelligence and operational data. See FMs 71-100, 100-13, and 100-15.

battlefield framework — The overall structure of the battlefield which, at the tactical level of war, consists of four interrelated concepts: area of interest, battlespace, area of operations, and battlefield organization. The battlefield framework provides a way for commanders to relate their forces to the enemy in terms of time, space, and purpose. This battlefield framework applies to both linear and noncontiguous operations. (See also area of influence, area of interest, area of operations, and battlespace.) See FM 71-100, 100-5, and 100-15.

battlefield information coordination center (BICC) (Army) — A subsection of the battalion and brigade S2 section. It provides detailed control and coordination of intelligence collection, production, and dissemination, thus freeing the S2 from routine tasks so that he can better manage the overall intelligence effort.

battlefield operating systems (BOS) (Army) — A listing of critical tactical activities. The BOS provide a means of reviewing preparations or execution in discrete subsets. Critical to this review is the synchronization and coordination of activities not only within a BOS, but among the various BOS. The BOS are not all inclusive; they include intelligence, maneuver, fire support, mobility and survivability, air defense, combat service support, and command and control but do not address timing, tempo, reconnaissance, information operations, or tactics.

battlefield organization — The arranging and synchronizing of battlefield activities throughout the area of operations to accomplish the simultaneous operations of deep, close, and rear. (See also close operations, deep operations, rear operations, and simultaneous attack in depth.) See FMs 71-100, 100-5, and 100-15.

battlefield visualization (Army) — The process whereby the commander develops a clear understanding of his current state with relation to the enemy and environment, envisions a desired end state, and then subsequently visualizes the sequence of activity that will move his force from its current state to the end state. The commander articulates a battlefield vision through an intent statement which guides the development of a concept for the operation and subsequent execution of the mission. (See also branch, concept of operations, sequel, and wargaming.) See FMs 71-100, 100-5, and 100-15.

battle handover — A designated point (phase line) on the ground where responsibility transitions from the stationary force to the moving force and vice versa. It is within direct fire range and observed indirect fire range of the stationary force. (See also support by fire.) See FMs 17-95, 71-100, 71-123, and 100-15.

battle position (BP) — **1.** A defensive location oriented on the most likely enemy avenue of approach from which a unit may defend. Such units can be as large as battalion task forces and as small as platoons. A unit assigned a BP is located within the general outline of the BP. A battle position graphic control measure may be used independently or in combination with sectors. Security, combat support, and combat service support forces may operate outside a BP. **2.** For attack helicopters, an area designated in which they can maneuver and fire into a designated engagement area or engage targets of opportunity. (See also defend.) See FMs 1-112, 7-8, 7-20, 7-30, and 71-123. **3-8**

battlespace (Army) — The conceptual physical volume in which the commander seeks to dominate the enemy. It expands and contracts in relation to the commander's ability to acquire and engage the enemy,

or can change as the commander's vision of the battlefield changes. It encompasses three dimensions and is influenced by the operational dimensions of time, tempo, depth, and synchronization. It is not assigned by a higher commander nor is it constrained by assigned boundaries. (See also battlefield framework.) See FMs 71-100, 100-5, and 100-15.

beach capacity (JP 1-02, NATO) — An estimate, expressed in terms of measurement tons, or weight tons, of cargo that may be unloaded over a designated strip of shore per day.

beachhead (JP 1-02) — A designated area on a hostile or potentially hostile shore that, when seized and held, ensures the continuous landing of troops and materiel, and provides maneuver space requisite for subsequent projected operations ashore. (See also amphibious operation.) See FMs 31-12, 71-100, 71-100-2, 100-5, and JP 3-02.

beaten zone (JP 1-02) — The area on the ground upon which the cone of fire falls. See FMs 6-20, 7-8, and 7-90.

begin morning civil twilight (BMCT) — Begins when the sun is halfway between beginning morning and nautical twilight and sunrise, when there is enough light to see objects clearly with the unaided eye. At this time, light intensification devices are no longer effective, and the sun is six degrees below the eastern horizon.

begin morning nautical twilight (BMNT) — The start of that period where, in good conditions and in the absence of other illumination, enough light is available to identify the general outlines of ground objects and conduct limited military operations. Light intensification devices are still effective and may have enhanced capabilities. At this time, the sun is 12 degrees below the eastern horizon. (See also twilight.)

beleaguered — *See* missing.

be-prepared mission (Army) — A mission assigned to a unit that might be executed. It is generally a contingency mission which will be executed because something planned has or has not been successful. In planning priorities, it is planned after any on-order missions. (See also on-order mission.) See FM 101-5.

beseiged — *See* missing.

biological agent (JP 1-02) — A microorganism that causes disease in personnel, plants, or animals or causes the deterioration of materiel. See FMs 3-9 and 8-10-7.

biological operation (JP 1-02, NATO) — Employment of biological agents to produce casualties in personnel or animals and damage to plants or materiel; or defense against such employment. See FM 3-9.

biosurveillance — The systematic observation of an area of operations for biological hazards. This includes the use of biodetectors, intelligence, LB teams, and other resources.

black list (JP 1-02) — An official counterintelligence listing of actual or potential enemy collaborators, sympathizers, intelligence suspects, and other persons whose presence menaces the security of friendly forces. **D-3**

black propaganda (JP 1-02) — Propaganda which purports to emanate from a source other than the true one. (See also information warfare (IW).)

OPERATIONAL TERMS AND GRAPHICS

blast effect (JP 1-02) — Destruction of or damage to structures and personnel by the force of an explosion on or above the surface of the ground. Blast effect may be contrasted with the cratering and ground-shock effects of a projectile or charge that goes off beneath the surface. See FM 5-250 and JPs 3-12.2, and 3-12.3.

blind transmission (JP 1-02) — Any transmission of information that is made without expectation of acknowledgement.

blister agent (JP 1-02, NATO) — A chemical agent which injures the eyes and lungs, and burns or blisters the skin. Also called vesicant agent. See FM 3-9.

block — **1.** A tactical task assigned to a unit that requires it to deny the enemy access to a given area or to prevent enemy advance in a given direction or an avenue of approach. It may be for a specified time. Units assigned this mission may have to retain terrain and accept decisive engagement. **2.** An obstacle effect that integrates fire planning and obstacle effort to stop an attacker on a specific avenue of approach or to prevent an enemy from exiting an engagement area. (See also contain, disrupt, fix, and turn.) See FMs 5-71-100, 5-102, and 90-7. **3-31** **C-8**

blocking position (JP 1-02, NATO) — A defensive position so sited as to deny the enemy access to a given area or to prevent his advance in a given direction. (See also battle position (BP), block, defend, and strongpoint (SP).) See FMs 5-102, 5-103, 7-20, 71-100, and 71-123.

blood agent (JP 1-02, NATO) — A chemical compound, including the cyanide group, that affects bodily functions by preventing the normal utilization of oxygen by body tissues. See FM 3-9.

blood chit (JP 1-02) — A small sheet of material depicting an American Flag and a statement in several languages to the effect that anyone assisting the bearer to safety will be rewarded. (See also civil affairs.) See FM 1-111.

blowback (JP 1-02, NATO) — **1.** Escape, to the rear and under pressure, of gases formed during the firing of the weapon. Blowback may be caused by a defective breech mechanism, a ruptured cartridge case, or a faulty primer. **2.** Type of weapon operation in which the force of expanding gases acting to the rear against the face of the bolt furnishes all the energy required to initiate the complete cycle of operation. A weapon which employs this method of operation is characterized by the absence of any breech-lock or bolt-lock mechanism. (Army) — A recoilless weapon is characterized by this type functioning. See FMs 7-8, 17-12, and 23-1.

bogey (JP 1-02) — An air contact which is unidentified but assumed to be enemy. (Not to be confused with unknown.) (See also hostile criteria.) See FMs 44-100 and 100-103.

booby trap (JP 1-02, NATO) — An explosive or nonexplosive device or other material deliberately placed to cause casualties when an apparently harmless object is disturbed or a normally safe act is performed. (Army) — A device designed to kill or maim an unsuspecting person who disturbs an apparently harmless object or performs a normally safe act. **3-27** **D-3**

bound (JP 1-02, NATO) — **1.** In land warfare, a single movement, usually from cover to cover, made by troops often under enemy fire. (DOD) **2.** Distance covered in one movement by a unit that is advancing by bounds. (See also movement technique.) See FMs 1-111, 7-8, 7-20, 17-95, and 71-123.

boundary (JP 1-02) — A line which delineates surface areas for the purpose of facilitating coordination and deconfliction of operations between adjacent units, formations, or areas. (Army) — **1.** A control measure

used to define the right, left, rear, and forward limits of an area of operation. **2.** A control measure normally drawn along identifiable terrain features and used to delineate areas of tactical responsibility between adjacent units and between higher headquarters to the rear of subordinate units. Within their boundaries, units may maneuver within the overall plan without close coordination with neighboring units unless otherwise restricted. Direct fire may be placed across boundaries on clearly identified enemy targets without prior coordination, provided friendly forces are not endangered. Indirect fire also may be used after prior coordination. (See also airhead, airspace coordination area (ACA), area of operations (AO), and bridgehead.) **3-11**

bounding overwatch — A movement technique used when contact with enemy forces is expected. The unit moves by bounds. One element is always halted in position to overwatch another element while it moves. The overwatching element is positioned to support the moving unit by fire or fire and movement. (See also movement technique and overwatch.) See FMs 7-8, 7-20, and 71-123.

box formation — A unit formation with subordinate elements arranged in a box or square or two elements up and two back. It is a flexible formation that provides equal fire power in all directions. It is generally used when the enemy location is known. This formation can cause 50 percent of force to be decisively engaged at the same time, therefore limiting the combat power available to maneuver against an enemy. (See also column formation, echelon formation, formation, line formation, movement formation, vee formation, and wedge formation.) See FMs 7-7, 7-8, and 7-20.

bracketing (JP 1-02, NATO) — A method of adjusting fire in which a bracket is established by obtaining an over and a short along the spotting line, and then successively splitting the bracket in half until a target hit or desired bracket is obtained. (See also call for fire.) See FMs 6-20 and 7-90.

branch (JP 1-02) — **1.** A subdivision of any organization. **2.** A geographically separate unit of an activity which performs all or part of the primary functions of the parent activity on a smaller scale. Unlike an annex, a branch is not merely an overflow addition. **3.** An arm or service of the Army. (Army) — A contingency plan or course of action (an option built into the basic plan or course of action) for changing the mission, disposition, orientation, or direction of movement of the force to aid success of the operation based on anticipated events, opportunities, or disruptions caused by enemy actions and reactions as determined during the wargaming process. (See also operation order (OPORD), sequel, and wargaming.) See FMs 100-5 and 101-5.

breach — A tactical task where any means available are employed to break through or secure a passage through an enemy defense, obstacle, minefield, or fortification. (See also covert breaching, deliberate breaching, and in-stride breach.) See FMs 5-71-100 and 90-13-1. **C-8**

breach force — A combined arms force task-organized with the maneuver and engineer forces necessary to reduce obstacles and create lanes through an obstacle to pass initial assault forces through the lanes. The force is typically equipped with demolitions or mine plows and rollers. When made up primarily of engineers, the force must also be organized with the maneuver forces necessary for local direct fire suppression and security. Breaching forces clear enemy trenches, bunkers, and foxholes, and create and hold open a breach in the enemy positions. During an attack of an enemy fortified position or strongpoint, the breaching forces are those elements charged with breaching obstacles along an avenue of approach. (See also assault force and support force.) See FMs 5-71-100 and 90-13-1.

break-bulk cargo — Cargo which is not shipped in a container. See FM 10-1.

breakout — An operation conducted by an encircled force to regain freedom of movement or contact with friendly units. It differs from other attacks only in that a simultaneous defense in other areas of the

OPERATIONAL TERMS AND GRAPHICS

perimeter must be maintained. (See also encirclement, follow and support, main body, rear guard, and rupture.) See FMs 7-20, 7-30, 71-100, 71-100-2, 71-123, and 100-15.

breakthrough — A rupturing of the enemy's forward defenses that occurs as a result of a penetration. A breakthrough permits the passage of an exploitation force. (See also attack, exploitation, and pursuit.) See FMs 7-20, 7-30, 71-100, 71-100-2, and 71-123.

brevity code (JP 1-02, NATO) — A code which provides no security but which has as its sole purpose the shortening of messages rather than the concealment of their content. See FM 101-5.

bridgehead (JP 1-02) — An area of ground held or to be gained on the enemy's side of an obstacle. (Army) — In river crossing operations, an area on the enemy's side of the water obstacle that is large enough to accommodate the majority of the crossing force, has adequate terrain to permit defense of the crossing sites, provides security of crossing forces from enemy direct fire, and provides a base for continuing the attack. (See also airhead and beachhead.) See FMs 7-20, 7-30, 71-100, 71-100-2, 71-123, and 90-13.

3-19

bridgehead force — A force that assaults across a river to secure the enemy side of a river (the bridgehead) to allow the buildup and passage of a breakout force during river crossing operations. See FMs 7-20, 7-30, 71-100, 71-100-2, 71-123, and 90-13.

bridgehead line (JP 1-02, NATO) — The limit of the objective area in the development of the bridgehead. (See also bridgehead and crossing force.) See FMs 7-20, 7-30, 71-100, 71-100-2, 71-123, and 90-13.

3-19

brigade support area (BSA) (Army) — A designated area in which combat service support elements from division support command and corps support command provide logistic support to a brigade. The forward support battalion (FSB) manages the terrain and unit locations. Examples of units located in the BSA are FSB command post (CP), brigade rear CP, FSB supply company CP, class I, II, IV, and VII points, ammunition transfer point, forward support medical company, class VIII point, medical clearing station, air defense artillery battery (-), and forward signal platoon (-). See FMs 7-30, 8-10-1, and 63-20.

3-39

broadcast intelligence — The dissemination of intelligence and targeting information to multiple terminals at multiple echelons down to brigade level simultaneously to provide a common intelligence picture at all those echelons. This eliminates bottlenecks inherent in point-to-point communications. See FMs 34-1, 71-100, and 100-15.

buffer zone — A defined area controlled by a peace operations force from which disputing or belligerent forces have been excluded. A buffer zone is formed to create an area of separation between disputing or belligerent forces and reduce the risk of renewed conflict. It is also called area of separation in some United Nations operations. (See also zone of separation (ZOS).)

buildup (JP 1-02, NATO) — The process of attaining prescribed strength of units and prescribed levels of vehicles, equipment, stores, and supplies. Also may be applied to the means of accomplishing this process. See FMs 100-15 and 100-17.

built-up area — A concentration of structures, facilities, and population, such as villages, cities, and towns. See FMs 7-8, 7-20, 7-30, 71-100-2, 71-123, 90-10, and 90-10-1.

bulk cargo (JP 1-02) — That which is generally shipped in volume where the transportation conveyance is the only external container; such as liquids, ore, or grain. (Army) — Cargo with dimensions less than oversized cargo and cargo that fits on a 463L aircraft pallet. See FMs 55-10 and 100-10.

bulk petroleum product (JP 1-02, NATO) — A liquid petroleum product transported by various means and stored in tanks or containers having an individual fill capacity greater than 250 liters. See FMs 10-67, 63-2, 63-20, 63-21, and 100-10.

bulk storage (JP 1-02) — **1.** Storage in a warehouse of supplies and equipment in large quantities, usually in original containers, as distinguished from bin storage. **2.** Storage of liquids, such as petroleum products in tanks, as distinguished from drum or packaged storage. (See also bulk cargo and bulk petroleum product.) See FMs 63-2, 63-20, 63-21, and 100-10.

bump plan — In movement, a plan that describes in detail which individuals and equipment in each designated load or chalk has priority over the others. This plan is used when the means of transportation (truck, helicopter, airplane, or ship) cannot carry all of a particular load. (See also chalk.) See FMs 71-100-3 and 90-4.

bypass — A tactical task that involves maneuvering around an obstacle, position, or enemy force to maintain the momentum of advance. Bypassed obstacles and enemy forces are reported to higher headquarters. See FMs 7-20, 7-30, 17-95, 71-100, 71-123, and 100-15. **3-27** **C-8**

bypass criteria — A measure during the conduct of an offensive operation established by higher headquarters that specifies the conditions and size under which enemy units and contact may be avoided. See FMs 7-20, 7-30, 17-95, 71-100, 71-123, and 100-15.

C

call for fire (JP-1-02, NATO) — A request for fire containing data necessary for obtaining the required fire on a target. (See also adjustment of fire.) See FM 6-20 series and FM 7-90.

call forward area — **1.** In river crossing operations, waiting areas within the crossing area where final preparations are made. **2.** In air movement operations, the area at the departure airfield where plane loads are assembled in a ready condition prior to being directed to the loading ramp area. (See also aerial port of embarkation (APOE), airborne, chalk, staging area, and tanker airlift control element (TALCE).) See FMs 55-12 and 90-13.

camouflage (JP 1-02, NATO) — The use of natural or artificial material on personnel, objects, or tactical positions with the aim of confusing, misleading, or evading the enemy. (See also concealment, cover, deception, and surveillance.) See FM 90-2.

campaign (JP 1-02) — A series of related military operations aimed at accomplishing a strategic or operational objective within a given time and space. (See also campaign plan.) See FMs 100-5 and 100-15.

campaign plan (JP 1-02) — A plan for a series of related military operations aimed at accomplishing a strategic or operational objective within a given time and space. (See also campaign.) See FMs 100-5 and 100-15.

canalize (JP 1-02) — To restrict operations to a narrow zone by use of existing or reinforcing obstacles or by fire or bombing. (Army) — A tactical task used to restrict operations to a narrow zone by the use of

OPERATIONAL TERMS AND GRAPHICS

obstacles, fires, or unit maneuvering or positioning. (See also obstacle.) See FMs 5-100 and 5-102. **C-8**

cannibalize (JP 1-02, NATO) — To remove serviceable parts from one item of equipment in order to install them on another item of equipment. (Army) — The authorized removal of parts or components from economically unrepairable or disposable items or assemblies and making them available for reuse. (See also battle damage assessment and repair (BDAR).) See FMs 63-2, 63-2-1, 63-6, 63-20, 63-21, and 71-123. **3-37**

capture — The taking into custody of a hostile force, equipment, or personnel as a result of military operations. See FM 34-1.

captured — See missing.

casualty (JP 1-02) — Any person who is lost to the organization by having been declared dead, duty status-whereabouts unknown, missing, ill, or injured. See FMs 8-10, 8-10-1, 8-10-6, 8-55, 12-6, and 16-1.

casualty collection point (CCP) — A specific location where casualties are assembled to be transported to a medical treatment facility (MTF), for example, a company aid post. See FM 8-55. **3-37**

casualty transport — The movement of casualties by nonmedical transportation assets without the provisions of *en route* medical care.

C-day (JP1-02) — The unnamed day on which a deployment operation commences or is to commence. The deployment may be movement of troops, cargo, weapon systems, or a combination of these elements using any or all types of transport. The letter "C" will be the only one used to denote the above. The highest command or headquarters responsible for coordinating the planning will specify the exact meaning of C-day within the aforementioned definition. The command or headquarters directly responsible for the execution of the operation, if other than the one coordinating the planning, will do so in light of the meaning specified by the highest command or headquarters coordinating the planning. See FMs 100-5, 100-15, and 100-17.

cease engagement (JP 1-02, NATO) — In air defense, a fire control order used to direct units to stop the firing sequence against a designated target. Guided missiles already in flight will continue to intercept. (See also engage and hold fire.) See FM 44-100.

cease fire (JP 1-02) — A command given to air defense artillery units to refrain from firing on, but to continue to track, an airborne object. Missiles already in flight will be permitted to continue to intercept. (Army) — A command given to any unit or individual firing any weapon to stop engaging the target. (See also call for fire, fire command, and fire mission.) See FMs 6-20, 7-8, 7-90, 17-12, 23-1, and 44-100.

cease loading (JP 1-02, NATO) — In artillery and naval gunfire support, the command used during firing of two or more rounds to indicate the suspension of inserting rounds into the weapon. (Army) — Pertains to mortar fire also. See FMs 6-20 series and 7-90.

cell (JP 1-02) — Small group of individuals who work together for clandestine or subversive purposes.

centers of gravity (JP 1-02) — Those characteristics, capabilities, or localities from which a military force derives its freedom of action, physical strength, or will to fight. (Army) — The hub of all power and movement, on which everything depends. (See also operational art and operational level of war.) See FMs 100-5, 100-7, and 100-15.

centigray (cGy) (JP 1-02, NATO) — A unit of absorbed dose of radiation (one centigray equals one rad). (Army) — The term centigray (1/100 of a gray) (one *gray* equals 100 rads) has replaced the term rad and is the equivalent of one rad. (See decontamination.) See FMs 3-3-1 and 3-4.

chaff (JP 1-02) — Radar confusion reflectors, which consist of thin, narrow metallic strips of various lengths and frequency responses, used to reflect echoes for confusion purposes. (Army) — Causes enemy missiles to lock on to it instead of the real aircraft. (See also deception.) See FMs 1-111 and 90-2.

chain of command (JP 1-02, NATO) — The succession of commanding officers from a superior to a subordinate through which command is exercised. Also called command channel.

chalk — Designated troops, equipment, or cargo that constitutes a complete aircraft load. (See also air assault, airborne, and tanker air lift control element (TALCE).) See FMs 71-100-2, 71-100-3, 90-4, and 90-26.

chalk number (JP 1-02, NATO) — The number given to a complete load and to the transporting carrier. (See also chalk.) See FMs 71-100-2, 71-100-3, 90-4, and 90-26.

challenge (JP 1-02, NATO) — Any process carried out by one unit or person with the object of ascertaining the friendly or hostile character or identity of another. (See also password.)

check firing (JP 1-02, NATO) — In artillery and naval gunfire support, a command to cause a temporary halt in firing. (Army) — Pertains to mortar fire also. (See also cease fire, cease loading, and fire mission.) See FM 6-20 series.

checkpoint (CP) (JP 1-02, NATO) — **1.** A predetermined point on the surface of the earth used as a means of controlling movement, a registration target for fire adjustment, or reference for location. **2.** Center of impact; a burst center. **3.** Geographical location on land or water above which the position of an aircraft in flight may be determined by observation or by electrical means. **4.** A place where military police check vehicular or pedestrian traffic in order to enforce circulation control measures and other laws, orders, and regulations. (Army) — **1.** Predetermined point on the ground used to control movement and tactical maneuver. **2.** A place where military police are set up to provide information and prevent illegal actions or actions that aid the enemy; this includes inspection of vehicles and cargo. See FMs 19-1, 19-4, 71-123, and 100-103. **3-25**

chemical agent (JP 1-02, NATO) — A chemical substance which is intended for use in military operations to kill, seriously injure, or incapacitate personnel through its physiological effects. The term excludes riot control agents, herbicides, smoke, and flame. (See also biological agent, chemical defense, and decontamination.) See FMs 3-9 and FM 8-10-7.

chemical defense (JP 1-02, NATO) — The methods, plans, and procedures involved in establishing and executing defensive measures against attack utilizing chemical agents. (See also chemical agent and decontamination.) See FMs 3-3 and 3-100.

chemical downwind message (CDM) — A weather forecast valid for three 2-hour periods (6 hours). The CDM forecasts wind direction, wind speed, air stability, humidity, air temperature, and any significant weather. (See also decontamination and mission-oriented protective posture (MOPP).) See FM 3-3.

chemical warfare (CW) (JP 1-02) — All aspects of military operations involving the employment of lethal and incapacitating munitions/agents and the warning and protective measures associated with such offensive operations. Since riot control agents and herbicides are not considered to be chemical warfare

OPERATIONAL TERMS AND GRAPHICS

agents, those two items will be referred to separately or under the broader term "chemical," which will be used to include all types of chemical munitions/agents collectively. The term "chemical warfare weapons" may be used when it is desired to reflect both lethal and incapacitating munitions/agents of either chemical or biological origin. (See also chemical defense, herbicide, and riot control agent.) See FMs 3-9 and 3-100.

choices of maneuver (Army) — Distinct tactical combinations of fire and movement with a unique set of doctrinal characteristics that differ primarily in the relationship between the maneuvering force and the enemy. The choices of offensive maneuver are envelopment, turning movement, infiltration, penetration, and frontal attack. The choices of defensive maneuver are forward and in-depth. Commanders use these to orient on the enemy, not terrain. More than one may be applied during an operation and may be used in conjunction with a form of tactical operation. (See also attack, envelopment, frontal attack, infiltration, penetration, turning movement, and type of operation.) See FMs 71-100, 100-5, 100-7, and 100-15.

choke point — A geographical location on land or water that restricts the movement of forces and can be natural, man-made, or created through the disposition of forces.

circular error probable (CEP) (JP 1-02) — An indicator of the delivery accuracy of a weapon system, used as a factor in determining probable damage to a target. It is the radius of a circle within which half of a missile's projectiles are expected to fall. (Army) — Error in location of a system or vehicle based on the on-board navigational system and the distance from the last survey control point. See FMs 6-50 series, 7-90, 17-12, and 23-1.

civil administration — An administration established by a foreign government in (1) friendly territory, under an agreement with the government of the area concerned, to exercise certain authority normally the function of the local government (also called civil affairs administration), or (2) hostile territory, occupied by US forces, where a foreign government exercises executive, legislative, and judicial authority until an indigenous civil government can be established. (See also civil affairs (CA), civil military operations (CMO), and stability and support operations (SASO).) See FM 41-10.

civil affairs (CA) (JP 1-02) — The activities of a commander that establish, maintain, influence, or exploit relations between military forces and civil authorities, both governmental and nongovernmental, and the civilian populace in a friendly, neutral, or hostile area of operations in order to facilitate military operations and consolidate operational objectives. Civil affairs may include performance by military forces of activities and functions normally the responsibility of local government. These activities may occur prior to, during, or subsequent to other military actions. They may also occur, if directed, in the absence of other military operations. (Army) — **1.** Matters concerning the relationship between military forces located in a country or area and the civil authorities and people of that country or area, usually occurring in time of hostilities or other emergency, and normally covered by a treaty or other agreement, expressed or implied. **2.** Military government: the form of administration by which occupying power exercises executive, legislative, and judicial authority over occupied territory. See FM 41-10. **4-30**

civil defense emergency — See domestic emergencies.

civil disturbances — See domestic emergencies.

civil-military operations (CMO) (Army) — The complex of activities in support of military operations embracing the interaction between the military force and civilian authorities fostering the development of favorable emotions, attitudes, and behavior in neutral, friendly, or hostile groups. See FM 41-10.

civil-military operations center (CMOC) (Army) — An operations center formed from civil affairs assets that serves as the primary interface between the US armed forces and the local civilian population, humanitarian organizations, nongovernmental organizations, private voluntary organizations, United Nations and other international agencies, multinational military forces, and other agencies of the US government. The primary purpose of the CMOC is to ensure continuous coordination among the key participants in a given area with regards to civil military matters. It is a flexible, mission-dependent organization that can be formed at brigade through joint levels of command. See FM 41-10.

clandestine operation (JP 1-02) — An operation sponsored or conducted by governmental departments or agencies in such a way as to assure secrecy or concealment. A clandestine operation differs from a covert operation in that emphasis is placed on concealment of the operation rather than on concealment of identity of sponsor. In special operations, an activity may be both covert and clandestine and may focus equally on operational considerations and intelligence-related activities.

classes of supply — The grouping of supplies by type into 10 categories to facilitate supply management and planning. **3-39, 3-40** **4-27, 4-28**

Supply Class	Definition/Examples
* I	Subsistence items (meals ready to eat (MRE), T-rations, and fresh fruits and vegetables) and gratuitous-issue health and comfort items. 3-39 4-27
II	Clothing, individual equipment, tentage, organizational tool sets and kits, hand tools, maps, and administrative and housekeeping supplies and equipment. 3-39 4-28
III	Petroleum fuels, lubricants, hydraulic and insulating oils, preservatives, liquids and gases, bulk chemical products, coolants, deicer and antifreeze compounds, components and additives of petroleum and chemical products, and coal. 3-39 4-28
IV	Construction materials including installed equipment, and all fortification and obstacle materials. 3-39 4-28
V	Ammunition of all types including chemical, bombs, explosives, mines, fuzes, detonators, pyrotechnics, missiles, rockets, propellants, and other associated items. 3-39 4-28
* VI	Personal demand items such as health and hygiene products, writing material, snack food, beverages, cigarettes, batteries, and cameras (nonmilitary items). 3-39 4-28
VII	Major end items such as launchers, tanks, mobile machine shops, and vehicles. 3-39 4-28
* VIII	Medical material, including repair parts peculiar to medical equipment and management of blood. 3-40 4-28
IX	Repair parts and components, to include kits, assemblies, and subassemblies (repairable or nonrepairable), that are required for maintenance support of all equipment. 3-40 4-28
X	Material required to support nonmilitary programs, such as agricultural and economic development projects (not included in classes I through IX). 3-40 4-28
MISC	Water, captured enemy material, salvage material. 4-27, 4-29

OPERATIONAL TERMS AND GRAPHICS

clear (JP 1-02) — **1.** To approve or authorize, or to obtain approval or authorization for: **a.** a person or persons with regard to their actions, movements, duties, etc; **b.** an object or group of objects, as equipment or supplies, with regard to quality, quantity, purpose, movement, disposition, etc; and **c.** a request, with regard to correctness of form, validity, etc. **2.** To give one or more aircraft a clearance. **3.** To give a person a security clearance. **4.** To fly over an obstacle without touching it. **5.** To pass a designated point, line, or object. The end of a column must pass the designated feature before the latter is cleared. **6. a.** To operate a gun so as to unload it or make certain no ammunition remains; and **b.** to free a gun of stoppages. **7.** To clear an engine; to open the throttle of an idling engine to free it from carbon. **8.** To clear the air to gain either temporary or permanent air superiority or control in a given sector. (Army) — **1.** A tactical task to remove all enemy forces and eliminate organized resistance in an assigned zone, area, or location by destroying, capturing, or forcing the withdrawal of enemy forces such that they cannot interfere with the friendly unit's ability to accomplish its mission. **2.** To eliminate transmissions on a tactical radio net in order to allow a higher-precedence transmission to occur. **3.** The total elimination or neutralization of an obstacle that is usually performed by follow-on engineers and is not done under fire. (See also reduce.) See FMs 5-100, 5-101, and 90-13-1. **C-8**

clearance of fires — The process of approving or obtaining approval to attack targets with indirect fires within and outside the boundaries of the maneuver unit for which the fires are provided. See FMs 6-20 series, 7-30, 7-90, 71-100, and 71-123.

clearing operation (JP 1-02) — An operation designed to clear or neutralize all mines and obstacles from a route or area. (See also breach.) See FMs 5-100, 5-101, and 90-13-1.

clearing station — An Echelon II medical treatment facility established by a medical company that provides emergency or resuscitative treatment for patients until evacuated and definitive treatment for patients with minor illness, wounds, or injuries who can return to duty.

close air support (CAS) (JP 1-02) — Air action by fixed- and rotary-wing aircraft against hostile targets which are in close proximity to friendly forces and which require detailed integration of each air mission with the fire and movement of those forces. (See also air interdiction (AI).) See FMs 1-111 and 6-20 series.

close operations — Involves forces in immediate contact with the enemy and the fighting between the committed forces and the readily available tactical reserves of both combatants. (See also attack, battlefield organization, and defend.) See FMs 7-7, 7-8, 7-10, 7-20, 7-30, 71-100, 71-123, 100-5, and 100-15.

cluster(JP 1-02, NATO) — **1.** Fireworks signal in which a group of stars burns at the same time. **2.** Group of bombs released together. A cluster usually consists of fragmentation or incendiary bombs. See FM 6-20 series. **3.** Two or more parachutes for dropping light or heavy loads. See FMs 90-26 and 71-100-2. **4.** In land mine warfare, a component of a pattern-laid minefield. It may be antitank, antipersonnel, or mixed. It consists of one to five mines and no more than one antitank mine. See FM 5-102. **5.** Two or more engines coupled together so as to function as one power unit. **6.** In naval mine warfare, a number of mines laid in close proximity to each other as a pattern or coherent unit. They may be of mixed types. **7.** In minehunting, designates a group of mine-like contacts.

clutter (JP 1-02) — Permanent echoes, cloud, or other atmospheric echo on radar scope; as contact has entered scope clutter. (See also air defense) See FM 44-100.

coalition — An *ad hoc* arrangement between two or more nations for common action. (See also alliance and multinational operations.) See FMs 100-5, 100-15, and 100-20.

coil — An arrangement of vehicles forming a circle and providing 360-degree security in an assembly area with the primary weapon systems and protective armor facing outward. See FMs 7-7, 17-12, 17-15, and 17-95.

collateral damage — Unintended and undesirable civilian personnel injuries or materiel damage adjacent to a target produced by the effects of friendly weapons. See FM 6-20 series.

collateral damage distance — Minimum distance in meters that a desired ground zero for a nuclear explosion must be separated from civilian personnel and materiel to ensure with 99-percent assurance that a 5-percent incidence of injuries or property damage will not be exceeded. See FM 100-30.

collateral mission activities — The inherent capabilities of all military forces that may periodically be applied to accomplish missions other than those for which the forces are principally organized, trained, and equipped. Collateral activities in which special operations forces, by virtue of inherent capabilities, may be tasked to participate include humanitarian assistance, security assistance, search and rescue, counternarcotics, antiterrorism and other security activities, and special activities. See FM 31-20.

collecting point (JP 1-02) — A point designated for the assembly of personnel casualties, stragglers, disabled materiel, salvage, etc, for further movement to collecting stations or rear installations. (Army and Marine Corps: collection point.)

collection emphasis message — A unit's collection strategy in a narrative message format. This message communicates the collection intent and "big picture" to higher, lower, and adjacent units; collectors; and others. See FM 34-2.

collection plan (JP 1-02, NATO) — A plan for collecting information from all available sources to meet intelligence requirements and for transforming those requirements into orders and requests to appropriate agencies. (See also combat intelligence, information requirements, reconnaissance (recon, recce), and reconnaissance and surveillance plan.) See FMs 34-1 and 101-5.

collection point — A point designated for the assembly of casualties, stragglers, not operationally ready equipment and materiel, salvage, prisoners, and so on for treatment, classification, sorting, repair, or further movement to collecting stations or rear facilities and installations. (See also aid station.) See FMs 7-10, 7-20, 7-30, 8-10-1, 8-10-6, 63-2, 63-2-1, 63-6, 63-20, 63-21, 71-100, and 71-123.
3-37, 3-38

column formation (Army) — An arrangement of vehicles or dismounted troops in which each individual or vehicle in a specified unit follows directly behind the one in front. This type formation provides good security and permits maximum fire to the flanks, facilitates control, facilitates rapid deployment into any other formation, normally employs flank security, and may employ rear or forward security. It is used when speed is essential or for road marches, night movements, and when passing through defiles or dense woods. (See also box formation, diamond formation, echelon formation, formation, line formation, movement formation, vee formation, and wedge formation.) See FMs 7-7, 7-8, 7-10, 7-20, and 17-95.

combatant command (JP 1-02) — A unified or specified command with a broad continuing mission under a single commander established and so designated by the President, through the Secretary of Defense, and with the advice and assistance of the Chairman of the Joint Chiefs of Staff. Combatant commands typically have geographic or functional responsibilities. See FMs 100-5, 100-15, and JP 0-2.

combatant command (command authority) (COCOM) (JP 0-2, JP 1-02) — Nontransferable command authority established by title 10 ("Armed Forces"), United States Code, section 164, exercised only by

OPERATIONAL TERMS AND GRAPHICS

commanders of unified or specified combatant commands unless otherwise directed by the President or the Secretary of Defense. Combatant command (command authority) cannot be delegated and is the authority of a combatant commander to perform those functions of command over assigned forces involving organizing and employing commands and forces, assigning tasks, designating objectives, and giving authoritative direction over all aspects of military operations, joint training, and logistics necessary to accomplish the missions assigned to the command. Combatant command (Command authority) should be exercised through the commanders of subordinate organizations. Normally this authority is exercised through subordinate joint force commanders and Service and/or functional component commanders. Combatant command (command authority) provides full authority to organize and employ commands and forces as the combatant commander considers necessary to accomplish assigned missions.

Operational control is inherent in combatant command (command authority). (See also combatant command, operational control (OPCON), and tactical control (TACON).) See Fms 100-5, 100-15, and JP 0-2.

combat arms — Units and soldiers who close with and destroy enemy forces or provide firepower and destructive capabilities on the battlefield. The included branches and functions are: Air Defense Artillery, Armor/Cavalry, Aviation, Field Artillery, Infantry, Special Forces, and the Corps of Engineers.
4-10 to 4-18

combat assessment (JP 1-02) — The determination of the overall effectiveness of force employment during military operations. Combat assessment is composed of three major components: (a) battle damage assessment, (b) munitions effects assessment, and (c) reattack recommendation. The objective of combat assessment is to identify recommendations for the course of military operations. The J-3 is normally the single point of contact for combat assessment at the joint force level, assisted by the joint force J-2. (See also battle damage assessment (BDA), course of action (COA), and wargaming.) See FM 101-5.

combat configured load (CCL) (Army) — A planned package of ammunition or other supplies that are transported as a single load to support a type unit or weapon system. See FM 9-6.

combat control team (CCT) (Army) — A team of Air Force personnel organized, trained, and equipped to establish and operate navigational or terminal guidance aids, communications, and aircraft control facilities within the objective area of an airborne operation. (See also airborne and landing zone (LZ).) See FMs 7-20, 7-30, 71-100-2, and 90-26.

combat effectiveness — The ability of a unit to perform its mission. Factors such as ammunition, personnel, status of fuel, and weapon systems are assessed and rated. See FM 101-5.

combat functions — Functions that commanders integrate and coordinate to synchronize battle effects in time, space, and purpose. They are intelligence, maneuver, fire support, air defense, mobility and survivability, logistics, and battle command. See FM 100-5.

combat health support — All services performed, provided, or arranged to promote, improve, conserve, or restore the mental or physical well-being of personnel in the Army and, as directed, for other services, agencies, and organizations. See FM 8-10-1.

combat information (JP 1-02) — Unevaluated data, gathered by or provided directly to the tactical commander which, due to its highly perishable nature or the criticality of the situation, cannot be processed into tactical intelligence in time to satisfy the user's tactical intelligence requirements. (See also information requirements (IR).)

combat intelligence (JP 1-02) — That knowledge of the enemy, weather, and geographical features required by a commander in the planning and conduct of combat operations. (Army) — Information on the enemy's capabilities, intentions, vulnerabilities, and the environment. (See also collection plan, intelligence preparation of the battlefield (IPB), reconnaissance (recon, recce), and reconnaissance and surveillance plan.) See FMs 1-111, 5-100, 7-20, 7-30, 17-95, 31-20, 34-1, 34-2, 71-100, 71-123, 100-5, 100-15, 100-20, 100-25, and 101-5.

combat load — Those quantities of all classes of supplies kept by a unit to sustain operation in combat for a prescribed number of days. Combat loads must be capable of being moved into combat in one lift using organic transportation. See FM 10-1.

combat loading (JP 1-02, NATO) — The arrangement of personnel and the stowage of equipment and supplies in a manner designed to conform to the anticipated tactical operation of the organization embarked. Each individual item is stowed so that it can be unloaded at the required time. (See also load plan.) See FMs 7-8, 55-12, and 71-10.

combat multiplier — Supporting and subsidiary means that significantly increase the relative combat strength (power) of a force while actual force ratios remain constant. Examples of combat multipliers are economizing in one area to mass in another, leadership, unit morale, surprise, deception, battlefield information, camouflage, electronic warfare, psychological operations, terrain reinforcement, smoke, and indirect fires. (See also combat power.) See FM 100-5.

combat observation and lasing team (COLT) — A fire support team controlled at the brigade level that is capable of target acquisition under reduced visibility conditions and has both laser-rangefinding and laser-designating capabilities. (See also call for fire.) See FMs 6-20-10, 7-30, and 17-95. **4-15**

combat outpost — A well-prepared fortified outpost used to engage enemy reconnaissance and main body forces. Combat outposts are normally employed in restrictive terrain where armored forces cannot adequately deploy or when the security force is less mobile than the enemy and can be employed during security operations such as a guard or cover. Combat outposts may accept encirclement or displace, based on commander's intent. (See also counterreconnaissance.) See FMs 7-30, 71-100, and 100-40. **4-9** **4-17**

combat patrol (NATO) — For ground forces, a tactical unit sent out from the main body to engage in independent fighting; detachment assigned to protect the front, flank, or rear of the main body by fighting if necessary. Also called fighting patrol. (See also ambush, raid, and security operations.) See FMs 7-7, 7-8, 7-10, and 71-123.

combat power (JP 1-02, NATO) — The total means of destructive and/or disruptive force which a military unit/formation can apply against the opponent at a given time. (Army) — A combination of the effects of maneuver, firepower, protection, and leadership. (See also combat multiplier.) See FMs 1-111, 7-20, 7-30, 17-95, 71-100, and 71-123, and 100-5.

combat service support (CSS) (JP 1-02) — The essential capabilities, functions, activities, and tasks necessary to sustain all elements of operating forces in theater at all levels of war. Within the national and theater logistic systems, it includes but is not limited to that support rendered by service forces in ensuring the aspects of supply, maintenance, transportation, health services, and other services required by aviation and ground combat troops to permit those units to accomplish their missions in combat. Combat service support encompasses those activities at all levels of war that produce sustainment to all operating forces on the battlefield. (Army) — CSS also include those activities in stability and support operations that sustain all operating forces. The included branches and functions are: Adjutant General

OPERATIONAL TERMS AND GRAPHICS

Corps, Acquisition Corps, Chaplain Corps, Finance Corps, Judge Advocate General Corps, Medical Corps, Ordnance Corps, Transportation Corps, and the Quartermaster Corps. See FMs 8-10, 10-1, 100-5, and 100-10. **4-23 to 4-29**

combat service support element (CSSE) (USMC) — The Marine air-ground task force (MAGTF) element that is task-organized to provide the full range of combat service support necessary to accomplish the MAGTF mission. The CSSE can provide supply, maintenance, transportation, deliberate engineering, health, postal, disbursing, prisoner of war, information systems, exchange, utilities, legal, and graves registration services. The CSSE varies in size from a Marine expeditionary unit (MEU) service support group (MSSG) to a force service support group (FSSG). Normally, there is only one combat service support element in a MAGTF.

combat stress control (CSC) — A coordinated program for the prevention, triage, and treatment of each echelon of battle fatigue to maximize rapid return to duty and minimize misconduct stress reactions and post-traumatic stress disorders. This program is conducted by unit mental health personnel plus echelon above division combat stress control units. See FMs 8-51 and 22-51.

combat support (CS) — Units and soldiers that provide critical combat functions in conjunction with combat arms units and soldiers to secure victory. The included branches and functions are: Chemical Corps, civil affairs, psychological operations, Military Intelligence, Military Police Corps, and the Signal Corps. **4-19 to 4-23**

combat support elements (JP 1-02) — Those elements whose primary missions are to provide combat support to the combat forces and which are a part, or prepared to become a part, of a theater, command, or task force formed for combat operations.

combatting terrorism (JP 1-02) — Actions, including antiterrorism (defensive measures taken to reduce vulnerability to terrorist acts) and counterterrorism (offensive measures taken to prevent, deter, and respond to terrorism), taken to oppose terrorism throughout the entire threat spectrum. (See also stability and support operations (SASO).) See FM 100-20.

combat trains — The portion of unit trains that provides the combat service support required for immediate response to the needs of forward tactical elements. At company level, medical recovery, supply, and maintenance elements normally constitute the combat trains. At battalion, the combat trains normally consist of ammunition and petroleum, oils, and lubricants (POL) vehicles, maintenance and recovery vehicles and crews, and the battalion aid station. (See also collection point, field trains, and unit trains.) See FMs 7-10, 7-20, 7-30, and 71-123.

combat trains command post (CTCP) — The CTCP consists of the Task Force S4 and representatives from the S1. It plans and coordinates sustainment for tactical operations and serves as the alternate for the main CP. (See also alternate command post, brigade support area, collection point, combat trains, field trains, and unit trains.) See FM 7-10, 7-20, and 71-123. **A-3**

combat zone (CZ) (JP 1-02) — **1.** That area required by combat forces for the conduct of operations. **2.** The territory forward of the Army rear area boundary. (NATO) — It is divided into: **a.** the forward combat zone, comprising the territory forward of the corps rear boundary; and **b.** the rear combat zone, usually comprising the territory between the corps rear boundary and the army group rear boundary. (See also communications zone (COMMZ).) See FMs 100-5 and 100-7.

combined arms — The synchronized or simultaneous application of several arms, such as infantry, armor, artillery, engineers, air defense, and aviation, to achieve an effect on the enemy that is greater than if each

arm was used against the enemy in sequence. (See also combat multiplier and task force (TF).) See FMs 71-100, 71-123, and 100-5.

combined arms team — Two or more arms mutually supporting one another, usually consisting of infantry, armor, cavalry, aviation, field artillery, air defense artillery, and engineers. (See also combat multiplier, joint operations, and task force (TF).) See FMs 71-100, 71-123, and 100-5.

combined operation — *See* combined warfare.

combined warfare (JP 1-02) — Warfare conducted by forces of two or more allied nations in coordinated action toward common objectives. (Army) — Currently referred to as multinational warfare. (See also coalition and multinational operations.) See FM 100-5.

command (JP 1-02) — **1.** The authority that a commander in the Military Service lawfully exercises over subordinates by virtue of rank or assignment. Command includes the authority and responsibility for effectively using available resources and for planning the employment of, organizing, directing, coordinating, and controlling military forces for the accomplishment of assigned missions. It also includes responsibility for health, welfare, morale, and discipline of assigned personnel. **2.** An order given by a commander; that is, the will of the commander expressed for the purpose of bringing about a particular action. **3.** A unit or units, an organization, or an area under the command of one individual. **4.** To dominate by a field of weapon fire or by observation from a superior position. (See also battle command and commander.) See FMs 22-100, 22-103, 100-5, and 101-5.

command and control (C²) (JP 1-02) — The exercise of authority and direction by a properly designated commander over assigned and attached forces in the accomplishment of the mission. Command and control functions are performed through an arrangement of personnel, equipment, communications, facilities, and procedures employed by a commander in planning, directing, coordinating, and controlling forces and operations in the accomplishment of the mission. (See also battle command, command, commander, and command post (CP).) See FMs 7-20, 7-30, 71-100, 71-123, 100-15, and 101-5.

command, control, communications, computers, and intelligence (C⁴I) — Integrated system of doctrine, procedures, organizational structures, facilities, communication computers, and supporting intelligence assets. It includes missile warning and cueing of defense systems by missile warning sensors and ground stations. C⁴I provides command authorities at all levels with timely and accurate data systems to plan, monitor, direct, control, and report operations. (Army) — The means for the commander to communicate his intent, command and control his forces, and disseminate pertinent information throughout his area of operations.

command and control warfare (C²W) (JP 1-02) — The integrated use of operations security (OPSEC), military deception, psychological operations (PSYOP), electronic warfare (EW), and physical destruction, mutually supported by intelligence, to deny information to, influence, degrade, or destroy adversary command and control capabilities, while protecting friendly command and control capabilities against such actions. Command and control warfare is an application of information warfare in military operations and is a subset of information warfare. Command and control warfare applies across the range of military operations and all levels of conflict. C²W is both offensive and defensive: **a. C²-attack.** Prevent effective C² of adversary forces by denying information to, influencing, degrading or destroying the adversary C² system. **b. C²-protect.** Maintain effective command and control of own forces by turning to friendly advantage or negating adversary efforts to deny information to, influence, degrade, or destroy the friendly C² system. (See also information warfare (IW).) See FMs 34-1, 71-100, 100-5, 100-15, and JP 3-13.1.

OPERATIONAL TERMS AND GRAPHICS

command element (CE) (JP 1-02) — The Marine air-ground task force (MAGTF) headquarters. The CE is a permanent organization composed of the commander, general or executive and special staff sections, headquarters section, and requisite communications and service support facilities. The CE provides command, control, and coordination essential for effective planning and execution of operations by the other three elements of the MAGTF. There is only one CE in a MAGTF.

commander — One who is in command because of rank, position, or other circumstances. (See also battle command and command.)

commander's critical information requirements (CCIR) — Information required by the commander that directly affects his decisions and dictates the successful execution of operational or tactical operations. CCIR normally result in the generation of three types of information requirements: priority intelligence requirements, essential elements of friendly information, and friendly force information requirements. (See also essential elements of friendly information (EEFI), friendly force information requirements (FFIR), and priority intelligence requirements (PIR).) See FMs 34-1, 71-100, 100-15, and 101-5.

commander's estimate of the situation (JP 1-02) — A logical process of reasoning by which a commander considers all the circumstances affecting the military situation and arrives at a decision as to a course of action to be taken to accomplish the mission. A commander's estimate which considers a military situation so far in the future as to require major assumptions is called a commander's long-range estimate of the situation. (Army) — The procedure whereby a commander decides how to best accomplish the assigned mission. It is a thorough consideration of the mission, enemy, terrain, troops, and time available (METT-T) and other relevant factors. The commander's estimate is based on personal knowledge of the situation and on staff estimates. (See also battle command, battlespace, and staff estimates.) See FM 101-5.

commander's intent (Army) — A clear, concise statement of what the force must do to succeed with respect to the enemy and the terrain and to the desired end state. It provides the link between the mission and the concept of operations by stating the key tasks that, along with the mission, are the basis for subordinates to exercise initiative when unanticipated opportunities arise or when the original concept of operations no longer applies. If the commander wishes to explain a broader purpose beyond that of the mission statement, he may do so. Intent is normally expressed in four or five sentences and is mandatory for all orders. The mission and the commander's intent must be understood two echelons down. See FM 101-5.

command group — A small party that accompanies the commander when he departs the command post to be present at a critical action. The party is organized and equipped to suit the commander and normally provides local security and other personal assistance for the commander as he requires. (See also command post (CP).) See FMs 7-20, 7-30, 17-95, 71-100, 71-123, 100-5, and 101-5. **A-2**

command post (CP) (JP 1-02, NATO) — A unit's or subunit's headquarters where the commander and the staff perform their activities. In combat, a unit's or subunit's headquarters is often divided into echelons; the echelon in which the unit or subunit commander is located or from which such commander operates is called a command post. (Army) — The principal facility employed by the commander to control combat operations. (The commander is only present at the command post to receive information or briefings. He controls the battle from a forward position called the command group.) A CP consists of those coordinating and special staff activities and representatives from supporting Army elements and other services that may be necessary to carry out operations. Corps and division headquarters are particularly adaptable to organization by echelon into a tactical CP, a main CP, and a rear CP. (See also alternate command post, assault command post, base defense operations center (BDOC), combat trains command post (CTCP), command group, main command post, rear command post, tactical command post (TAC CP), and tactical operations center (TOC).) See FMs 1-111, 7-20, 7-30, 17-95, 71-100, 71-123, 100-5, and 101-5. **A-3**

- command post exercise (CPX)** (JP 1-02, NATO) — An exercise in which the forces are simulated, involving the commander, his staff, and communications within and between headquarters. (See also exercise.) See FMs 100-5 and 101-5.
- command relationship** (Army) — The degree of control and responsibility a commander has for forces operating under his command. (See also administrative control, assign, attach, direct support (DS), general support (GS), operational control (OPCON), and tactical control (TACON)) See FMs 71-100, 100-5, and 100-15.
- committed force** (Army) — A force in contact with an enemy or deployed on a specific mission or course of action which precludes its employment elsewhere. (See also attack, decisive engagement, and defend.) See FMs 7-7, 7-8 and 7-10.
- common servicing** (JP 1-02) — That function performed by one Military Service in support of another Military Service for which reimbursement is not required from the Service receiving support. (See also command relationship and support.) See FM 10-1.
- common understanding of the battlefield** (Army) — The commander and staff's perception of the battlefield environment. It includes the sum of all that is known or perceived of friendly or threat forces and the effects of the battlefield environment.
- common use** (JP 1-02) — Services, materials, or facilities provided by a Department of Defense agency or a Military Department on a common basis for two or more DOD agencies. See FM 10-1.
- communication deception** (JP 1-02) — Use of devices, operations, and techniques with the intent of confusing or misleading the user of a communications link or a navigation system. (See also command and control warfare (C²W), deception operation, electronic warfare (EW), imitative electromagnetic deception (IED), and information warfare (IW).) See FMs 34-1, 34-10, and 90-2.
- communications checkpoint (CCP)** (Army) — An air control point that requires serial leaders to report either to the aviation mission commander or the terminal control facility. (See also air control point (ACP), air corridor, and Army airspace command and control (A²C²).) See FMs 1-111, 1-112, 1-116, 71-100-3, and 90-4. **3-5**
- communications intelligence (COMINT)** (JP 1-02) — Technical and intelligence information derived from foreign communications by other than the intended recipients. (See also combat intelligence.) See FMs 34-1 and 34-10.
- communications jamming** — Electronic measures taken to deny the enemy the use of communications means. (See also barrage jamming, command and control warfare (C²W), electronic warfare (EW), and jamming.) See FMs 34-1 and 34-10.
- communications security (COMSEC)** (JP 1-02) — The protection resulting from all measures designed to deny unauthorized persons information of value which might be derived from the possession and study of telecommunications, or to mislead unauthorized persons in their interpretation of the results of such possession and study. COMSEC includes cryptosecurity, transmission security, emission security, and physical security of COMSEC materials and information. See FMs 24-1, 34-1, and 34-10.
- communications zone (COMMZ)** (JP 1-02, NATO) — Rear part of theater of operations (behind but contiguous to the combat zone) which contains the lines of communications, establishments for supply and evacuation, and other agencies required for the immediate support and maintenance of the field forces. (See also combat zone (CZ) and rear area.) See FM 100-7.

OPERATIONAL TERMS AND GRAPHICS

- company team** (Army) — A combined arms team formed by attaching one or more nonorganic tank, mechanized infantry, or light infantry platoons to a tank, mechanized infantry, or light infantry company either in exchange for or in addition to organic platoons. (See also combined arms team.) See FM 7-10.
- compartment** — Areas bounded on at least two sides by terrain features affected by drainage and relief, such as woods, ridges, or ravines, that limit observation or observed fire into the area from points outside the area and effect avenues of approach. (See also cross-corridor.) See FMs 7-7, 7-8, 7-10, and 34-130.
- compartmentation** (Army) — In unconventional warfare, the division of an organization or activity into functional segments or cells to restrict communication between them and prevent knowledge of the identity or activities of other segments except on a need-to-know basis. Restricting the use of specific cryptovariabls to specific users for the purpose of limiting access to the information protected by these cryptovariabls and limiting the adverse impact of a compromise of these variables.
- complete round** (JP 1-02) — A term applied to an assemblage of explosive and nonexplosive components designed to perform a specific function at the time and under the conditions desired. Examples of complete rounds of ammunition are: **a.** separate loading, consisting of a primer, propelling charge, and, except for blank ammunition, a projectile and a fuze. **b.** fixed or semifixed, consisting of a primer, propelling charge, cartridge case, a projectile, and, except when solid projectiles are used, a fuze. **c.** bomb, consisting of all component parts required to drop and function the bomb once. **d.** missile, consisting of a complete warhead section and a missile body with its associated components and propellants. **e.** rocket, consisting of all components necessary to function. See FM 6-20 series.
- computed air release point (CARP)** (JP 1-02, NATO) — A computed air position where the first paratroop or cargo item is released to land on a specified impact point. See FMs 71-100-3 and 90-26.
- concealment** (JP 1-02, NATO) — The protection from observation or surveillance. (See also camouflage and cover.) See FMs 7-7, 7-8, 7-10, and 34-130.
- concentrated fire** — A limited area on which a volume of gunfire is placed within a limited time.
- concept of operations** — **1.** (JP 1-02) A verbal or graphic statement, in broad outline, of a commander's assumptions or intent in regard to an operation or series of operations. The concept of operations frequently is embodied in campaign plans and operation plans; in the latter case, particularly when the plans cover a series of connected operations to be carried out simultaneously or in succession. The concept is designed to give an overall picture of the operation. It is included primarily for additional clarity of purpose. **2.** (NATO) A clear and concise statement of the line of action chosen by a commander in order to accomplish his mission. (Army) — Describes how the commander sees the actions of each of his units fitting together to accomplish the mission. As a minimum, the description includes the scheme of maneuver and concept of fires. See FM 100-5.
- concept plan (CONPLAN)** (JP 1-02) — An operation plan in concept format. (See also operation plan (OPLAN).) See FMs 71-100, 100-5, 100-15, and 101-5.
- confirmation brief** — A briefing subordinate leaders give to the higher commander immediately after the operation order is given. It is their understanding of his intent, their specific tasks, and the relationship between their mission and the other units in the operation. (See also backbrief.) See FM 101-5.
- conflict** (Army) — A political-military situation between peace and war, distinguished from peace by the introduction of organized political violence and from war by its reliance on political methods. It shares many of the goals and characteristics of war, including the destruction of governments and the control of territory. See FM 100-20.

conflict termination (Army) — The point a conflict ends and postconflict activities begin. The enemy should be both unable and unwilling to resist. Strategic, operational, and political goals established at the beginning of the conflict should either be secured, or their securement be the immediate result of the end of the conflict. See FM 100-5.

connectivity — The exchange of information by electronic means.

consolidation of position (JP 1-02, NATO) — Organizing and strengthening of a newly captured position so that it can be used against the enemy. (Army) — Also called consolidation phase. (See also assault, attack, and objective.) See FMs 5-102, 7-7, 7-8, 7-10, 7-20, 7-30, and 71-123.

constraint (Army) — Restrictions placed on the command by a higher command to dictate an action or inaction, thus restricting the freedom of action the subordinate commander has for planning a mission by stating things that must or must not be done. See FMs 71-100, 100-15, and 101-5.

consumption rate (JP 1-02, NATO) — The average quantity of an item consumed or expended during a given time interval, expressed in quantities by the most appropriate unit of measurement per applicable stated basis. See FMs 10-1, 63-20, 63-21, and 100-10.

contact (JP 1-02) — **1.** In air intercept, a term meaning, "Unit has an unevaluated target." **2.** In health services, an unevaluated individual who is known to have been sufficiently near an infected individual to have been exposed to the transfer of infectious material. (Army) — **1.** Friendly, when two or more friendly forces make visual, physical, or communications interaction. **2.** Enemy, when a friendly force engages an enemy force physically in hand-to-hand fighting or at the maximum range of weapons and visual or electronic devices. (See also close operations.)

contact point (JP 1-02, NATO) — **1.** In land warfare, a point on the terrain, easily identifiable, where two or more units are required to make contact. **2.** In air operations, the position at which a mission leader makes radio contact with an air control agency. (See also checkpoint (CP), control point, and coordinating point.) See FMs 7-7, 7-8, 7-10, 7-20, 7-30, 19-1, and 71-123. **3-25**

contain (JP 1-02, NATO) — To stop, hold, or surround the forces of the enemy or to cause the enemy to center activity on a given front and to prevent his withdrawing any part of his forces for use elsewhere. (Army) — A tactical task to restrict enemy movement. (See also block, fix, suppression.) See FMs 7-7, 7-8, 7-10, 7-20, 7-30, 71-100, 71-123, and 100-15. **C-8**

container delivery system (CDS) — A system for aerial delivery of supplies and small items of equipment from low or high altitudes into a small area. (See also bulk cargo.) See FM 55-12.

contamination (JP 1-02) — **1.** The deposit, absorption, or adsorption of radioactive material, or of biological or chemical agents on or by structures, areas, personnel, or objects. **2.** Food and/or water made unfit for consumption by humans or animals because of the presence of environmental chemicals, radioactive elements, bacteria or organisms, the byproduct of the growth of bacteria or organisms, the decomposing material (to include the food substance itself), or waste in the food or water. (See also decontamination.) See FMs 3-3, 3-4, 3-5, 3-7, 8-10-7, and 21-10.

contingency (JP 1-02) — An emergency involving military forces caused by natural disasters, terrorists, subversives, or by required military operations. Due to the uncertainty of the situation, contingencies require plans, rapid response, and special procedures to ensure the safety and readiness of personnel, installations, and equipment. (See also branch, concept plan (CONPLAN), operation order (OPORD), operation plan (OPLAN), and sequel.) See FMs 19-15, 71-100, 100-5, 100-15, 100-20, and 101-5.

OPERATIONAL TERMS AND GRAPHICS

contingency plan (Army) — A plan used in accomplishing different missions and anticipated major events before, during, and after operations.

contour flight — Flight characterized by constant airspeed and varying altitude as dictated by vegetation, obstacles, and ambient light. (See terrain flight.) See FMs 1-111, 1-112, and 1-116.

control (JP 1-02) — **1.** Authority which may be less than full command exercised by a commander over part of the activities of subordinate or other organizations. **2.** In mapping, charting, and photogrammetry, a collective term for a system of marks or objects on the Earth or on a map or a photograph, whose positions or elevations, or both, have been or will be determined. **3.** Physical or psychological pressures exerted with the intent to assure that an agent or group will respond as directed. **4.** An indicator governing the distribution and use of documents, information, or material. Such indicators are the subject of intelligence community agreement and are specifically defined in appropriate regulations. (Army) — To maintain physical influence by occupation or range of weapon systems over the activities or access in a defined area. Actions taken to eliminate hazards or reduce their risk (third step in risk management process). (See also administrative control, command relationship, operational control (OPCON), and tactical control (TACON).) See FMs 22-100, 22-103, 71-100, 100-5, 100-15, and 101-5.

controlled airspace (JP 1-02, NATO) — An airspace of defined dimensions within which air traffic control service is provided to controlled flights. (Army) — Airspace in which another unit is conducting operations and which requires permission from controlling unit to enter. (See also airspace coordination area (ACA), area of operations (AO), Army airspace command and control (A²C²), and restricted operations zone (ROZ).) See FM 100-103.

controlled exchange (Army) — The removal of serviceable parts, components, or assemblies from unserviceable, economically repairable equipment and their immediate reuse in restoring a like item of equipment to a combat operable or serviceable condition. (See also cannibalize.) See FMs 10-1, 63-2-1, 63-20, 63-21, and 100-10.

controlled supply rate (CSR) (Army) — The rate of ammunition consumption that can be supported, considering availability, facilities, and transportation. It is expressed in rounds per unit, individual, or vehicle per day. The Army service component commander announces the CSR for each item of ammunition, and, in turn, the commander of each subordinate tactical unit announces a CSR to his commanders at the next lower levels. A unit may not draw ammunition in excess of its CSR without authority from its next higher headquarters. (See also required supply rate (RSR).) See FMs 10-1, 63-20, 63-21, 71-100, 100-10, 100-15, and 701-58.

control measures — Directives given graphically or orally by a commander to subordinate commands to assign responsibilities, coordinate fires and maneuver, and control combat operations. Each control measure can be portrayed graphically. In general, all control measures should be easily identifiable on the ground. Examples of control measures include boundaries, objectives, coordinating points, contact point, and direction of attack. See FMs 5-100, 6-20, 7-90, 71-100, 100-5, 100-15, 100-103-1, 100-103-2, and 101-5.

control point (JP 1-02, NATO) — **1.** A position along a route of march at which men are stationed to give information and instructions for the regulation of supply or traffic. **2.** A position marked by a buoy, boat, aircraft, electronic device, conspicuous terrain feature, or other identifiable object which is given a name or number and used as an aid to navigation or control of ships, boats, or aircraft. **3.** In making mosaics, a point located by ground survey with which a corresponding point on a photograph is matched as a check. See FMs 5-36, 5-100, 7-92, 21-18, 71-100, and 100-15.

controls — Actions taken to eliminate hazards or reduce their risk.

converged sheaf (JP 1-02) — The lateral distribution of fire of two or more pieces so that the planes of fire intersect at a given point. (See also final protective fire (FPF) and sheaf.) See FM 6-20 series and 7-90.

convoy (JP 1-02, NATO) — **1.** A number of merchant ships or naval auxiliaries, or both, usually escorted by warships and/or aircraft, or a single merchant ship or naval auxiliary under surface escort, assembled and organized for the purpose of passage together. **2.** A group of vehicles organized for the purpose of control and orderly movement with or without escort protection. (Army) — A group of vehicles that moves over the same route at the same time and under one commander. (See also march column.) See FMs 55-2, 55-10, and 55-30. **3-37**

coordinated fire line (CFL) (NATO: no-fire line) — A line beyond which conventional surface fire support means (mortars, field artillery, naval gunfire ships) may fire at any time within the zone of the establishing headquarters without additional coordination. It is usually established by brigade or division but may be established by a maneuver battalion. See FMs 6-series and 7-90. **3-21**

coordinating altitude (JP 1-02) — A procedural airspace control method to separate fixed- and rotary-wing aircraft by determining an altitude below which fixed-wing aircraft will normally not fly and above which rotary-wing aircraft normally will not fly. The coordinating altitude is normally specified in the airspace control plan and may include a buffer zone for small altitude deviations. (See also above ground level (AGL) and controlled airspace.) See FMs 1-111, 1-112, 1-116, 6-20, 100-103-1, and 100-103-2,.

coordinating point (JP 1-02, NATO) — Designated point at which, in all types of combat, adjacent units/formations must make contact for purposes of control and coordination. (Army) — A control measure that indicates a specific location for the coordination of fires and maneuver between adjacent units. They usually are indicated whenever a boundary crosses the forward edge of the battle area (FEBA) and may be indicated when a boundary crosses phase lines (PLs) used to control security forces. (In NATO, physical contact between adjacent units is required.) (See also contact point.) See FMs 6-20, 7-20, 7-30, 17-95, 71-100, 71-123, 100-15, 100-103, and 101-5. **3-25**

coordination (Army) — Exchange of information to inform and integrate, synchronize, and deconflict operations. Coordination is not necessarily a process of gaining approval but is most often used for mutual exchange of information.

corduroy road — A road made or reinforced by laying logs or planks perpendicular to the direction of travel. It is usually used when a road is muddy, snow packed, or in a swamp.

counter air (JP 1-02) — A US Air Force term for air operations conducted to attain and maintain a desired degree of air superiority by the destruction or neutralization of enemy forces. Both air offensive and air defensive actions are involved. The former range throughout enemy territory and are generally conducted at the initiative of the friendly forces. The latter are conducted near or over friendly territory and are generally reactive to the initiative of the enemy air forces. (See also defensive counterair (DCA) and offensive counterair (OCA).) See FMs 1-111, 1-112, 1-116, 44-100, 71-100, 90-4, 100-5, 100-15, and 100-103.

counterattack (JP 1-02, NATO) — Attack by part or all of a defending force against an enemy attacking force, for such specific purposes as regaining ground lost, or cutting off or destroying enemy advance units, and with the general objective of denying to the enemy the attainment of his purpose in attacking. In sustained defensive operations, it is undertaken to restore the battle position and is directed at limited objectives. (Army) — An attack with a reserve or lightly committed forward element that is launched after the enemy begins its attack, after the commander has identified the enemy's effort, or when a

OPERATIONAL TERMS AND GRAPHICS

resolute defense creates an assailable flank. (See also attack and defend.) See FMs 1-112, 7-8, 7-30, 17-95, 71-100, 71-123, 100-5, and 100-15. **C-9**

counterdrug (CD) (JP 1-02) — Those active measures taken to detect, monitor, and counter the production, trafficking, and use of illegal drugs. See FMs 100-19 and 100-20.

counterfire (JP1-02, NATO) — Fire intended to destroy or neutralize enemy weapons. (DOD) Includes counterbattery, counterbombardment, and countermortar fire. (Army) — Fires targeted throughout the battlefield that are intended to attack the total enemy fire support system. (Fires include mortars; helicopter forward operating bases; vector target designation points; fire support commands and control; artillery, rocket, and missile systems; and support and sustainment installations.) Two types of counterfire are proactive and reactive fires. (See also fire mission.) See FMs 6-20 series and 7-90.

counterinsurgency (JP 1-02) — Those military, paramilitary, political, economic, psychological, and civic actions taken by a government to defeat insurgency. (See also stability and support operations.) See FMs 31-20 and 100-20.

counterintelligence (CI) (JP 1-02) — Information gathered and activities conducted to protect against espionage, other intelligence activities, sabotage, or assassinations conducted by or on behalf of foreign governments or elements thereof, foreign organizations, or foreign persons, or international terrorist activities. (See also combat intelligence, operations security (OPSEC), and sabotage.) See FM 34-1.

countermeasures (Army) — Actions taken to counter danger, threat, or hazards. (See also risk management.)

countermine (JP 1-02, NATO) — To explode the main charge in a mine by the shock of a nearby explosion of another mine or independent explosive charge. The explosion of the main charge may be caused either by sympathetic detonation or through the explosive train and/or firing mechanism of the mine. (Army) — The actions taken to detect, bypass, breach, mark, report, record, and eliminate enemy mines or minefield. (See also breach.) See FMs 5-101, 5-250, and 90-13-1.

countermobility operations — The construction of obstacles and emplacement of minefields to delay, disrupt, and destroy the enemy by reinforcement of the terrain. The primary purpose of countermobility operations is to slow or divert the enemy, to increase time for target acquisition, and to increase weapon effectiveness. See FMs 3-50, 3-100, 5-102, and 5-250.

counterpreparation fire (JP 1-02, NATO) — Intensive prearranged fire delivered when the imminence of the enemy attack is discovered. (DOD) It is designed to break up enemy formations; disorganize the enemy's systems of command, communications, and observation; decrease the effectiveness of artillery preparation; and impair the enemy's offensive spirit. (See also fire.) See FMs 6-20 series and 7-90.

counterproliferation — Military measures centering on deterring or discouraging, as well as defending against, the possible use of weapons of mass destruction.

counterreconnaissance (JP 1-02) — All measures taken to prevent hostile observation of a force, area, or place. See FMs 1-111, 6-20, 7-10, 7-20, 7-30, 17-95, 34-2, 34-130, 71-100, 71-123, 100-15, 100-40, and 101-5.

counterterrorism (CT) (JP 1-02) — Offensive measures taken to prevent, deter, and respond to terrorism. See FMs 19-1, 34-1, and 100-20.

country team (JP 1-02) — The senior in-country United States coordinating and supervising body, headed by the chief of the United States diplomatic mission, and composed of the senior member of each

represented United States department or agency, as desired by the chief of the US diplomatic mission. See FMs 31-20-3, 100-20, and JP 3-07.4.

coup de main (JP 1-02) — An offensive operation that capitalizes on surprise and simultaneous execution of supporting operations to achieve success in one swift stroke. (Army) — Achieving the strategic objective in a single major operation. See FMs 71-100, 100-5, and 100-15.

course of action (COA) (JP 1-02) — **1.** A plan that would accomplish, or is related to, the accomplishment of a mission. **2.** The scheme adopted to accomplish a task or mission. It is a product of the Joint Operation Planning and Execution System concept development phase. The supported commander will include a recommended course of action in the commander's estimate. The recommended course of action will include the concept of operations, evaluation of supportability estimates of supporting organizations, and an integrated time-phased data base of combat, combat support, and combat service support forces and sustainment. Refinement of this data base will be contingent on the time available for course of action development. When approved, the course of action becomes the basis for the development of an operation plan or operation order. (Army) — **1.** Any sequence of acts that an individual or a unit may follow. **2.** A possible plan open to an individual or a commander that would accomplish or is related to accomplishment of the mission. **3.** A feasible way to accomplish a task or mission that follows the guidance given, will not result in undue damage or risk to the command, and is noticeably different from other actions being considered. See FMs 8-55, 71-100, 100-5, 100-15, and 101-5.

cover (JP1-02, NATO) — **1.** The action by land, air, or sea forces to protect by offense, defense, or threat of either or both. **2.** Those measures necessary to give protection to a person, plan, operation, formation, or installation from the enemy intelligence effort and leakage of information. **3.** The act of maintaining a continuous receiver watch with transmitter calibrated and available, but not necessarily available for immediate use. **4.** Shelter or protection (either natural or artificial). (DOD) **5.** Photographs or other recorded images which show a particular area of ground. (Army) — **1.** Shelter or protection from enemy observation that reduces the effects of enemy direct and indirect fire. **2.** A type of security operation that protects the force from surprise, develops the situation, and gives commanders time and space in which to respond to the enemy's actions. (See **covering force**.) See FMs 7-7, 7-8, 7-10, 17-95, 34-1, 34-130, 71-100, 71-123, 100-5, and 100-15. **C-II**

covered approach — **1.** Any route that offers protection against enemy fire. **2.** An approach made under the protection furnished by other forces or by natural cover. (See also concealment and cover.) See FMs 7-7, 7-8, and 7-10.

covering fire (JP 1-02, NATO) — **1.** Fire used to protect troops when they are within range of enemy small arms. **2.** In amphibious usage, fire delivered prior to the landing to cover preparatory operations such as underwater demolition or minesweeping. (See also fire.) See FMs 6-20 and 6-30.

covering force (JP 1-02, NATO) — **1.** A force operating apart from the main force for the purpose of intercepting, engaging, delaying, disorganizing, and deceiving the enemy before he can attack the force covered. **2.** Any body or detachment of troops which provides security for a larger force by observation, reconnaissance, attack, or defense, or by any combination of these methods. (See also cover and security operations.) See FMs 1-116, 6-20, 17-95, 71-100, 100-5, and 100-15.

covering force area (CFA) (JP 1-02, NATO) — The area forward of the forward edge of the battle area out to the forward positions initially assigned to the covering forces. It is here that the covering forces execute assigned tasks. See FMs 1-116, 6-20, 17-95, 71-100, 90-13, 100-5, and 100-15.

OPERATIONAL TERMS AND GRAPHICS

covert breach (Army) — A breach tactic used when the force must reduce lanes through enemy tactical or protective obstacles undetected. In the covert breach, suppression from the support force is a be-prepared task upon detection of the breach force or an on-order task once the breach is completed and the assault is initiated. Normally, this type of breach is used when mission success depends on achieving surprise at the expense of speed or mass. See FMs 5-71-100 and 90-13-1.

covert operation (JP 1-02) — An operation that is so planned and executed as to conceal the identity of or permit plausible denial by the sponsor. A covert operation differs from a clandestine operation in that emphasis is placed on concealment of identity of sponsor rather than on concealment of the operation.

cratering charge (JP 1-02, NATO) — A charge placed at an adequate depth to produce a crater. (Army) — A demolition charge used to create a type of point obstacle usually used to close a lane or block a road. (See also point obstacle and state of readiness.) See FMs 5-34, 5-71-100, and 5-102. **3-31**

crisis action planning (CAP) (JP 1-02) — **1.** The Joint Operation Planning and Execution System process involving the time-sensitive development of joint operation plans and orders in response to an imminent crisis. Crisis action planning follows prescribed crisis action procedures to formulate and implement an effective response within the time frame permitted by the crisis. **2.** The time-sensitive planning for the deployment, employment, and sustainment of assigned and allocated forces and resources that occurs in response to a situation that may result in actual military operations. Crisis action planners base their plan on the circumstances that exist at the time planning occurs. (See also deliberate planning.) See FMs 71-100, 100-5, 100-15, 101-5, and JP 5-0.

critical point (JP 1-02) — **1.** A key geographical point or position important to the success of an operation. **2.** In a point in time, a crisis or a turning point in an operation. **3.** A selected point along a line of march used for reference in giving instructions. **4.** A point where there is a change of direction or change in slope in a ridge or stream. **5.** Any point along a route of march where interference with a troop movement may occur. (Army) — Roadways, structures, and man-made or terrain features that limit the ability to maneuver. See FM 101-5.

cross-attachment — The exchange of subordinate units between units for a temporary period. Example: A tank battalion detaches a tank company that is subsequently attached to a mechanized infantry battalion, and the mechanized infantry battalion detaches a mechanized company that is then attached to the tank battalion. See FM 7-7.

cross-corridor — A terrain compartment, its long axis generally perpendicular to the direction of movement of a force. (See also compartment.) See FM 34-130.

cross-country movement — The movement of forces (usually tactical) across terrain without using roads and bridges. See FMs 7-7, 7-8 and 7-10.

crossing area (JP 1-02, NATO) — A number of adjacent crossing sites under the control of one commander. (Army) — A controlled access area for a river crossing operation used to decrease traffic congestion at the river. It is normally a brigade-sized area defined by lateral boundaries and release lines 3 to 4 kilometers (based on METT-T) from each side of the river. (See also crossing site and river crossing.) See FM 90-13. **3-28**

crossing area commander — The officer responsible for the control of all crossing units, assault units, and support forces while they are in the crossing area. See FMs 7-30, 71-100, 71-123, 71-100, 90-13, and 100-15.

crossing force (Army) — Normally a division size unit that has responsibility to establish the bridgehead. This is accomplished in four phases; the advance to the river, the assault across the river, the advance from the exit bank, and the securing of the bridgehead line. (See also bridgehead line, crossing area, and crossing site.) See FM 90-13.

crossing force commander (Army) — The individual designated to control the lead brigades during the assault across the river to secure the bridgehead line. (See also bridgehead.) See FMs 7-30, 71-100, 71-123, 90-13, and 100-15.

crossing site — The location along a water obstacle where the crossing can be made using amphibious vehicles, assault boats, rafts, bridges, or fording vehicles. See FMs 7-30, 71-100, 71-123, 90-13, and 100-15. **3-28**

crossing site commander — The individual, normally an engineer company commander or a platoon leader, responsible for the crossing means and crossing site, and for crossing the units sent to the crossing site. He commands the engineers operating the crossing means and the engineer regulating points (ERPs) at the call forward areas and staging areas for that site. (See also bridgehead.) See FMs 7-30, 71-100, 71-123, 90-13, and 100-15.

cross-loading (personnel) (JP 1-02) — A system of loading troops so that they may be disembarked or dropped at two or more landing or drop zones, thereby achieving unit integrity upon delivery. See FMs 1-103, 55-2, 55-10, 55-12, and 100-17.

cruise missile (JP 1-02) — Guided missile, the major portion of whose flight path to its target is conducted at approximately constant velocity; it depends on the dynamic reaction of air for lift and upon propulsion forces to balance drag.

culminating point — The point in time and space when the attacker can no longer accomplish his purpose, or when the defender no longer has the ability to accomplish his purpose. This can be due to factors such as combat power remaining, logistic support, weather, morale, and fatigue. See FM 101-5.

cultural resource — Monuments, nationally identifiable or distinctive buildings and structures, archives and libraries, ancient artifacts and structures, archaeologically important sites, historically important sites or structures, mosques, cathedrals, temples, other churches or sacred structures, sacred sites or areas, museums, and works of art.

D

daily intelligence summary (DISUM) (JP 1-02) — A report prepared in message form at the joint force headquarters that provides higher, lateral, and subordinate headquarters with a summary of all significant intelligence produced during the previous 24-hour period. The "as of" time for information, content, and submission time for the report will be as specified by the joint force commander. See FM 34-2.

damage assessment (JP 1-02, NATO) — **1.** The determination of the effect of attacks on targets. (DOD)
2. A determination of the effect of a compromise of classified information on national security. (See battle damage assessment (BDA).) See FM 34-1.

damage estimation (Army) — Analysis of data to estimate the damage that a specific weapon will cause to a target. (See also battlefield coordination element (BCE).) See FM 6-20 series.

OPERATIONAL TERMS AND GRAPHICS

danger area (JP 1-02) — **1.** A specified area above, below, or within which there may be potential danger. (DOD, NATO) **2.** In air traffic control, an airspace of defined dimensions within which activities dangerous to the flight of aircraft may exist at specified times. (Army) — Area in the vicinity of weapons or aircraft which can cause serious injury or death if occupied or passed through by individual soldiers or other equipment, such as the backblast area behind a TOW or Dragon. (See also restricted operations zone (ROZ).) See FMs 7-7 and 7-20.

danger close (JP 1-02, NATO) — In artillery and naval gunfire support, information in a call for fire to indicate that friendly forces are within 600 meters of the target. (Army) — For mortars, it indicates that friendly forces are within 400 meters of the target. (See also adjust fire and final protective fires (FPF).) See FMs 6-20 series, 7-20, 7-90, and 71-123.

datum (JP 1-02, NATO) — Any numerical or geometrical quantity or set of such quantities which may serve as reference or base for other quantities. Where the concept is geometric, the plural form is "datums" in contrast to the normal plural "data."

datum (geodetic) (JP 1-02) — A reference surface consisting of five quantities: the latitude and longitude of an initial point, the azimuth of a line from that point, and the parameters of the reference ellipsoid. (Army) — The mathematical model of the earth used to calculate the coordinates on any map. Different nations use different datums for printing coordinates on their maps. The datum is usually referenced in the marginal information of each map. See FM 101-5.

day of supply (DOS) (JP 1-02) — See one day's supply. (Army) — Normally used to express the amount of supplies pre-positioned in an area of operations or in a storage area. (See also controlled supply rate (CSR).) See FMs 7-20, 63-20, 71-100, 71-123, 100-10, and 100-15.

dazzle (JP 1-02) — Temporary loss of vision or a temporary reduction in visual acuity. (Army) — May also be applied to effects on optics. (See also directed-energy warfare (DEW).) See FM 71-123.

D-day (JP 1-02) — The unnamed day on which a particular operation commences or is to commence. (Army) — The execution date of an operation. The use of D-day allows for planning and sequencing of events when a specific calendar date cannot be established. References to days preceding or following D-day use a plus or minus sign and an Arabic numeral following the letter "D." Example: D-3 is 3 days prior to D-day; D+7 is 7 days after D-day. (See also C-day.) See FMs 71-100, 100-15, and 101-5.

deadline (JP 1-02) — To remove a vehicle or piece of equipment from operation or use for one of the following reasons: **a.** is inoperative due to damage, malfunctioning, or necessary repairs. The term does not include items temporarily removed from use by reason of routine maintenance, and repairs that do not affect the combat capability of the item; **b.** is unsafe; and **c.** would be damaged by further use. (Army) — An item in such condition is placed on the deadline or not operationally ready list provided to the commander daily. (See also full mission capable (FMC)).

dead space (JP 1-02, NATO) — **1.** An area within the maximum range of a weapon, radar, or observer which cannot be covered by fire or observation from a particular position because of intervening obstacles, the nature of the ground, or the characteristics of the trajectory, or the limitations of the pointing capabilities of the weapons. **2.** An area or zone which is within range of a radio transmitter, but in which a signal is not received. **3.** The volume of space above and around a gun or guided missile system into which it cannot fire because of mechanical or electronic limitations. See FMs 7-7, 7-20, 17-12, and 23-1.

debarkation (JP 1-02) — The unloading of troops, equipment, or supplies from a ship or aircraft. (See also embarkation.) See FM 55-12.

debriefing (Army) — The questioning of individuals who are sources of information in a strategic or operational environment to obtain information in response to command- and nation-level intelligence needs. See FM 34-52.

deception (JP 1-02, NATO) — Those measures designed to mislead the enemy by manipulation, distortion, or falsification of evidence to induce him to react in a manner prejudicial to his interests. (Army) — The goal is to make an enemy more vulnerable to the effects of weapons, maneuver, and operations of friendly forces. (See also **deception operation**, **demonstration**, and **imitative electromagnetic deception (IED)**.) See FMs 34-1 and 90-2. **3-7**

deception means (JP 1-02) — Methods, resources, and techniques that can be used to convey information to the deception target. **3-7** There are three categories of deception means: **a. physical means** — Activities and resources used to convey or deny selected information to a foreign power. (Examples: military operations, including exercises, reconnaissance, training activities, and movement of forces; the use of dummy equipment and devices; tactics; bases, logistic actions, stockpiles, and repair activity; and test and evaluation activities.) **b. technical means** — Military material resources and their associated operating techniques used to convey or deny selected information to a foreign power through the deliberate radiation, reradiation, alteration, absorption, or reflection of energy; the emission or suppression of chemical or biological odors; and the emission or suppression of nuclear particles. **c. administrative means** — Resources, methods, and techniques to convey or deny oral, pictorial, documentary, or other physical evidence to a foreign power. See JP 3-58.

deception operation — A military operation conducted to mislead the enemy. (See also **attack**, **demonstration**, **display**, **feint**, **imitative electromagnetic deception (IED)**, and **ruse**.) See FM 90-2. **3-7**

decision point (DP) (Army) — An event, an area, a line, or a point on the battlefield where tactical decisions are required resulting from the war-gaming process before the operation order. Decision points do not dictate commander's decisions, they only indicate that a decision is required, and they indicate when and where the decision should be made to have the maximum effect on friendly or enemy courses of action. (See also **decision support matrix (DSM)**, **decision support template (DST)**, and **war gaming**.) See FM 101-5. **3-25**

decision support matrix (DSM) — An aid used by the commander and staff to make battlefield decisions. It is a staff product of the war-gaming process which lists the decision point, location of the decision point, the criteria to be evaluated at the point of the decision, the action or options to occur at the decision point, and the unit or element that is to act and has responsibility to observe and report the information affecting the criteria for the decision. (See also **branch**, **decision point (DP)**, **decision support template (DST)**, **sequel**, and **war gaming**.) See FM 101-5.

decision support template (DST) — A staff product initially used in the war-gaming process which graphically represents the decision points and projected situations and indicates when, where, and under what conditions a decision is most likely to be required to initiate a specific activity (such as a branch or sequel) or event (such as lifting or shifting of fires.) (See also **decision point (DP)**, **decision support matrix (DSM)**, **intelligence preparation of the battlefield (IPB)**, and **war gaming**.) See FMs 34-130 and 101-5.

decisive engagement (JP 1-02) — In land and naval warfare, an engagement in which a unit is considered fully committed and cannot maneuver or extricate itself. In the absence of outside assistance, the action must be fought to a conclusion and either won or lost with the forces at hand. (Army) — In some situations, this is a desired result in order to hold key terrain, defeat a specific enemy force, or secure a

OPERATIONAL TERMS AND GRAPHICS

specific objective. In this situation, the unit can receive additional forces or support to be able to disengage.

decisive point (Army) — **1.** A point, if retained, that provides a commander with a marked advantage over his opponent. Decisive points are usually geographic in nature but could include other physical elements, such as enemy formations, command posts, and communications nodes. **2.** A time or location where enemy weakness is positioned that allows overwhelming combat power to be generated against it. It could be an enemy weakness to be exploited or a time when the combat potential of the enemy force is degraded. **3.** Conveys to subordinates a potential point of decision that the commander has identified through his estimate process to apply overwhelming combat power. (See also combat power, decision point (DP), and synchronization.) See FM 100-5.

decisive terrain — Key terrain that has an extraordinary impact on the mission. Decisive terrain is relatively rare and will not be present in every situation. To designate terrain as decisive is to recognize that the successful accomplishment of the mission, whether offensive or defensive, depends on seizing or retaining it. The commander designates decisive terrain to communicate its importance in his concept of operations, first to his staff and, later, to subordinate commanders. (See also key terrain.) See FMs 34-130 and 101-5.

declination (JP 1-02, NATO) — The angular distance to a body on the celestial sphere measured north or south through 90 degrees from the celestial equator along the hour circle of the body. Comparable to latitude on the terrestrial sphere. (Army) — In navigation, at a given place and time, the angle between the grid north meridian and the true north meridian and or magnetic north meridian measured in degrees or mils east or west. These change in relationship to the magnetic north meridian annually based on the drift of the magnetic pole. See FMs 21-26 and 1-111.

deconflict — To reconcile or resolve a conflict in responsibility, area of operations, airspace, or interests in order to accomplish smooth operations without undesired redundancy or threat of fratricide. (See also air mission brief (AMB), airspace control area (ACA), area of operations (AO), battlefield coordination element (BCE), and boundary.) See FMs 1-111, 71-100, 100-15, 100-103, and 101-5.

decontaminant — Any substance used to break down, neutralize, or remove a chemical, biological, or radioactive material posing a threat to personnel or equipment. See FM 3-5.

decontamination (JP 1-02, NATO) — The process of making any person, object, or area safe by absorbing, destroying, neutralizing, making harmless, or removing chemical or biological agents, or by removing radioactive material clinging to or around it. (Army) — The reduction of the contamination hazard by removal or neutralization of hazardous levels of nuclear, biological, and chemical (NBC) contamination on personnel and materiel. The three levels of decontamination are immediate, operational, and thorough. (See also patient decontamination.) See FMs 3-5 and 8-10-7. **3-36** **4-19**

decoy (JP 1-02) — An imitation in any sense of a person, object, or phenomenon which is intended to deceive enemy surveillance devices or mislead enemy evaluation. Also called dummy. See FM 90-2 and JP 3-58. **3-7**

deep maneuver — An offensive operation that employs ground or aviation maneuver forces in support of deep operations which involve the movement of combat forces in relation to the enemy, supported by fires or fire potential from all available sources. (See also deep operations and deep supporting fire.)

deep operations (Army) — Those operations directed against enemy forces and functions which are not in contact at the forward line of troops (FLOT), line of departure, or friendly perimeter and are between the FLOT or perimeter and the forward boundary of the unit conducting the operation. These operations

employ long-range fires, air and ground maneuver, and command and control warfare to defeat the enemy by denying him freedom of action; disrupting his preparation for battle and his support structure; and disrupting or destroying the coherence and tempo of his operations. (See also decisive point, forward boundary, and simultaneous attack in depth.) See FMs 1-112, 6-20-30, 100-5, and 100-15.

deep supporting fire (JP 1-02) — Fire directed on objectives not in the immediate vicinity of our forces, for neutralizing and destroying enemy reserves and weapons, and interfering with enemy command, supply, communications, and observations. (See also deep operations, forward boundary, and simultaneous attack in depth.) See FMs 1-111, 6-20, 7-20, 7-30, 17-95, 71-100, 71-123, 100-15, and 101-5.

defeat (Army) — A tactical task to either disrupt or nullify the enemy force commander's plan and subdue his will to fight so that he is unwilling or unable to further pursue his adopted course of action and yields to the will of his opponent. (See also decisive point.) See FMs 7-30, 71-100, 71-123, 100-5, and 100-15.

defeat mechanism (Army) — That singular action, not necessarily the type of force or unit, that ensures the success of a course of action. It includes locating objectives and identifying specific targets. (See also center of gravity.) See FM 101-5.

defend — A combat operation designed to defeat an attacker and prevent him from achieving his objectives. It employs all means and methods available to prevent, resist, or destroy an enemy attack. Forms of defensive operations are area and mobile. Choices of defensive operations are in-depth and forward. The defensive techniques are defend in sector, defend a battle position, and defend a strong point. See FMs 7-30, 71-100, 71-123, 100-5, and 100-15.

defend a battle position — A technique that places a unit in a battle position (BP) to concentrate its fires, to limit its maneuver, or to place it in an advantageous position to counterattack. The BP is a general location on the ground. The commander positions his forces on the best terrain within and in the vicinity of the BP. The commander may position security forces forward of and about the BP. He can also locate combat support and combat service support elements outside the BP. The commander can maneuver his forces freely within the BP and seize the initiative to maneuver outside of the BP to attack enemy forces provided that it does not interfere with the commander's concept. See FMs 7-30, 71-100, 71-123, 100-5, and 100-15.

defend a strong point — A form of defend a battle position that requires more engineer work and may be required to be held at all costs. It denies key terrain to the enemy and forces his movement in a different direction.

defense in depth (JP 1-02, NATO) — The siting of mutually supporting defense positions designed to absorb and progressively weaken attack, prevent initial observations of the whole position by the enemy, and to allow the commander to maneuver his reserve.

defend in sector — A technique that requires a defending unit to prevent enemy forces from passing beyond the rear boundary of the sector while retaining flank security and ensuring integrity of effort within the parent unit's scheme of maneuver. Initial positions generally are established as far forward as possible, but a commander may use any technique to accomplish the mission. The higher commander will normally assign a no-penetration criteria. Example: Do not allow penetration of PL NAME by 12 or more tanks or infantry fighting vehicles. See FMs 7-30, 71-100, 71-123, 100-5, and 100-15.

defense readiness conditions (DEFCON) (JP 1-02) — A uniform system of progressive alert postures for use between the Chairman of the Joint Chiefs of Staff and the commanders of unified and specified commands and for use by the Services. Defense readiness conditions are graduated to match situations

OPERATIONAL TERMS AND GRAPHICS

of varying military severity (status of alert). Defense readiness conditions are identified by the short title DEFCON (5), (4), (3), (2), and (1), as appropriate. See FM 100-5.

defensive counterair (DCA) (Army) — Operations conducted to protect against attack from enemy systems that operate in the atmosphere (for example: a system used to destroy enemy aircraft attacking friendly surface forces.).

defensive counterspace (DCS) (Army) — Operations conducted to defend against attacks by systems operating in space.

defensive operations — Operations conducted with the immediate purpose of causing an enemy attack to fail. Defensive operations also may achieve one or more of the following: gain time; concentrate forces elsewhere; wear down enemy forces as a prelude to offensive operations; and retain tactical, strategic, or political objectives. (See also area defense, defend, and mobile defense.) See FMs 7-30, 71-100, 71-123, 100-5, and 100-15.

defilade (JP 1-02, NATO) — **1.** Protection from hostile observation and fire provided by an obstacle such as a hill, ridge, or bank. **2.** A vertical distance by which a position is concealed from enemy observation. **3.** To shield from enemy fire or observation by using natural or artificial obstacles. See FMs 7-8, 7-20, 17-12, 23-1, and 71-123.

defile — A narrow gorge or pass that tends to prevent easy movement of troops. See FM 7-7, 7-8, and 7-10.

degree of risk (nuclear) (JP 1-02) — As specified by the commander, the risk to which friendly forces may be subjected from the effects of the detonation of a nuclear weapon used in the attack of a close-in enemy target; acceptable degrees of risk under differing tactical conditions are emergency, moderate, and negligible. (See also emergency risk (nuclear), moderate risk (nuclear), negligible risk (nuclear), operation exposure guide (OEG), and radiation status (RS).) See FM 3-3-1, JPs 3-12.2, and 3-12.3.

delay from alternate positions — Requires two maneuver units in a single sector. While the first is fighting, the second occupies the next position in depth and prepares to assume responsibility for the operation and support by fire the disengagement of the first force. The first force disengages and passes through or around the second, moving to resume the delay from a position in greater depth, while the second force takes up the fight. **C-9**

delay forward of a specified line for a specified time or specified event — Used to prevent enemy forces from reaching the specified area earlier than the specified time or event, regardless of the cost; presents a higher risk to the unit. This can be done by units in the covering force area or in the main battle area. (See also retirement, retrograde, and withdrawal.) **C-9**

delaying operation (JP 1-02, NATO) — An operation in which a force under pressure trades space for time by slowing down the enemy's momentum and inflicting maximum damage on the enemy without, in principle, becoming decisively engaged. (Army) — Usually conducted when the commander needs time to concentrate, preserve, or withdraw forces; to establish defenses in greater depth; to economize in an area; to cover a defending or withdrawing unit; to protect a friendly unit's flank; or to complete offensive actions elsewhere. In the delay, the destruction of the enemy force is secondary to slowing his advance to gain time. See FMs 17-95, 71-100, 100-5, and 100-15. **C-9**

delay in sector — Used to slow and defeat as much of the enemy as possible without sacrificing the tactical integrity of the unit; presents low risk to the unit. Delay in sector can be done by forces in the covering force area or in the main battle area. **C-9**

delay from successive positions — Performed when a sector is so wide that available forces cannot occupy more than a single tier of positions at a time. Maneuver units delay continuously on and between positions throughout their sectors, fighting rearward from one position to another, holding each as long as possible or for a specified time. **C-9**

delegation of authority (JP 1-02, NATO) — The action by which a commander assigns part of his or her authority commensurate with the assigned task to a subordinate commander. While ultimate responsibility cannot be relinquished, delegation of authority carries with it the imposition of a measure of responsibility. The extent of the authority delegated must be clearly stated. (See also command.) See FM 100-34.

deliberate attack (JP 1-02, NATO) — A type of offensive action characterized by preplanned coordinated employment of firepower and maneuver to close with and destroy or capture the enemy. (Army) — An attack planned and carefully coordinated and rehearsed with all concerned elements based on thorough reconnaissance, evaluation of all available intelligence and relative combat strength, analysis of various courses of action, and other factors affecting the situation. It generally is conducted against a well-organized defense when a hasty attack is not possible or has been conducted and failed. (See also attack.) See FMs 7-8, 7-20, 17-12, 23-1, 71-100, 71-123, 100-5, and 100-15.

deliberate breaching (JP 1-02, NATO) — The creation of a lane through a minefield or a clear route through a barrier or fortification, which is systematically planned and carried out. (Army) -- A deliberate breach is conducted when it is not possible or necessary to cross an obstacle in stride, or after an in-stride breach has failed. A deliberate breach is characterized by detailed planning and preparation, and executed with whatever resources are available. (See also assault breach, assault force, breach, breach force, covert breach, in-stride breach, and support force.) See FMs 5-71-100, 5-101, 7-8, 7-20, 17-12, 71-123, and 90-13-1.

deliberate crossing (JP 1-02, NATO) — A crossing of an inland water obstacle that requires extensive planning and detailed preparation. (Army) — A crossing conducted against a well-organized defense when a hasty river crossing has failed or is not possible. It requires thorough reconnaissance, extensive intelligence, detailed planning, preparation, centralized control, and extensive rehearsals. (See also bridgehead, bridgehead line, hasty crossing, and river crossing.) See FMs 7-7, 7-20, 23-1, 71-123, 90-13, and 100-15. **3-28**

deliberate defense (JP 1-02, NATO) — A defense normally organized when out of contact with the enemy or when contact with the enemy is not imminent and time for organization is available. It normally includes an extensive fortified zone incorporating pillboxes, forts, and communications systems. (See also defend, defense in depth, and forward defense.) See FMs 7-8, 7-20, 17-12, 23-1, and 71-123.

deliberate planning (JP 1-02) — **1.** The Joint Operation Planning and Execution System process involving the development of joint operation plans for contingencies identified in joint strategic planning documents. Conducted principally in peacetime, deliberate planning is accomplished in prescribed cycles that complement other Department of Defense planning cycles in accordance with the formally established Joint Strategic Planning System. **2.** A planning process for the deployment and employment of apportioned forces and resources that occurs in response to a hypothetical situation. Deliberate planners rely heavily on assumptions regarding the circumstances that will exist when the plan is executed. (See also contingency, fragmentary order, operation order (OPORD), and warning order (WARNO).) See FM 101-5 and JP 5-0.

deliberate smoke — smoke operations characterized by integrated planning and extended duration of smoke support. See FM 3-50. **3-24**

OPERATIONAL TERMS AND GRAPHICS

demilitarized zone (DMZ) (JP 1-02, NATO) — A defined area in which the stationing, or concentrating of military forces, or the retention or establishment of military installations of any description, is prohibited. (Army) — That space created to neutralize certain areas from military occupation and activity; generally speaking, they are areas that both sides claim and where control by one could constitute a direct threat to the other. Third-party forces are usually not present and the space is patrolled by observer teams or surveyed from observation posts. (See also buffer zone and zone of separation (ZOS).) See FMs 100-20 and 100-23.

demobilization (Army) — The act of returning the force and materiel to a premobilization posture or to some other approved posture. It also involves returning the mobilized portion of the industrial base to peacetime conditions. (See also mobilization.) See FMs 100-15 and 100-17.

demolition (JP 1-02, NATO) — The destruction of structures, facilities, or material by use of fire, water, explosives, mechanical, or other means. See FMs 5-71-100 and 5-100.

demolition firing party (JP 1-02) — The party at the site which is technically responsible for the demolition. (Army) — The group of soldiers who actually initiate detonation or fire the demolitions. (See also demolition guard and state of readiness.) See FMs 5-71-100 and 5-100.

demolition guard (JP 1-02, NATO) — A local force positioned to ensure that a target is not captured by an enemy before orders are given for its demolition and before the demolition has been successfully fired. The commander of the demolition guard is responsible for the tactical control of all troops at the demolition site, including the demolition firing party. The commander of the demolition guard is responsible for transmitting the order to fire to the demolition firing party. See FMs 5-71-100 and 5-100.

demolition target (JP 1-02, NATO) — A target of known military interest identified for possible future demolition. See FMs 5-71-100 and 5-100.

demonstration (JP 1-02, NATO) — An attack or show of force on a front where a decision is not sought, made with the aim of deceiving the enemy. (Army) — **1.** Type of attack that is a deception similar to a feint, with the exception that no contact with the enemy is sought. **2.** In stability and support operations, an operation by military forces in sight of an actual or potential enemy to show military capabilities. (See also show of force and deception operation.) See FMs 7-30, 71-100, 71-123, 90-2, 100-5, and 100-15.

D-I

denial measure (JP 1-02, NATO) — An action to hinder or deny the enemy the use of space, personnel, or facilities. It may include destruction, removal, contamination, or erection of obstructions.

denial operation (Army) — An operation designed to prevent or hinder enemy occupation of, or benefit from, areas or objects having tactical or strategic value. See FM 100-25.

denied area (JP 1-02) — An area under enemy or unfriendly control in which friendly forces cannot expect to operate successfully within existing operational constraints and force capabilities. (Army) — An area that is operationally unsuitable for general purpose forces due to political, tactical, environmental, or geographic reasons. It is a primary area for special operations forces. See FM 100-25.

departure airfield (JP 1-02) — An airfield on which troops and/or materiel are enplaned for flight. (See also aerial port of debarkation and aerial port of embarkation.) See FM 55-12.

departure point (JP 1-02, NATO) — **1.** A navigational check point used by aircraft as a marker for setting course. **2.** In amphibious operations, an air control point at the seaward end of the helicopter approach lane system from which helicopter waves are dispatched along the selected helicopter approach lane to

the initial point. (Army) — That point, assembly area, airfield, or other location from which an aircraft begins an aeronautical mission. (See also air control point (ACP), air corridor, and pickup zone (PZ).) See FMs 1-111, 1-112, 1-116, and 100-103.

deployable intelligence support element (DISE) (Army) — A tactically tailored intelligence support team, uniquely configured commander's intelligence staff with assured communications, automated intelligence processing, and broadcast downlink systems needed to conduct split-based operations. The DISE is not a permanent organization, specific unit, or specific quantity of equipment. As the forward element of the analysis and control element (ACE), the DISE is normally the foundation on which a full ACE is formed, if formed, after the lodgment is secured and subsequent operations begin. See FM 34-1.

deployment (Army) — **1.** The movement of forces within areas of operations. **2.** The positioning of forces into a formation for battle. **3.** The relocation of forces and materiel to desired areas of operations. **4.** Deployment encompasses all activities from origin or home station through destination, specifically including intracountry United States, intertheater, and intratheater movement legs, staging, and holding areas. **5.** Those activities required to prepare and move a force and its sustainment equipment and supplies to the area of operations in response to a crisis or natural disaster. (See also force projection.) See FM 55-12, 71-100, 100-5, 100-15, and 100-17.

depot (JP 1-02) — **1. supply** — An activity for the receipt, classification, storage, accounting, issue, maintenance, procurement, manufacture, assembly, research, salvage, or disposal of material. **2. personnel** — An activity for the reception, processing, training, assignment, and forwarding of personnel replacements. (See also classes of supply and combat service support.) See FM 10-1.

depth (Army) — The extension of operations in time, space, resources, and purpose. See FM 100-5.

desired ground zero (DGZ) (JP 1-02, NATO) — The point on the surface of the Earth at, or vertically below or above, the center of a planned nuclear detonation. (Army) — The aiming point for the weapon.

3-34

destroy — **1.** A tactical task to physically render an enemy force combat-ineffective unless it is reconstituted. **2.** To render a target so damaged that it cannot function as intended nor be restored to a usable condition without being entirely rebuilt. (See also defeat.) See FMs 1-111, 5-100, 6-20, 71-100, 100-5, and 100-15. **C-9**

destruction — **1.** When referring to the effects of field artillery fires, a target out of action permanently, or 30 percent casualties or material damage. Destruction requires large expenditures of ammunition and is prohibitive unless using improved conventional munitions (ICM) or "smart weapons." **2.** When used in an attack helicopter mission, the percentage of destroyed or disabled vehicles must be specified by the higher commander. See FMs 1-112 and 6-20 series.

destruction fire (JP 1-02) — Fire delivered for the sole purpose of destroying material objects. (See also fire support and destroy.) See FM 6-20 series.

detachment (JP 1-02, NATO) — **1.** A part of a unit separated from its main organization for duty elsewhere. **2.** A temporary military or naval unit formed from other units or parts of units. (Army) — **1.** A unit that is serving away from the organization to which it is organic and to which it remains assigned. **2.** A detached unit may function as an independent organization, or it may be attached to or serve with or under another organization. (See also assign, attach, command relationship, and operational control (OPCON).) See FMs 7-20, 7-30, 71-100, 71-123, and 100-15.

OPERATIONAL TERMS AND GRAPHICS

detachment left in contact (DLIC) — An element at any echelon conducting a withdrawal not under pressure. This element may comprise as much as one-third of the next higher command's organization. Its primary purpose is to remain behind to deceive the enemy into believing the parent unit is still in position as the majority of units withdraw. If the withdrawal is discovered and the enemy attacks, the DLIC defends or delays within its capability. It disengages and withdraws after the main body has begun movement to the next mission. (See also breakout, delaying operation, and retrograde.) See FM 7-20, 7-30, 17-95, 71-100, 100-5, and 100-15.

detailed equipment decontamination — In thorough decontamination, removing, neutralizing, or reducing contamination on interior and exterior surfaces of unit equipment to negligible risk levels to allow the removal of mission-oriented protective posture (MOPP) gear or reduction in MOPP level for extended periods. See FM 3-5. **3-36**

detailed troop decontamination — In thorough decontamination, reducing mission-oriented protective posture (MOPP) levels for extended periods by decontaminating individual fighting equipment to negligible risk levels, removing contaminated MOPP gear including protective masks, decontaminating protective masks, and monitoring personnel and equipment for effectiveness of decontamination. See FM 3-5. **3-36**

detained — *See* missing.

detainee (JP 1-02) — A term used to refer to any person captured or otherwise detained by an armed force. See FMs 34-1 and 100-20. **3-37, 3-38**

deterrence (JP 1-02) — The prevention from action by fear of the consequences. Deterrence is a state of mind brought about by the existence of a credible threat of unacceptable counteraction. See FM 100-20.

detonating cord (JP 1-02, NATO) — A waterproof, flexible fabric tube containing a high explosive designed to transmit the detonation wave. (See also demolition.) See FMs 5-71-100 and 5-100.

dew point spread — The degrees of difference between the air temperature and the dew point that indicate if fog will begin to form. See FMs 1-111, 1-112, and 1-116.

diamond formation — A tactical or movement formation that is a variation of the box formation with one maneuver unit leading, maneuver units positioned on each flank, and the remaining maneuver unit to the rear. (See also box formation and formation.) See FMs 7-7 and 71-123.

died of wounds (DOW) — A hostile or battle casualty who dies after having reached a medical treatment facility. (See also hostile casualty and killed in action (KIA).) See FM 8-55.

died of wounds received in action (DWRIA) (JP 1-02) — A casualty category applicable to a hostile casualty, other than the victim of a terrorist activity, who dies of wounds or other injuries received in action after having reached a medical treatment facility.

digitization — **1.** The near-real-time transfer of battlefield information between diverse fighting elements to permit a shared awareness of the tactical situation. **2.** Leveraging information-age technologies to enhance the art of command and facilitate the science of control. (See also command and control warfare (C²W) and information warfare (IW).) See FMs 71-100 and 100-15.

direct action (DA) (JP 1-02) — Short-duration strikes and other small-scale offensive actions by special operations forces to seize, destroy, capture, recover, or inflict damage on designated personnel or materiel. In the conduct of these operations, special operations forces may employ raid, ambush, or direct

assault tactics; emplace mines and other munitions; conduct standoff attacks by fire from air, ground, or maritime platforms; provide terminal guidance for precision-guided munitions; and conduct independent sabotage. See FM 31-20.

direct action mission — In special operations, a specified act involving operations of an overt, clandestine, or low-visibility nature conducted primarily by special operations forces in hostile or denied areas. (See also direct action (DA) and direct action operations.) See FM 31-20.

direct action operations — Short-duration offensive actions by special operations forces (SOF) to seize, destroy, or inflict damage on a specified target; or to destroy, capture, or recover designated personnel or materiel. In the conduct of these operations, SOF may employ raid, ambush, or direct assault tactics; emplace mines and other munitions; conduct standoff attacks by fire from air, ground, or maritime platforms; provide terminal guidance for precision-guided munitions; and conduct independent sabotage. See FMs 31-20 and 100-25.

directed-energy (DE) (JP 1-02) — An umbrella term covering technologies that relate to the production of a beam of concentrated electromagnetic energy or atomic or subatomic particles. (Army) — Lasers, high-energy microwave, and particle beams are all examples. (See also directed-energy warfare (DEW).)

directed-energy warfare (DEW) (JP 1-02) — Military action involving the use of directed-energy weapons, devices, and countermeasures to either cause direct damage or destruction of enemy equipment, facilities, and personnel, or to determine, exploit, reduce, or prevent hostile use of the electromagnetic spectrum through damage, destruction, and disruption. It also includes actions taken to protect friendly equipment, facilities, and personnel and retain friendly use of the electromagnetic spectrum. (Army) — Directed-energy weapons are used like direct fire weapons. (See also directed energy (DE) and direct fire.) See FM 71-123.

directed obstacle — An obstacle directed by a higher commander as a specified task to a subordinate unit. See FM 90-7.

directed target — Target directed by the responsible commander to be prepared for demolition or destroyed to support his intent. See FMs 5-71-100 and 5-100.

direct exchange (JP 1-02) — A supply method of issuing serviceable materiel in exchange for unserviceable materiel on an item-for-item basis. See FMs 10-1 and 63-20.

direct fire (JP 1-02) — Gunfire delivered on a target, using the target itself as a point of aim for either the gun or the director. (Army) — Fire includes gun, missile, or rocket fire. Fire directed at a target that is visible to the aimer or firing unit. See FMs 1-112, 7-7, 7-8, 7-20, 7-95, and 71-123.

direction of attack (JP 1-02) — A specific direction or route that the main attack or center of mass of the unit will follow. The unit is restricted, required to attack as indicated, and is not normally allowed to bypass the enemy. The direction of attack is used primarily in counterattacks or to ensure that supporting attacks make maximal contribution to the main attack. (Army) — Normally used at battalion and lower levels. Direction of attack is a more restrictive control measure than axis of advance, and units are not free to maneuver off the assigned route. It usually is associated with infantry units conducting night attacks, or units involved in limited visibility operations and in counterattacks. (See also axis of advance.) See FMs 7-8, 7-20, 7-30, 71-100, 71-123, and 100-15. **3-15, 3-16**

direction finding (JP 1-02) — A procedure for obtaining bearings of radio frequency emitters by using a highly directional antenna and a display unit on an intercept receiver or ancillary equipment.

OPERATIONAL TERMS AND GRAPHICS

direction of fire — The direction on which a cannon, rocket, gun, or missile is laid. It represents the direction to the most significant threat in the target area. See FMs 6-20, 7-90, 7-91, 17-12, and 23-1.

direct laying (JP 1-02) — Laying in which the sights of weapons are aligned directly on the target. (Army) — Normally used in conjunction with mortars and sometimes artillery. See FMs 6-20 and 7-90.

direct pressure force — A force employed in a pursuit operation that orients on the enemy main body to prevent enemy disengagement or defensive reconstitution prior to envelopment by the encircling force. It normally conducts a series of hasty attacks to slow the enemy's retirement by forcing him to stand and fight. (See also encircling force and pursuit.) See FMs 1-112, 7-30, 71-100, 71-123, and 100-15.

direct support (DS) (JP 1-02) — A mission requiring a force to support another specific force and authorizing it to answer directly the supported force's request for assistance. (NATO) — The support provided by a unit or formation not attached to, nor under command of, the supported unit or formation, but required to give priority to the support required by that unit or formation. (See also general support (GS), general support reinforcing (GSR), and reinforcing (R).) See FMs 6-20, 7-30, 71-100, 71-123, and 100-15.

direct support artillery (JP 1-02 NATO) — Artillery whose primary task is to provide fire requested by the supported unit. (See also general support (GS).) See FM 6-series.

direct support unit (DSU) — Unit providing supply and maintenance support directly to a using or consuming unit.

disengagement — Breaking contact with the enemy and moving to a point where the enemy can neither observe nor engage the unit by direct fire. See FMs 7-8, 7-20, 7-30, 71-100, 71-123, and 100-15.

dislocated civilian (Army) — A generic term that describes a civilian who has been forced to move by war, revolution, or natural or man-made disaster from his or her home to some other location. Dislocated citizens include displaced persons, refugees, evacuees, stateless persons, or war victims. Legal and political considerations define the subcategories of a dislocated civilian. See FM 100-20.

dispersion(JP 1-02, NATO) — **1.** A scattered pattern of hits around the mean point of impact of bombs and projectiles dropped or fired under identical conditions. **2.** In anti-aircraft gunnery, the scattering of shots in range and deflection about the mean point of explosion. **3.** The spreading or separating of troops, materiel, establishments, or activities which are usually concentrated in limited areas to reduce vulnerability. **4.** In chemical and biological operations, the dissemination of agents in liquid or aerosol form. **5.** In airdrop operations, the scatter of personnel and/or cargo on the drop zone. See FMs 6-20, 17-12, 23-1, 44-100, 71-100-2, and 71-123.

displace — To leave one position and take another. Forces may be displaced laterally to concentrate combat power in threatened areas. (See also defend and delaying operation.) See FMs 6-20, 7-7, 7-8, 7-10, 7-20, 17-95, and 71-123.

displaced person (JP 1-02, NATO) — A civilian who is involuntarily outside the national boundaries of his or her country. (See also dislocated civilian and refugee.) See FMs 100-20 and 100-23.

display(Army) — A deception technique to mislead the enemy's visual senses, including his observation by radar, camera, infrared device, or the human eye. Displays include simulations, disguises, portrayals, or some combination of these measures. See FMs 71-100, 90-2, 100-5, and 100-15.

disposition (JP 1-02, NATO) — **1.** Distribution of the elements of a command within an area, usually the exact location of each unit headquarters and the deployment of the forces subordinate to it. **2.** A prescribed arrangement of the stations to be occupied by the several formations and single ships of a fleet, or major subdivisions of a fleet, for any purpose, such as cruising, approach, maintaining contact, or battle. **3.** A prescribed arrangement of all the tactical units composing a flight or group of aircraft. (DOD) **4.** The removal of a patient from a medical treatment facility by reason of return to duty, transfer to another treatment facility, death, or other termination of medical case. (See also deployment and dispersion.) See FMs 7-30, 71-100, 71-123, 100-5, 100-15, and 101-5.

disrupt— A tactical task or obstacle effect that integrates fire planning and obstacle effort to break apart an enemy's formation and tempo, interrupt the enemy's timetable, or cause premature commitment of enemy forces, or the piecemealing of his attack. See FMs 90-7 and 100-5. **3-31** **C-9**

distribution point (JP 1-02, NATO) — A point at which supplies and/or ammunition, obtained from supporting supply points by a division or other unit, are broken down for distribution to subordinate units. Distribution points usually carry no stocks; items drawn are issued completely as soon as possible. See FM 10-1.

distribution system (JP 1-02) — That complex of facilities, installations, methods, and procedures designed to receive, store, maintain, distribute, and control the flow of military materiel between the point of receipt into the military system and the point of issue to using activities and units. See FMs 10-1 and 100-10.

diversion (JP 1-02) — **1.** The act of drawing the attention and forces of an enemy from the point of the principal operation; an attack, alarm, or feint that diverts attention. **2.** A change made in a prescribed route for operational or tactical reasons. A diversion order will not constitute a change of destination. **3.** A rerouting of cargo or passengers to a new transshipment point or destination or on a different mode of transportation prior to arrival at ultimate destination. (See also deception operation and demonstration.) See FMs 55-12, 71-100, 100-5, and 100-15.

division PSYOP support element (DPSE) (Army) — A tactical psychological operation support element that provides PSYOP support to a division. See FM 33-1 and JP 3-53.

division support area (DSA) (Army) — An area normally located in the division rear and often positioned near air-landing facilities along the main supply route. The DSA contains the portions of the division rear command post, DISCOM CP, and units organic and attached to the DISCOM. It may also contain COSCOM units supporting the division and nondivisional units in the division area. See FM 63-2. **3-39**

doctrinal template — A model based on postulated enemy tactical doctrine. It generally portrays frontages, depths, echelon spacing, and force composition, as well as his disposition of combat, combat support, and combat service support units for a given type of operation. It portrays how the enemy would like to fight if he was not constrained. (See also decision support template (DST), event template, intelligence preparation of the battlefield (IPB), and situational template.) See FMs 34-1 and 34-130.

doctrine(JP 1-02, NATO) — Fundamental principles by which the military forces or elements thereof guide their actions in support of national objectives. It is authoritative but requires judgment in application. See FM 100-5.

domestic emergencies (JP 1-02) — Emergencies affecting the public welfare and occurring within the 50 states, District of Columbia, Commonwealth of Puerto Rico, US possessions and territories, or any

OPERATIONAL TERMS AND GRAPHICS

political subdivision thereof, as a result of enemy attack, insurrection, civil disturbance, earthquake, fire, flood, or other public disasters, or equivalent emergencies that endanger life and property or disrupt the usual process of government. The term domestic emergency includes any or all of the emergency conditions defined below: **a. civil defense emergency** — A domestic emergency disaster situation resulting from devastation created by an enemy attack and requiring emergency operations during and following that attack. It may be proclaimed by appropriate authority in anticipation of an attack. **b. civil disturbances** — Riots, acts of violence, insurrections, unlawful obstructions or assemblages, or other disorders prejudicial to public law and order. The term civil disturbance includes all domestic conditions requiring or likely to require the use of Federal Armed Forces pursuant to the provisions of Chapter 15 of Title 10, United States Code. **c. major disaster** — Any flood, fire, hurricane, tornado, earthquake, or other catastrophe which, in the determination of the President, is or threatens to be of sufficient severity and magnitude to warrant disaster assistance by the Federal Government under Public Law 606, 91st Congress (42 United States Code 58) to supplement the efforts and available resources of State and local governments in alleviating the damage, hardship, or suffering caused thereby. **d. natural disaster** — All domestic emergencies except those created as a result of enemy attack or civil disturbance. See FM 100-20.

dominant terrain — Terrain that because of its elevation, proportions, or location, commands a view of, and may offer fields of fire over, surrounding terrain. (See also critical point and key terrain.) See FM 34-130.

dominant user concept (JP 1-02) — The concept that the Service which is the principal consumer will have the responsibility for performance of a support workload for all using Services. See FM 10-1.

dose rate — The amount of ionizing or nuclear radiation that an individual would receive during a unit of time. It is usually expressed in centigray (cGy) per hour. Dose rate is commonly used to indicate the level of radioactivity in a contaminated area. See FM 3-3-1.

dose rate contour line (JP 1-02, NATO) — A line on a map, diagram, or overlay joining all points at which the radiation dose rate at a given time is the same. See FM 3-3-1. **3-36**

double envelopment (Army) — A choice of maneuver executed by forces that move around both flanks of an enemy position to attack the flanks or objectives in the rear of the enemy. The enemy normally is fixed in position by a supporting frontal attack or by indirect or aerial fires. (See also choices of maneuver, envelopment, and turning movement.) See FMs 7-30, 71-100, 71-123, 100-5, and 100-15.

doubtful (JP 1-02) — In artillery and naval gunfire support, a term used by an observer or spotter to indicate that he was unable to determine the difference in range between the target and a round or rounds. (Army) — Includes mortars and direct fire. See FMs 6-20, 7-90, 7-91, 17-12, and 23-1.

down (JP 1-02, NATO) — In artillery and naval gunfire support: **1.** A term used in a call for fire to indicate that the target is at a lower altitude than the reference point used in identifying the target. **2.** A correction used by an observer/spotter to indicate that a decrease in height of burst is desired. (Army) — Includes mortars and direct fire. See FMs 6-20, 7-90, 7-91, 17-12, and 23-1.

downed aircrew pickup point — A point to where aviators will attempt to evade and escape to be recovered by friendly forces. See FM 1-111. **3-5**

downwind hazard area — The area downwind of a nuclear, biological, or chemical attack that may present a hazard to unprotected troops. See FM 3-3 and 3-3-1.

downwind hazard prediction — A prediction of the possible extent of chemical hazard prepared by a corps or division nuclear, biological, chemical center (NBCC) following an attack. See FM 3-3.

drop(JP 1-02, NATO) — In artillery and naval gunfire support, a correction used by an observer/spotter to indicate that a decrease in range along a spotting line is desired. (Army) — Parachute jump, individual or in mass, or supply delivery by parachute from an aircraft in flight, or the act of making such a jump or delivery. See FMs 6-20, 7-90, 23-1, 71-100-2, and 90-26.

drop zone (DZ) (JP 1-02, NATO) — A specific area upon which airborne troops, equipment, or supplies are airdropped. (See also airborne operation and drop.) See FMs 7-8, 7-20, 7-30, 71-100, and 90-26.

3-12

dual-firing circuit (JP 1-02) — An assembly comprising two independent firing systems, both electric or both non-electric, so that the firing of either system will detonate all charges. (See also demolition and state of readiness.) See FMs 5-71-100 and 5-100.

dummy minefield (JP 1-02, NATO) — In naval mine warfare, a minefield containing no live mines and presenting only a psychological threat. (Army). It is also known as a phoney minefield. (See also deception operation.) See FMs 5-100 and 90-2. **3-7**

E

early warning (JP 1-02, NATO) — Early notification of the launch or approach of unknown weapons or weapon carriers. (See also air defense.) See FMs 34-2 and 44-100.

echelon (JP 1-02, NATO) — **1.** A subdivision of a headquarters, i.e., forward echelon, rear echelon. **2.** Separate level of command. As compared to a regiment, a division is a higher echelon; a battalion is a lower echelon. **3.** A fraction of a command in the direction of depth to which a principal combat mission is assigned, i.e., attack echelon, support echelon, reserve echelon. **4.** A formation in which its subdivisions are placed one behind another, with a lateral and even spacing to the same side. (See also airborne operation, command post (CP), and formation.) See FMs 7-7, 7-8, 7-10, 7-20, 7-30, 10-1, 17-95, 71-123, 100-5, 100-10, and 100-15.

echeloned displacement (JP 1-02, NATO) — Movement of a unit from one position to another without discontinuing performance of its primary function. (DOD) Normally, the unit divides into two functional elements (base and advance); and, while the base continues to operate, the advance element displaces to a new site where, after it becomes operational, it is joined by the base element. (Army) — A movement with one element as the base of fire which covers the moving unit's movement to the next position, it is used in both offensive and defensive operations. (See also bound, bounding overwatch, defend, delaying operation, and force projection.) See FMs 6-20 series, 7-7, 7-8, 7-20, 7-30, 17-95, 71-123, 71-100, and 100-15.

echelon formation — A unit formation with subordinate elements arranged on an angle to the left of the direction of attack or to the right (echelon left; echelon right). This formation provides for firepower forward and to the flank of the direction of the echelon. It facilitates control in open areas. It provides minimal security to the opposite flank of the direction of the echeloning. (See also box formation, column formation, diamond formation, formation, line formation, movement formation, vee formation, and wedge formation.) See FMs 7-7, 7-8, and 7-20.

OPERATIONAL TERMS AND GRAPHICS

- echeloning** — The organizing and prioritizing of units for movement. Echelons are often divided into elements such as advance parties, initial combat forces, follow-on forces, and closure forces. See FM 71-100.
- echelonment** — Organization of elements within a force into three echelons—the assault echelon, the follow-on echelon, and the rear echelon. (See also airborne, assault echelon, follow-on echelon, and rear echelon.) See FMs 7-7, 7-8, 7-10, 7-20, 7-30, 17-95, 71-100, 71-100-2, 71-123, 90-26, and 100-15.
- echelons above corps (EAC) (Army)** — Army headquarters and organizations that provide the interface between the theater commander (joint or multinational) and the corps for operational matters. See FM 100-5.
- economy of force** — The allocation of minimum-essential combat capability or strength to secondary efforts so that forces may be concentrated in the area where a decision is sought. Economy of force is a principle of war and a condition of tactical operations. It is not used to describe a mission. (See also main effort.) See FMs 7-30, 17-95, 71-100, 71-123, 100-5, and 100-15.
- effective downwind message** — A message that forecasts wind speed and direction at heights corresponding to preselected nuclear weapon yields. See FM 3-3.
- egress route** — The route used to exit enemy territory after the conclusion of a mission such as a deep attack or raid. See FMs 1-111, 7-7, 7-8, 7-10, 7-20, 7-30, 17-95, 71-100, 71-123, 100-15, and 100-103.
- electromagnetic deception (JP 1-02)** — The deliberate radiation, reradiation, alteration, suppression, absorption, denial, enhancement, or reflection of electromagnetic energy in a manner intended to convey misleading information to an enemy or to enemy electromagnetic-dependent weapons, thereby degrading or neutralizing the enemy's combat capability. Among the types of electromagnetic deception are imitative, manipulative, and simulative. (See also electronic warfare (EW), information warfare (IW), imitative electromagnetic deception (IED), manipulative electromagnetic deception (MED), and simulative electromagnetic deception.) See FMs 34-1 and 34-40.
- electromagnetic interference (EMI) (JP 1-02)** — Any electromagnetic disturbance that interrupts, obstructs, or otherwise degrades or limits the effective performance of electronics/electrical equipment. It can be induced intentionally, as in some forms of electronic warfare, or unintentionally, as a result of spurious emissions and responses, intermodulation products, and the like. (See also jamming.) See FM 34-1.
- electromagnetic pulse (EMP) (JP 1-02)** — The electromagnetic radiation from a nuclear explosion caused by Compton-recoil electrons and photoelectrons from photons scattered in the materials of the nuclear device or in a surrounding medium. The resulting electric and magnetic fields may couple with electrical/electronic systems to produce damaging current and voltage surges. (Army) — The high-energy, short-duration pulse (similar in some respects to a bolt of lightning) generated by a nuclear or nonnuclear detonation. It can induce a current in any electrical conductor and can temporarily disrupt or overload and damage components of improperly protected or unprotected electronic equipment. See FM 3-3-1.
- electromagnetic radiation (JP 1-02)** — Radiation made up of oscillating electric and magnetic fields and propagated with the speed of light. Includes gamma radiation; X-rays; ultraviolet, visible, and infrared radiation; and radar and radio waves. See FM 34-40.
- electronic attack (EA) (JP 1-02)** — That division of electronic warfare involving the use of electromagnetic, directed energy, or antiradiation weapons to attack personnel, facilities, or equipment with the intent of degrading, neutralizing, or destroying enemy combat capability. EA includes: **1.** actions taken to prevent or reduce an enemy's effective use of the electromagnetic spectrum, such as jamming and electromagnetic

deception, and 2. employment of weapons that use either electromagnetic or directed energy as their primary destructive mechanism (lasers, radio frequency weapons, particle beams), or antiradiation weapons. (See also command and control warfare (C²W) and electronic warfare (EW).) See FMs 34-1 and 34-40.

electronic protection (EP) (JP 1-02) — That division of electronic warfare involving actions taken to protect personnel, facilities, and equipment from any effects of friendly or enemy employment of electronic warfare that degrade, neutralize, or destroy friendly combat capability. (See also electronic warfare (EW).) See FMs 34-1 and 34-40.

electronic intelligence (ELINT) (JP 1-02) — Technical and geolocation intelligence derived from foreign noncommunications electromagnetic radiations emanating from other than nuclear detonations or radioactive sources. (See also signals intelligence (SIGINT).) See FMs 34-1 and 34-40.

electronic warfare (EW) (JP 1-02) — Any military action involving the use of electromagnetic and directed energy to control the electromagnetic spectrum or to attack the enemy. The three major subdivisions within electronic warfare are: electronic attack, electronic protection, and electronic warfare support. (Army) — The use of electromagnetic energy to determine, exploit, reduce, or prevent hostile use of the electromagnetic spectrum and to ensure friendly use thereof. (See also command and control warfare (C²W) and deception.) See FMs 34-1 and 34-40.

electronic warfare support (ES) (JP 1-02) — That division of electronic warfare involving actions tasked by, or under direct control of, an operational commander to search for, intercept, identify, and locate sources of intentional and unintentional radiated electromagnetic energy for the purpose of immediate threat recognition. Thus, electronic warfare support provides information required for immediate decisions involving electronic warfare operations and other tactical actions such as threat avoidance, targeting, and homing. Electronic warfare support data can be used to produce signals intelligence (SIGINT), communications intelligence (COMINT), and electronics intelligence (ELINT). (See also electronic warfare (EW).) See FMs 34-1 and 34-40.

embarkation (JP 1-02, NATO) — The process of putting personnel and/or vehicles and their associated stores and equipment into ships and/or aircraft. (See also aerial port of embarkation (APOE) and amphibious operation.) See FMs 20-12 and 55-12.

embarkation order (JP 1-02, NATO) — An order specifying dates, times, routes, loading diagrams, and methods of movement to shipside or aircraft for troops and their equipment. (See also movement table and operation order (OPORD).) See FM 101-5.

emergency procedure — A mandatory procedure that a flight crew must perform to preclude loss of life or injury and to avoid damage to the aircraft when an aircraft malfunction occurs. See FMs 1-111, 1-112, 1-116, and 100-103.

emergency resupply (JP 1-02) — A resupply mission that occurs based on a predetermined set of circumstances and time interval should radio contact not be established or, once established, is lost between a special operations tactical element and its base (See also automatic resupply and on-call resupply.)

emergency risk (nuclear) (JP 1-02) — A degree of risk where anticipated effects may cause some temporary shock and casualties and may significantly reduce the unit's combat efficiency. (Army) — Emergency risk is accepted only when absolutely necessary. It includes vulnerability categories expressed in terms of risk to unwarned, exposed personnel; exposed personnel; warned, protected personnel. (See also

OPERATIONAL TERMS AND GRAPHICS

degree of risk (nuclear), moderate risk (nuclear), negligible risk (nuclear), and troop safety (nuclear).) See FM 100-30 and JPs 3-12.2 and 3-12.3.

emplacement (JP 1-02, NATO) — **1.** A prepared position for one or more weapons or pieces of equipment, for protection against hostile fire or bombardment, and from which they can execute their tasks. **2.** The act of fixing a gun in a prepared position from which it may be fired. (See also defend.) See FMs 5-103, 6-20 series, 7-7, 7-8, 7-90, and 71-123. **3-33**

encirclement— The loss of freedom of maneuver to one force resulting from an enemy force's control of all routes of egress and reinforcement. (See also breakout and linkup.) See FMs 6-20, 7-20, 7-30, 17-95, 71-100, 71-123, and 100-5. **3-19**

encircling force — In pursuit operations, the force which is to get to the rear of the enemy and block his escape so that he can be destroyed between the direct pressure and encircling force. This force advances or flies along routes paralleling the enemy's line of retreat. This force may also attack into the flank of a retreating enemy. (See also block, envelopment, and pursuit.) See FMs 1-111, 1-112, 7-10, 7-20, 7-30, 17-95, 71-100, 100-5, and 100-15.

end evening civil twilight (EECT) — Occurs when the sun has dropped 6 degrees beneath the western horizon and is the instant at which there is no longer sufficient light to see objects with the unaided eye. Light intensification devices are recommended from this time until begin morning civil twilight (BMCT). (See also limited-visibility operations and twilight.)

end evening nautical twilight (EENT) — Occurs when the sun has dropped 12 degrees beneath the western horizon and is the instant of last available daylight. At the EENT, there is no further sunlight visible. (See limited-visibility operations and twilight.)

end of mission (JP 1-02, NATO) — In artillery and naval gunfire support, an order given to terminate firing on a specific target. (Army) — Pertains to mortar fire also. (See also cease loading, call for fire, and fire mission.) See FMs 6-20 series and 7-90.

end state (Army) — A set of required conditions that, when achieved, attain the aims set for the campaign or operation. (See also battlefield visualization, commander's intent, and operation order (OPORD).) See FMs 71-100, 100-5, and 100-15.

enemy— The individual, group of individuals (organized or not organized), paramilitary or military force, national entity, or national alliance that is in opposition to the United States, its allies, or multinational partners. **Ch 4** **App B** **D-2 to D-8**

enemy prisoner of war (EPW) — Enemy personnel captured during operations conducted in war or combat, or stability and support operations. See FMs 19-40 and 27-10. **3-38**

enfilading fire — A type of engagement where the beaten zone of the firing weapon is on the long axis of the target being engaged. This usually occurs from the flank of the target. See FMs 7-7, 7-8 and 7-10.

engage (JP 1-02, NATO) — In air defense, a fire control order used to direct or authorize units and/or weapon systems to fire on a designated target. (See also cease fire.)

engagement (JP 1-02) — In air defense, an attack with guns or air-to-air missiles by an interceptor aircraft, or the launch of an air defense missile by air defense artillery and the missile's subsequent travel to

intercept. (Army) — A small tactical conflict, usually between opposing maneuver forces. (See also battle and campaign.) See FMs 1-112, 7-7, 7-8, 7-10, 7-20, 7-30, 17-95, 44-100, 71-123, 100-5, and 100-15.

engagement area (EA) — An area along an enemy avenue of approach where the commander intends to contain and destroy an enemy force with the massed fires of all available weapons. The size and shape of the engagement area is determined by the relatively unobstructed intervisibility from the weapon systems in their firing positions and the maximum range of those weapons. Sectors of fire are usually assigned to subordinates to prevent fratricide. (See also defend.) See FMs 1-111, 1-112, 7-10, 7-20, 7-30, 17-95, 71-100, 71-123, 100-5, and 100-15. **3-8, 3-12**

engagement criteria — Those circumstances that allow engagement of an enemy force without a specific command to do so. Examples are a point or line on the ground that an enemy crosses or an event or action that an enemy does. (See also engagement area (EA) and decision point (DP).) See FMs 6-series, 7-7, 7-8, 7-10, 7-20, 7-90, 7-91, 17-12, 17-95, 23-1, 71-123, and 101-5.

engagement priorities — The sequence for attack of targets in order of importance assigned to specific weapon systems to facilitate the destruction of threat vehicles expected in an armored formation. Engagement priorities are assigned based on the type or level of threat at different ranges to best match organic weapon system capabilities against threat vulnerabilities. See FM 101-5.

engineer regulating point (ERP) — Checkpoint to ensure that vehicles do not exceed the capacity of the crossing means and to give drivers final instructions on site-specific procedures and information, such as speed and vehicle interval. See FMs 5-71-100, 5-100, and 5-114. **3-28**

engineer work line — A coordinated boundary or phase line used to compartmentalize an operational area to indicate where specific engineer units have primary responsibility for the engineer effort. It may be used at division level to discriminate between a sector supported by division engineer assets and a sector supported by direct support or general support corps engineer units. See FMs 5-71-100, 5-100, and 5-114.

envelopment (JP 1-02, NATO) — An offensive maneuver in which the main attacking force passes around or over the enemy's principal defensive positions to secure objectives to the enemy's rear. (Army) — It is one of the five choices of maneuver. A commander must find or create an assailable flank by passing forces around one or both of, or over (vertical), the sides of an enemy force, pitting his strength against the enemy's weakness. (See also attack, choices of maneuver, double envelopment, encircling force, offensive operations, and turning movement.) See FMs 1-111, 1-112, 7-20, 7-30, 17-95, 71-100, 71-123, 100-5, and 100-15.

environmental area of interest — An environmentally sensitive area that may be deemed worthy of special consideration because of its unique and important qualities relative to adjacent areas (for example, the only forest within a large region), or the importance of its natural environmental function (for example, a wetland, flood plains, permafrost area, or an endangered species critical habitat). The environmental area of interests includes man-made structures such as waste water treatment plants and dams.

environmental base line survey — An assessment, or study, done on an area of interest (a property) in order to define the environmental state or condition of that property prior to use by US forces. Used to determine the environmental impact of property use by US forces, and the level of environmental restoration needed prior to returning the property, upon US departure.

OPERATIONAL TERMS AND GRAPHICS

environmental compliance — The unconditional obeying of international, foreign nation, federal, state, and local environmental rules, regulations, and guidelines that affect current operations.

environmental conditions report (ECR) — A concise summary of environmental conditions at a base camp site, based on the environmental base line survey, supported by maps and backup documents, prepared by base camp commanders for each base camp. The ECR documents conditions at the site if claims or other legal challenges arise against the government.

environmental protection — The application of human ingenuity and resources, through the disciplines of science and engineering, as required by environmental protection laws, regulations, and policies, to protect the natural environment.

environmental protection level — The varying level of environmental protection that can reasonably be afforded at any particular time during warfare, or battlefield conditions, given the absolute requirement that such a diversion of resources away from the mission at hand does not adversely affect that mission, or any friendly personnel, or indigenous or refugee populations.

environmental reconnaissance — The systematic observation and recording of site or area data collected by visual or physical means, dealing specifically with environmental conditions as they exist, and identifying areas that are environmentally sensitive or of relative environmental concern, for information and decision-making purposes.

escort (JP 1-02, NATO) — **1.** A combatant unit(s) assigned to accompany and protect another force or convoy. **2.** Aircraft assigned to protect other aircraft during a mission. **3.** An armed guard that accompanies a convoy, a train, prisoners, etc. **4.** An armed guard accompanying persons as a mark of honor. (DOD) **5.** To convoy. **6.** A member of the Armed Forces assigned to accompany, assist, or guide an individual or group, e.g., an escort officer. See FMs 1-111, 1-112, 7-30, 17-95, 71-100, 71-123, 100-5, 100-15, and 100-20.

essential elements of friendly information (EEFI) (JP 1-02) — Key questions likely to be asked by adversary officials and intelligence systems about specific friendly intentions, capabilities, and activities so they can obtain answers critical to their operational effectiveness. (Army) — The critical aspects of a friendly operation that, if known by the enemy, would subsequently compromise, lead to failure, or limit success of the operation, and therefore must be protected from enemy detection. (See also commander's critical information requirements (CCIR).) See FMs 34-1 and 101-5.

essential elements of information (EEI) (JP 1-02) — The critical items of information regarding the enemy and the environment needed by the commander by a particular time to relate with other available information and intelligence in order to assist in reaching a logical decision. (Army) — Within US Army doctrine, priority intelligence requirements equate to EEI. (See also commander's critical information requirements. (CCIR).) See FM 101-5.

evacuation (JP 1-02) — **1.** The process of moving any person who is wounded, injured, or ill to and/or between medical treatment facilities. **2.** The clearance of personnel, animals, or materiel from a given locality. **3.** The controlled process of collecting, classifying, and shipping unserviceable or abandoned material, United States and foreign, to appropriate reclamation, maintenance, technical intelligence, or disposal facilities. (Army) — **1.** The ordered or authorized departure of noncombatants from a specific area by the Department of State, Department of Defense, or appropriate military commander. This refers to the movement from one area to another in the same or different countries. The evacuation is caused by unusual or emergency circumstances and applies equally to command or noncommand-sponsored family members. **2.** A combat service support function that involves the movement of recovered material, personnel, casualties, bodies, prisoners of war, and so forth, from a forward collection point

along a main supply route to a rearward, usually higher unit, exchange point, or facility. (See also collection point and medical evacuation (MEDEVAC).) See FMs 1-111, 1-112, 7-10, 7-20, 7-30, 8-10-6, 17-95, 17-100, 71-123, 100-5, and 100-15.

evacuation force — In noncombatant evacuation operations, the element that conducts in-country evacuation operations, including advance party, evacuation control center, marshalling, and force protection operations. (See also evacuation.) See FM 90-29.

evacuation site — In noncombatant evacuation operations, the location, selected by the embassy and occupied by the evacuation force, where evacuees are consolidated and prepared for evacuation. It is usually located near the point of embarkation. (See also evacuation.) See FM 90-29.

evasion and escape (E&E) (JP 1-02, NATO) — The procedures and operations whereby military personnel and other selected individuals are enabled to emerge from an enemy-held or hostile area to areas under friendly control. See FMs 1-111 and 100-25.

event template — A model against which enemy activity can be recorded and compared. It represents a sequential projection of events that relate to space and time on the battlefield and indicate the enemy's ability to adopt a particular course of action. The event template is a guide for collection and reconnaissance and surveillance planning. (See also decision support template, doctrinal template, named area of interest (AI), and situation template.) See FMs 34-1 and 34-130.

exclusive standoff zone (Army) — A controlled area surrounding a facility in which only service and delivery vehicles are allowed. The perimeter of this area is defined by barriers and is set at a standoff distance sufficient to reduce the blast effects of a vehicle bomb. See FMs 5-114 and 100-20.

execution matrix — A visual and sequential representation of the critical tasks and responsible organizations by phase for a tactical operation used as a staff tool. See FMs 71-123 and 101-5.

exercise (JP 1-02, NATO) — A military maneuver or simulated wartime operation involving planning, preparation, and execution. It is carried out for the purpose of training and evaluation. It may be a combined, joint, or single-Service exercise, depending on participating organizations. (See also command post exercise (CPX) and maneuver.) See FMs 25-100 and 25-101.

exfiltration(JP 1-02) — The removal of personnel or units from areas under enemy control. (Army) — The removal of personnel or units from areas under enemy control by stealth, deception, surprise, or clandestine means. See FMs 1-111, 1-112, 7-7, 7-8, 7-10, 7-20, 7-30, 17-95, 71-100, 71-123, 100-5, and 100-15.

expedient flight route — Flight route that is established with preselected and disseminated checkpoints. For a specific mission, the commander can define an expedient flight route by reference to these checkpoints when limited time is available to develop and disseminate pickup and landing zones and flight route information. See FMs 1-111, 1-112, 1-116, 90-4, and 100-103.

expeditionary force (JP 1-02) — An armed force organized to accomplish a specific objective in a foreign country. (See also combatant command and joint task force (JTF).) See FMs 71-100, 100-5, 100-15, and 100-20.

exploitation (JP 1-02, NATO) — **1.** Taking full advantage of success in battle and following up initial gains. **2.** Taking full advantage of any information that has come to hand for tactical, operational, or strategic purposes. **3.** An offensive operation that usually follows a successful attack and is designed to disorganize the enemy in depth. (See also attack and pursuit.) See FMs 1-111, 1-112, 7-7, 7-8, 7-10, 7-20, 7-30, 17-95, 17-123, 71-100, 100-5, and 100-15.

OPERATIONAL TERMS AND GRAPHICS

explosive ordnance disposal (EOD) (JP 1-02, NATO) — The detection, identification, on-site evaluation, rendering safe, recovery, and final disposal of unexploded explosive ordnance. It may also include explosive ordnance which has become hazardous by damage or deterioration. See FM 5-250.

exposure — The frequency and length of time subjected to a hazard.

exposure dose (JP 1-02, NATO) — The exposure dose at a given point is a measurement of radiation in relation to its ability to produce ionization. The unit of measurement of the exposure dose is the roentgen. (See also absorbed dose and dose rate.) See FM 3-3-1.

external load — A person, piece of equipment, or pallet or package of supplies transported by being suspended externally to a helicopter by a lifting service consisting of a combination of a cargo hook or hooks, an external hoist, or a sling apparatus. See FMs 55-450-3/ 4/5.

extraction zone (EZ) (JP 1-02, NATO) — A specified drop zone used for the delivery of supplies and/or equipment by means of an extraction technique from an aircraft flying very close to the ground. (See also air assault, airborne operation, and airhead line.) See FMs 7-30, 71-100-2, and JP 3-18.1. **3-12**

F

faker (JP 1-02) — A friendly aircraft simulating a hostile in an air defense exercise. (See also air defense.) See FM 44-100.

fallout (JP 1-02, NATO) — The precipitation to Earth of radioactive particulate matter from a nuclear cloud; also applied to the particulate matter itself. (See also downwind hazard area, radiation dose, radiation dose rate, and radiation status (RS).) See FM 3-3-1.

family of scatterable mine (FASCAM) — A grouping of munitions that dispense scatterable mines (scatmines) by artillery, helicopter, fixed wing, or ground launchers. There are antipersonnel and antitank mines. All US scatmines self-destruct at preset times. The self-destruct times depend on the type of munition. (See also minefield and scatterable mines.) See FMs 5-71-100, 6-series, and 20-32. **3-30**

fascines — Large cylindrical bundles of material, usually wooden poles or plastic or metal pipe loosely bound together, which are dropped into ditches or gaps to create crossings. (See also block and obstacle.) See FM 5-102.

feint (Army) — A type of attack used as a deception intended to draw the enemy's attention away from the area of the main attack. This induces the enemy to move his reserves or to shift his fire support in reaction to the feint. Feints must appear real and therefore require some contact with the enemy. Usually a limited-objective attack ranging in size from a raid to a supporting attack is conducted. (See also attack, deception, demonstration, display and ruse.) See FMs 6-20, 7-30, 17-95, 71-100, 71-123, 90-2, 100-5 and 100-15. **3-7**

field exercise (JP 1-02, NATO) — An exercise conducted in the field under simulated war conditions in which troops and armament of one side are actually present, while those of the other side may be imaginary or in outline. (See also command post exercise (CPX).) See FMs 25-100, 25-101, and 101-5.

field of fire (JP 1-02, NATO) — The area which a weapon or a group of weapons may cover effectively with fire from a given position. (See also intelligence preparation of the battlefield (IPB), enfilading fire, battle position (BP), and dead space.) See FMs 7-7, 7-8, and 7-10.

field fortifications (JP 1-02, NATO) — An emplacement or shelter of a temporary nature which can be constructed with reasonable facility by units requiring no more than minor engineer supervisory and equipment participation. (See also battle position (BP), emplacement, and strongpoint (SP).) See FM 5-103. **3-12, 3-33**

field services — Essential services to enhance a soldier's quality of life during operations. They include food preparation, water purification, mortuary affairs support, airdrop support, laundry and shower services, and cloth and light textile repair. See FM 10-1.

field trains — The combat service support portion of a unit at company, battalion, and brigade level that is positioned in the brigade support area with the forward support battalion and other support elements pushed forward from the division main support battalion. At company level, supply and mess teams normally will be located in the battalion field trains. A battalion's field trains may include mess teams and the portion of the supply section of the support platoon, a maintenance element, and ammunition and petroleum, oils, and lubricants (POL) elements not forward in the combat trains. (See also combat trains and unit trains.) See FMs 7-30, 7-123, 63-2, and 63-20. **4-23**

field trains command post (FTCP) (Army) — At the battalion and squadron levels, the place from which the HHC/HHT commander controls the field trains operations. See FMs 7-7, 7-8, and 7-20. **A-3**

fighter liaison officer (FLO) (Army) — A member of the tactical air control party. He is responsible to the corps air liaison officer (ALO) and provides specific knowledge and expertise on the employment of fighter attack aircraft.

final coordination line (FCL) — A line close to the enemy position used to coordinate the lifting or shifting of supporting fires with the final deployment of maneuver elements. It should be recognizable on the ground. It is not a fire support coordination measure. (See also assault.) See FMs 7-7, 7-8, 7-10, 7-20, 7-30, and 71-123. **3-16**

final protective fire (FPF) (JP 1-02, NATO) — An immediately available prearranged barrier of fire designed to impede enemy movement across defensive lines or areas. (See also battle position (BP), defend, and final protective line (FPL).) See FMs 7-7, 7-8, 7-10, 7-20, 7-30, and 71-123. **3-23**

final protective line (FPL) — A line of fire selected where an enemy assault is to be checked by interlocking fire from all available weapons and obstacles. (See also dead space, field of fire, final protective fire (FPF), and principal direction of fire (PDF).) See FMs 6-20 series, 7-7, 7-8, 7-10, 7-20, 7-30, and 71-123.

fire (JP 1-02, NATO) — **1.** The command given to discharge a weapon(s). **2.** To detonate the main explosive charge by means of a firing system. (Army) — **1.** The act of discharging a weapon(s), launching rockets and missiles, or detonating an explosive. **2.** The receiving of the effects of weapon(s) ammunition and explosions.

fire base (FB) — **1.** An area used during air assault operations from which a unit is moved via helicopter and supports the air assault operation's main effort with direct or indirect fires. **2.** An area in hostile or insurgent territory which has a 360-degree defense and which supports combat patrols or larger operations with combat support and combat service support assets. (See also echelonment.) See FM 71-100-3.

OPERATIONAL TERMS AND GRAPHICS

fire command — A specific sequence of information given by a control authority (for example, a vehicle commander or fire direction center) that causes a crew to begin performing a sequence of actions and provides detailed direction to choose the ammunition type, aim the weapon, and engage the target. Each element given by the controller requires a response from a crew member to ensure correct aiming and engagement. After the initial fire command, subsequent fire commands using the same sequence of information can be used to adjust the point of impact to ensure the desired target effect. See Fms 6-series, 7-90, 7-91, 17-12, and 23-1.

fire direction center (FDC) (JP 1-02, NATO) — That element of a command post, consisting of gunnery and communication personnel and equipment, by means of which the commander exercises fire direction and/or fire control. The fire direction center receives target intelligence and requests for fire, and translates them into appropriate fire direction. (Army) — Provides timely and effective tactical and technical fire control in support of current operations. See FMs 6-20 series and 7-90.

fire for effect (JP 1-02, NATO) — **1.** Fire which is delivered after the mean point of impact or burst is within the desired distance of the target or adjusting/ranging point. **2.** Term in a call for fire to indicate the adjustment/ranging is satisfactory and fire for effect is desired. (Army) — That volume of fires delivered on a target to achieve the desired effect. (See also destroy, final protective fire (FPF), fire mission, neutralize, and suppression.) See FMs 7-7, 7-8, 7-10, 7-20, 7-30 and 71-123.

fire mission (JP 1-02, NATO) — **1.** Specific assignment given to a fire unit as part of a definite plan. **2.** Order used to alert the weapon/battery area and indicate that the message following is a call for fire. (See also call for fire, cease loading, and fire support element (FSE)) See FMs 6-20 series and 7-90.

fire and movement — The concept of applying fires from all sources to suppress, neutralize, or destroy the enemy, and the tactical movement of combat forces in relation to the enemy (as components of maneuver is applicable at all echelons). At the squad level, it entails a team placing suppressive fire on the enemy as another team moves against or around the enemy. (See also bounding overwatch, formation, movement technique, and support by fire.) See FMs 7-7, 7-8, 7-10, 7-20, 7-30, and 71-123.

fire plan (JP 1-02, NATO) — A tactical plan for using the weapons of a unit or formation so that their fire will be coordinated. (See also offensive operations, defend, air defense, fire support, and final protective fire (FPF).) See FMs 6-20 series, 7-7, 7-8, 7-10, 7-20, 7-30, and 71-123.

firepower(JP 1-02, NATO) — **1.** The amount of fire which may be delivered by a position, unit, or weapon system. **2.** Ability to deliver fire. (Army) — The potential capacity (product) of all weapons and attack systems available to the force commander. (See also combat power; fire plan; and mission, enemy, terrain, troops, and time available (METT-T).) See FMs 1-113, 6-20, 7-10, 7-20, 7-30, 17-95, 71-100, 71-123, 100-5, and 100-15.

fires — The delivery of all types of ordnance through both direct and indirect means, as well as nonlethal means, that contribute to the destruction, disruption, or suppression of the enemy; facilitate tactical movement; and achieve a decisive impact. See FMs 6-20 series, 7-20, 7-30, 17-95, 71-100, 71-123, 100-5, and 100-15.

fire support — The collective and coordinated integration and synchronization of the fires and effects of armed aircraft, land-based and sea-based indirect fire systems, and electronic warfare systems that directly support combat forces against ground targets to delay, disrupt, destroy, divert, damage, and limit enemy forces, combat formations, and facilities in pursuit of operational and tactical objectives. (See also combined arms and fire support plan.) See FMs 6-20 series, 7-20, 7-30, 17-95, 71-100, 100-5, and 100-15.

fire support area (FSA) (Army) — A sea area in which a ship may position or cruise while firing in support of ground forces. (See also fire support station (FSS) and naval gunfire support (NGFS).) See FM 6-series. **3-23**

fire support coordinating measure (JP 1-02) — A measure employed by land or amphibious commanders to facilitate the rapid engagement of targets and simultaneously provide safeguards for friendly forces. (Army) — In close coordination with supporting air asset commanders. (See also fire support coordination.) See FMs 6-20 series, 7-20, 7-30, 17-95, 71-100, 71-123, 100-5, and 100-15.

fire support coordination (JP 1-02, NATO) — The planning and executing of fire so that targets are adequately covered by a suitable weapon or group of weapons. (See also fire support coordinating measure.) See FMs 6-20 series, 7-20, 7-30, 17-95, 71-100, 71-123, 100-5, and 100-15.

fire support coordination line (FSCL) (JP 1-02) — A line established by the appropriate land or amphibious force commander to ensure coordination of fire not under the commander's control but which may affect current tactical operations. The FSCL is used to coordinate fires of air, ground, or sea weapons systems using any type of ammunition against surface targets. The FSCL should follow well-defined terrain features. The establishment of the FSCL must be coordinated with the appropriate tactical air commander and other supporting elements. Supporting elements may attack targets forward of the FSCL without prior coordination with the land or amphibious force commander provided the attack will not produce adverse surface effects on or to the rear of the line. Attacks against surface targets behind this line must be coordinated with the appropriate land or amphibious force commander. (Army) — A permissive fire control measure established and adjusted by the ground commander in consultation with superior, subordinate, supporting, and other affected commanders. It is not a boundary; synchronization of operations on either side of the FSCL is the responsibility of the establishing commander out to the limits of the land component forward boundary. It applies to all fires of air, land, and sea weapon systems using any type of ammunition against surface targets. Forces attacking targets beyond the FSCL must inform all affected commanders to allow necessary coordination to avoid fratricide. (See also boundary, coordinated fire line (CFL), and fire support coordinating measure.) See FMs 6-20 series, 7-20, 7-30, 17-95, 71-100, 71-123, 100-5, 100-15, and JP 3-0. **3-21**

fire support element (FSE) — A functional portion of a force tactical operations center that provides centralized targeting, coordination, and integration of fires delivered on surface targets by fire support means under the control of or in support of the force. This element is staffed from the field artillery headquarters or field artillery staff section of the force and representatives of other fire support means. (See also fire support coordinating measure and fire support plan.) See FMs 6-20 series, 7-20, 7-30, 17-95, 71-100, 71-123, 100-5, and 100-15.

fire support plan — A plan on how indirect fires and target acquisition will be used to support an operation. It should include a portion for each means of fire support involved. (See also counterfire, fire support, fire support coordination, list of targets, operation order (OPORD), and target list.) See FMs 6-20 series and 101-5.

fire support station (FSS) (Army) — A specified position at sea from which a ship must fire in support of ground forces. This is very restrictive and puts the ship at greatest risk. (See also fire support area (FSA) and naval gunfire support (NGFS).) See FM 6-20 series. **3-23**

fire support team (FIST) (Army) — In fire support operations, a team comprised of a team chief (field artillery lieutenant) and the necessary additional personnel and equipment required to plan, request, coordinate, and direct fire support efforts for company-sized units. (See also fire support element (FSE).) See FMs 6-20-20 and 7-10. **4-15**

OPERATIONAL TERMS AND GRAPHICS

firing circuit (JP 1-02) — **1.** In land operations, an electrical circuit and/or pyrotechnic loop designed to detonate connected charges from a firing point. **2.** In naval mine warfare, that part of a mine circuit which either completes the detonator circuit or operates a ship counter. See FMs 5-71-100 and 5-250.

first destination reporting point (FDRP) (Army) — A point manned by a movement regulating team, a movement control team, or military police that diverts a driver and cargo to an alternate consignee or destination. See FM 55-10.

fix (JP 1-02, NATO) — A position determined from terrestrial, electronic, or astronomical data. (See also way point.) (Army) — **1.** A tactical task in which actions are taken to prevent the enemy from moving any part of his forces either from a specific location or for a specific period of time by holding or surrounding them to prevent their withdrawal for use elsewhere. **2.** A tactical obstacle effect that integrates fire planning and obstacle effort to slow an attacker within a specified area—normally an engagement area. (See also block, contain, disrupt, support by fire, and turn.) See FMs 1-112, 5-71-100, 5-102, 7-7, 7-8, 7-10, 7-20, 7-30, 17-95, 71-100, 71-123, 90-7, 100-5, and 100-15. **3-31** **C-9**

flank guard (JP 1-02, NATO) — A security element operating to the flank of a moving or stationary force to protect it from enemy ground observation, direct fire, and surprise attack. (See also screen and security operations.) See FMs 1-111, 1-112, 1-116, 7-20, 7-30, 17-95, 71-100, 71-123, and 100-5. **C-11**

flash blindness (JP 1-02, NATO) — Impairment of vision resulting from an intense flash of light. It includes temporary or permanent loss of visual functions and may be associated with retinal burns. (See also dazzle and directed-energy warfare (DEW).) See FM 100-30.

flight coordination center (FCC) (Army) — A primary Army air traffic control agency that is subordinate to the flight operations center (FOC). It provides flight following as well as information on air traffic movement within its assigned area; monitors Army aircraft operations and provides hostile activity warnings to Army aviation units operating in the airspace; passes instrument flight rules flight plans to the airspace management center for approval and visual flight rules flight plans to the appropriate air traffic services facility; establishes liaison with the air defense command post; and provides a communications link between terminal facilities of existing airfields, other nearby airfields, division command posts, other FCCs, and the FOC when the FCC locates in a division area. See FMs 1-111 and 100-103.

flight corridor — A restricted air route of travel specified for use by friendly aircraft and established to prevent friendly aircraft from being fired on by friendly forces. It is used to deconflict artillery firing positions with aviation traffic. (See also air control point (ACP), air corridor, communications checkpoint (CCP), and low-level transit route (LLTR).) See FMs 1-111, 71-100-3, and 100-103.

flight following (JP 1-02, NATO) — The task of maintaining contact with specified aircraft for the purpose of determining *en route* progress and/or flight termination. (See also air control point (ACP), air corridor, and communications checkpoint (CCP).) See FMs 1-111 and 100-103.

flight operations center (FOC) (JP 1-02) — The element of the tactical Army air traffic regulation system which provides for aircraft flight following, separation of aircraft under instrument conditions, and identification of friendly aircraft to friendly air defense agencies. (Army) — The senior Army Air Traffic Control Agency for an Army corps. It is normally collocated with the USAF Control and Reporting Center (CRC). As a minimum, the CRC and FOC are electronically connected. The FOC locates in the corps area of operations; conducts flight following, and supervises the operations of the flight coordination center, but is primarily an information center. See FM 1-111.

float — Logistics support that provides major assembly replacement for a piece of equipment which is repairable but will take an extraordinary amount of time to repair.

follow — A term used to broadly define the order of movement of committed or uncommitted combat, combat support, and combat service support forces in a given combat operation. The term is a tactical task in which maneuver control measures must be used.

follow and assume — An operation in which a committed force follows a force conducting an offensive operation and is prepared to continue the mission of the force it is following when that force is fixed, attrited, or otherwise unable to continue. Such a force is not a reserve but is committed to accomplish specified tasks. (See also attack and offensive operations.) See FMs 7-20, 7-30, 17-95, 71-100, 71-123, 100-5, and 100-15. **C-9**

follow-on echelon — Forces moved into the objective area by air or surface after the assault echelon of an airborne, air assault, or amphibious operation to sustain the defense and to conduct offensive operations as part of the larger force after linkup. Normally, it includes follow-on elements of the maintenance unit, headquarters elements, and elements of the supply and service battalion. (See also air assault, assault echelon, and rear echelon.) See FMs 1-111, 7-20, 7-30, 71-100-2, 71-100-3, 90-4, and 90-26.

follow and support — An operation in which a committed force follows and supports the mission accomplishment of a force conducting an offensive operation. Such a force is not a reserve but is committed to accomplish any or all of these tasks: destroy bypassed units; relieve in place any direct pressure or encircling force that has halted to contain the enemy; block movement of enemy reinforcements; secure lines of communication; guard prisoners, key areas, and installations; secure key terrain; and control refugees. (See also direct pressure force, encircling force, exploitation, and pursuit.) See FMs 7-20, 7-30, 17-95, 71-100, 71-123, 100-5, 100-15, and 101-5. **C-9**

force projection — The movement of military forces from the continental United States (CONUS) or a theater in response to requirements of war or stability and support operations. Force-projection operations extend from mobilization and deployment of forces, to redeployment to CONUS or home theater, to subsequent mobilization. Force projection includes the following eight stages: mobilization; predeployment activity; deployment; entry operations; operations; war termination and post conflict operations; redeployment and reconstitution; and demobilization. See FMs 71-100, 100-5, 100-15, 100-20, and 100-30.

force protection (JP 1-02) — Security program designed to protect soldiers, civilian employees, family members, facilities, and equipment, in all locations and situations, accomplished through planned and integrated application of combatting terrorism, physical security, operations security, personal protective services, and supported by intelligence, counterintelligence, and other security programs. (Army) — One of the four primary elements that combine to create combat power. It conserves the fighting potential of a force. The four components of force protection are: operational security and deception operations; the soldier's health and morale; safety; and the avoidance of fratricide. (See also peace operations.) See FMs 100-5, 100-15, and 100-23.

ford — A shallow part of a body of water or wet gap that can be crossed without bridging, boats, ferries, or rafts. It is a location in a water barrier where the physical characteristics of current, bottom, and approaches permit the passage of personnel, vehicles, and other equipment where the wheels or tracks remain in contact with the bottom at all times. (See also gap, reconnaissance (recon, recce), and river crossing.) See FMs 5-100, 5-101, and 17-95. **3-28**

OPERATIONAL TERMS AND GRAPHICS

foreign internal defense (FID) (JP 1-02) — Participation by civilian and military agencies of a government in any of the action programs taken by another government to free and protect its society from subversion, lawlessness, and insurgency. See FM 100-20.

formation (JP 1-02, NATO) — **1.** An ordered arrangement of troops and/or vehicles for a specific purpose. **2.** An ordered arrangement of two or more ships, units, or aircraft proceeding together under a commander. (Army) — Types of formations include: box, column, diamond, line, vee, wedge, echelon (right or left). (See also box formation, column formation, diamond formation, echelon formation, line formation, movement technique, vee formation, and wedge formation.) See FMs 1-111, 1-112, 7-7, 7-8, 7-10, 7-20, 7-30, 17-95, 71-100, and 71-123.

form of tactical operations (Army) — A distinct tactical activity with a unique set of doctrinal characteristics, such as movement to contact or area defense. (See also choices of maneuver, tactical task, and type of operation.)

forward area — A location near an enemy or a hostile force or persons.

forward arming and refueling point (FARP) — A temporary facility that is organized, equipped, and deployed by an aviation commander, and is normally located in the main battle area closer to the area of operations than the aviation unit's combat service support area. It provides fuel and ammunition necessary for the employment of aviation maneuver units in combat. It permits combat aircraft to rapidly refuel and rearm simultaneously. See FMs 1-111, 7-30, 71-100, 100-15, and 100-103. **3-38**

forward assembly area (FAA) (Army) — A temporary area where aviation units gather to prepare for a mission that is forward of the aviation brigade's assembly area and airfield, but not as far forward as the attack position. Aircraft may be in the FAA for short or long durations based on METT-T. See FMs 1-111 and 71-100-3.

forward boundary — The farthest limit, in the direction of the enemy, of an organization's responsibility. The organization is responsible for deep operations to that limit. The next higher headquarters is responsible for coordinating deep operations beyond that limit. In offensive operations, the forward boundary may move from phase line to phase line, depending on the battlefield situation. **3-11**

forward defense — A choice of defensive maneuver where the majority of a unit's combat power is deployed in a generally linear manner along or near the forward edge of the battle area (FEBA). Security, reconnaissance, and counterreconnaissance forces are employed forward of the FEBA. The objective of this choice of maneuver is to destroy the enemy in the vicinity of the FEBA. Counterattacks forward of the defending forces are critical to this choice of maneuver. The perimeter defense is a type of forward defense. (See also choices of maneuver and defensive operations.)

forward edge of the battle area (FEBA) (JP 1-02, NATO) — The foremost limits of a series of areas in which ground combat units are deployed, excluding the areas in which the covering or screening forces are operating, designated to coordinate fire support, the positioning of forces, or the maneuver of units. (See also main battle area (MBA).) See FMs 1-111, 6-20 series, 7-20, 7-30, 71-100, 71-123, 100-5, and 100-15. **3-9**

forward line of own troops (FLOT) (JP 1-02) — A line which indicates the most forward positions of friendly forces in any kind of military operation at a specific time. The FLOT normally identifies the forward location of covering and screening forces. (Army) — The FLOT may be at, beyond, or short of the FEBA. An enemy FLOT indicates the forward most position of hostile forces. (See also line of contact (LC).) See FMs 1-111, 6-20 series, 7-20, 7-30, 71-100, 71-123, 100-5, and 100-15. **3-12**

forward logistics base (FLB) (Army) — The area occupied by multifunctional forward logistics elements of a support battalion, group, or command when it echelons its assets to provide critical support to combat forces. This base may be the first stage of the development of a support area. See FM 10-1.

forward logistics element (FLE) (Army) — A multifunctional forward logistics element task-organized to support fast-moving offensive operations, early phases of contingency operations, and units geographically separated from normal support channels. The FLE operates out of a forward logistics base. See FM 63-2-1.

forward observer (FO) (JP 1-02) — An observer operating with front line troops and trained to adjust ground or naval gunfire and pass back battlefield information. In the absence of a forward air controller, the observer may control close air support strikes. See FMs 6-20 serie and 7-10.

forward operating base (USMC) — An airfield used to support tactical operations without establishing full support facilities. The base may be used for an extended time period. Support by a main operating base will be required to provide backup support for a forward operating base. See FMFRP 0-14.

forward operations base (FOB) (JP 1-02) — In special operations, a base usually located in friendly territory or afloat that is established to extend command and control or communications or to provide support for training and tactical operations. Facilities may be established for temporary or longer duration operations and may include an airfield or an unimproved airstrip, an anchorage, or a pier. A forward operations base may be the location of special operations component headquarters or a smaller unit that is controlled and/or supported by a main operations base. (See also advanced operations base (AOB) and main operations base (MOB).) See FMs 71-100-3 and 100-25.

forward-presence units — Those US active component forces and reserve forces assigned or deployed overseas in a specific theater.

forward slope (JP 1-02, NATO) — Any slope which descends toward the enemy. See FM 21-26.

fragmentary order (FRAGO) (JP 1-02) — An abbreviated form of an operation order, usually issued on a day-to-day basis, that eliminates the need for restating information contained in a basic operation order. It may be issued in sections. (Army) — A form of operation order which contains information of immediate concern to subordinates. It is an oral, a digital, or a written message that provides brief, specific, and timely instructions without loss of clarity. It is issued after an operation order to change or modify that order or to execute a branch or sequel to that order. See FM 101-5.

fratricide — The employment of friendly weapons and munitions with the intent to kill the enemy or destroy his equipment or facilities, which results in the unforeseen or unintentional death, injury, or damage to friendly personnel or equipment. See FMs 1-111, 6-20, 7-7, 7-8, 7-10, 7-20, 7-30, 17-95, 71-100, 71-123, 100-5, 100-15, and 101-5.

free fire area (FFA) — A specific designated area into which any weapon system may fire without additional coordination with the establishing headquarters. Normally, it is established on identifiable terrain by division or higher headquarters. (See also fire support coordination and rules of engagement (ROE).) See FM 6-20 series. **3-21**

friendly (JP 1-02) — A contact positively identified as friendly. (Army) — It may be part of the same force, whether allied, joint, coalition, partisan, or multinational.

OPERATIONAL TERMS AND GRAPHICS

friendly fire (JP 1-02) — In casualty reporting, a casualty circumstance applicable to persons killed in action or wounded in action mistakenly or accidentally by friendly forces actively engaged with the enemy, who are directing fire at a hostile force or what is thought to be a hostile force. (See also casualty and fratricide.)

friendly force information requirements (FFIR) — Information the commander and staff need about the forces available for the operation. This includes personnel, maintenance, supply, ammunition, and petroleum, oils, and lubricants (POL) status, and experience and leadership capabilities. (See also battle-field visualization and commander's critical information requirements (CCIR). See FMs 34-1, 71-100, 100-15, and 101-5.

front(JP 1-02, NATO) — **1.** The lateral space occupied by an element measured from the extremity of one flank to the extremity of the other flank. **2.** The direction of the enemy. **3.** The line of contact of two opposing forces. **4.** When a combat situation does not exist or is not assumed, the direction toward which the command is faced. (See also forward edge of the battle area (FEBA) and forward line of own troops (FLOT).) See FMs 1-111, 6-20, 7-7, 7-8, 7-10, 7-20, 7-30, 17-95, 71-100, 71-123, 100-5, and 100-15.

frontage— The width of the front plus that distance beyond the flanks covered by observation and fire by a unit in combat. (See also front.)

frontal attack (JP 1-02, NATO) — **1.** An offensive maneuver in which the main action is directed against the front of the enemy forces. (DOD) **2.** In air intercept, an attack by an interceptor aircraft that terminates with a heading crossing angle greater than 135 degrees. (Army) — Strikes the enemy across a wide front and over the most direct approaches. It is normally used when commanders possess overwhelming combat power and the enemy is at a clear disadvantage. (See also assault and offensive operations.) See FMs 1-111, 7-7, 7-8, 7-10, 7-20, 7-30, 17-95, 71-100, 71-123, 100-5, and 100-15.

full mission capable (FMC) (JP 1-02) — Material condition of an aircraft or training device indicating that it can perform all of its missions. (See also deadline.) See FMs 63-2, 63-2-1, 63-6, 63-20, and 63-21.

full mobilization. See mobilization.

functional component command (JP 1-02) — A command normally, but not necessarily, composed of forces of two or more Military Departments which may be established across the range of military operations to perform particular operational missions that may be of short duration or may extend over a period of time. (See also command relationship.) See FMs 100-5, 100-15, and JP 3-0.

G

GA — the symbol for the nerve agent tabun. See FM 3-9.

gap (JP 1-02, NATO) — An area within a minefield or obstacle belt, free of live mines or obstacles, whose width and direction will allow a friendly force to pass through in tactical formation. (Army) — **1.** Any break or breach in the continuity of tactical dispositions or formations beyond effective small arms coverage. **2.** A portion of a minefield of specified width in which no mines have been laid to enable a friendly force to pass through in tactical formation. **3.** A ravine, mountain pass, or river that presents an obstacle that must be bridged. (See also lane.) See FMs 5-100, 7-7, 7-8, 7-10, 7-20, 7-30, 34-130, 71-100, 71-123, and 90-13-1. **3-28**

GB — the symbol for the nerve agent sarin. See FM 3-9.

GD — the symbol for the nerve agent soman. See FM 3-9.

general support (GS) (JP 1-02, NATO) — That support which is given to the supported force as a whole and not to any particular subdivision thereof. (See also direct support (DS) and general support-reinforcing (GSR).) See FMs 6-20 series and 10-1.

general support artillery (JP 1-02, NATO) — Artillery which executes the fire directed by the commander of the unit to which it organically belongs or is attached. It fires in support of the operation as a whole rather than in support of a specific subordinate unit. (Army) — A tactical artillery mission. (See also direct support artillery, general support-reinforcing (GSR), and reinforcing.) See FM 6-20 series.

general support-reinforcing (GSR) (JP 1-02) — A tactical artillery mission. General support-reinforcing artillery has the mission of supporting the force as a whole and of providing reinforcing fires for another artillery unit. (See also direct support (DS), general support (GS), and reinforcing.) See FM 6-20 series.

general war (JP 1-02) — Armed conflict between major powers in which the total resources of the belligerents are employed, and the national survival of a major belligerent is in jeopardy. (See also conflict, military operations other than war (MOOTW), and stability and support operations (SASO).)

germ— A disease producing microorganism, microbe, or pathogenic bacterium. The term includes bacteria, rickettsiae, viruses, and fungi. (See also decontamination.) See FMs 3-4 and 3-9.

global information environment (GIE) (Army) — Individuals, organizations, and systems, outside the sphere of military or National Command Authorities control, that gather, process, or disseminate information to national and international audiences. See FM 100-6.

global positioning system (GPS) — A satellite-based system used for accurate positioning and navigation. (See also way point.) See FM 21-26.

graphic (JP 1-02, NATO) — Any and all products of the cartographic and photogrammetric art. A graphic may be a map, chart, or mosaic or even a film strip that was produced using cartographic techniques. (Army) — A hand-drawn or computer-generated picture or symbol that represents units, equipment, suspected or templated enemy units and sites, sites or facilities, control measures, and so forth. Term relates to the design, creation, and preparation of two- or three-dimensional visual products. See AR 25-1.

graves registration (Army) — A subprogram of mortuary affairs that provides for search, recovery, initial identification, and temporary burial of deceased personnel in temporary burial sites and provides maintenance and care of burial sites and the handling and disposition of personal effects.

gray lists — Lists that identify and locate those personalities whose inclinations and attitudes toward the political and military objectives of the United States are obscure. Individuals may be listed on grey lists when they are known to possess information or particular skills required by US forces. **D-4**

gray water — Any nontilet water (nonsewage) which is nonpotable because of its having been used in some way (for example, water from sinks, bathtubs, showers, or laundry operation).

grazing fire (JP 1-02, NATO) — Fire approximately parallel to the ground where the center of the cone of fire does not rise above 1 meter from the ground. (See also direct fire, final protective line (FPL), and dead space.) See FMs 7-7, 7-8, and 7-10.

OPERATIONAL TERMS AND GRAPHICS

Greenwich Mean Time (GMT) (ZULU) — Mean solar time measured at the prime meridian which runs through Greenwich, England. It is used as the basis for calculating time throughout most of the world. (See also Universal Time and ZULU time.) See FM 101-5.

grey propaganda (JP 1-02) — Propaganda that does not specifically identify any source.

grid azimuth — An angle of direction referenced to grid north. It differs from true azimuth by the amount of the grid convergence. (See also azimuth.) See FM 21-26.

grid convergence (JP 1-02) — The horizontal angle at a place between true north and grid north. It is proportional to the longitude difference between the place and the central meridian. (See also grid azimuth and magnetic azimuth.) See FM 21-26.

grid coordinates (JP 1-02, NATO) — Coordinates of a grid coordinate system to which numbers and letters are assigned for use in designating a point on a gridded map, photograph, or chart. (Army) — The easting and northing values (of a grid) that designate the location of a point in respect to the grid. Coordinates usually are expressed to the nearest 100, 10, or 1 meter, with the easting and northing values combined into a single expression. Examples: NK 329378 (nearest 100 meters); NK 32943785 (nearest 10 meters); or NK 3294837853 (nearest 1 meter). See FM 21-26.

grid north (JP 1-02, NATO) — The northerly or zero direction indicated by the grid datum of directional reference. See FM 21-26.

ground combat element (GCE) (JP 1-02) — The Marine air-ground task force (MAGTF) element that is task-organized to conduct ground operations. The GCE is constructed around an infantry unit and varies in size from a reinforced infantry battalion to one or more reinforced Marine division(s). The GCE also includes appropriate combat support and combat service support units. Normally, there is only one GCE in a MAGTF.

ground tactical plan (Army) — An airborne or air assault operational plan covering the conduct of operations in the objective area. (See also echelonment, landing plan, and marshalling plan.) See FMs 7-7, 7-10, 7-20, 7-30, 90-4, 90-26, 71-100-2, and 71-100-3.

ground zero (GZ) (JP 1-02, NATO) — The point on the surface of the Earth at, or vertically below or above, the center of a planned or actual nuclear detonation. (See also desired ground zero (DGZ).) See FMs 3-3-1, 100-30, JPs 3-12.2, and 3-12.3. **3-34**

group (JP 1-02) — **1.** A flexible administrative and tactical unit composed of either two or more battalions or two or more squadrons. The term also applies to combat support and combat service support units. **2.** A number of ships and/or aircraft, normally a subdivision of a force, assigned for a specific purpose.

group of targets (JP 1-02, NATO) — Two or more targets on which fire is desired simultaneously. A group of targets is designated by a letter/number combination or a nickname. (See also fire plan.) See FM 6-20 series. **3-23**

g-series nerve agents — A series of fluorine- or cyanide-containing organophosphate nerve agents (organophosphate derivatives of phosphoric acid). In their unmodified state they are colorless, volatile liquids. (See also GA, GB, and GD.) See FM 3-9.

guard (JP 1-02, NATO) — A security element whose primary task is to protect the main force by fighting to gain time, while also observing and reporting information. (Army) — A form of security operation

whose primary task is to protect the main force by fighting to gain time while also observing and reporting information, and to prevent enemy ground observation of and direct fire against the main body by reconnoitering, attacking, defending, and delaying. A guard force normally operates within the range of the main body's indirect fire weapons. (See also cover, flank guard, screen, and security operations.) See FMs 7-30, 17-95, 71-100, 71-123, 100-5, and 100-15. **C-11**

guerrilla warfare (JP 1-02, NATO) — Military and paramilitary operations conducted in enemy-held or hostile territory by irregular, predominantly indigenous forces. (See also unconventional warfare (UW).) See FMs 90-8, 100-12, and 100-20.

gun-target line (JP 1-02, NATO) — An imaginary straight line from the gun(s) to the target. (See also observer-target line.) See FMs 6-series and 7-90.

H

H — The symbol for LeVinson mustard, a blister agent. See FM 3-9.

habitual association — The close and continuous relationship established between support elements and the combat units they support or between combat units that frequently are cross-attached to ensure a mutual understanding of operating procedures and techniques and to increase overall responsiveness.

handover line (JP 1-02, NATO) — A control feature, preferably following easily defined terrain features, at which responsibility for the conduct of combat operations is passed from one force to another. (Army) — **1.** The handover line applies to other functions besides combat, such as intelligence, electronic warfare, and information warfare. **2.** The action is complete when the receiving commander acknowledges assumption of control authority. (See also phase line (PL).) See FMs 1-111, 7-10, 7-20, 7-30, 17-95, 71-100, 71-123, 100-5, and 100-15.

hang fire (JP 1-02, NATO) — An undesired delay in the functioning of a firing system. (Army) — An undesired delay in the functioning of the primer or initiator part of a round of ammunition. See FMs 6-20 series, 7-91, 17-12, and 23-1.

harassing fire (JP 1-02, NATO) — Fire designed to disturb the rest of the enemy troops, to curtail movement, and, by threat of losses, to lower morale. (See also fire and fire support.) See FM 6-20 series.

hasty attack (JP 1-02, NATO) — In land operations, an attack in which preparation time is traded for speed in order to exploit an opportunity. (Army) — Result of a meeting engagement—launched with the forces at hand and with minimum preparation to destroy the enemy before he is able to concentrate or establish a defense. (See also assault, attack, deliberate attack, and movement to contact.) See FMs 1-111, 1-112, 1-116, 7-7, 7-8, 7-10, 7-20, 7-30, 17-95, 71-100, 71-123, 100-5, and 100-15.

hasty crossing (JP 1-02, NATO) — The crossing of an inland water obstacle using the crossing means at hand or those readily available, and made without pausing for elaborate preparations. (See also bridgehead and deliberate crossing.) See FMs 7-7, 7-20, 7-30, 17-95, 71-100, 71-123, 90-13, 100-5, and 100-15.

hasty defense (JP 1-02, NATO) — A defense normally organized while in contact with the enemy or when contact is imminent and time available for the organization is limited. It is characterized by improvement of the natural defensive strength of the terrain by utilization of foxholes, emplacements, and obstacles. (See also defend, deliberate defense, emplacement, and obstacle.) See FMs 7-7, 7-8, 7-10, 7-20, 7-30, 17-15, 17-95, 71-100, 71-123, 100-5, and 100-15.

OPERATIONAL TERMS AND GRAPHICS

hasty smoke — Smoke operations characterized by minimal planning and short duration to immediately counter enemy action. See FM 3-100.

hazard — Any real or potential condition that can cause injury, illness, or death of personnel, or damage to or loss of equipment or property.

hazardous material — Any substance which has a human health hazard associated with it. Special storage, use, handling, and shipment safety procedures and protocols must be followed to help protect against accidental human exposure. Hazardous materials are specifically identified under federal law.

hazardous substances — Materials specifically listed under federal regulations for which the spilling of certain quantities requires immediate reporting to federal agencies.

hazardous waste — A solid waste which is either listed as such in federal law or exhibits any of the four hazardous characteristics—ignitability, corrosivity, reactivity, or toxicity.

hazardous waste accumulation site — A specially designated site for the temporary collection of hazardous wastes where no container may remain on site for more than 90 days. The site, and containers within it, must be properly marked and certain safety and management procedures apply. There is no limitation on the quantity of wastes which may be kept on site.

haze (smoke) — A light concentration of smoke placed over friendly areas to restrict accurate enemy observation and fire. A smoke haze is not dense enough to disrupt friendly operations. See FM 3-50.

HD — The symbol for distilled Levinstein mustard, a blister agent. See FM 3-9.

heavy drop (HD) (JP 1-02) — A system of delivery of heavy supplies and equipment by parachute. See FM 10-1.

height of burst (HOB) (JP 1-02, NATO) — The vertical distance from the Earth's surface or target to the point of burst. (See also desired ground zero (DGZ) and ground zero (GZ).) See FM 100-30.

herbicide(JP 1-02) — A chemical compound that will kill or damage plants. (Army) — The term includes defoliants, desiccants, plant-growth regulators, and soil sterilants. See FMs 3-9 and 3-100.

herringbone — An arrangement of vehicles at left and right angles to the line of march used to establish security during an unscheduled halt. See FMs 7-7, 17-15, and 55-2.

H-hour (JP 1-02) — The specific hour on D-day at which a particular operation commences. (Army) — It may be the commencement of hostilities; the hour at which an operation plan is executed or is to be executed (as distinguished from the hour the order is issued); or the hour that the operation phase is implemented. The highest command or headquarters coordinating planning specifies the exact meaning of H-hour within the above definition. When several operations or phases of an operation are being conducted in the same area on D-day and confusion may arise over the use of the same hour designation, the letters F, L, S, W, and Y may be used. When this is done, the letters used and their meaning must be stated in the plan or order. Reference to hours preceding or following H-hour will be referred to by using a plus or minus sign and an Arabic numeral following the letter H. For example: H-3 is 3 hours prior to H-hour; H+7 is 7 hours after H-hour. If a time element other than hours is expressed, it must be spelled out (such as H+30 minutes). (See also D-day.)

hide — The positioning of a vehicle, individual, or unit so that no part is exposed to observation or direct fire. (See also concealment, cover, defilade, hull down, and turret down.) See FMs 7-7, 17-12, 17-15, and 23-1.

high angle fire (JP 1-02, NATO) — Fire delivered at angles of elevation greater than the elevation that corresponds to the maximum range of the gun and ammunition concerned; fire, the range of which decreases as the angle of elevation is increased. (Army) — Fire delivered to clear an obstacle (such as a hill) that low-angle fire cannot, or fire delivered to attack targets on the reverse side of an obstacle (such as a hill) that cannot be attacked with low-angle or direct fire. See FMs 6-series and 7-90.

high-density airspace control zone (HIDACZ) (JP 1-02) — Airspace designated in an airspace control plan or airspace control order, in which there is a concentrated employment of numerous and varied weapons and airspace users. A high-density airspace control zone has defined dimensions, which usually coincide with geographical features or navigational aids. Access to a high-density airspace control zone is normally controlled by the maneuver commander. The maneuver commander can also direct a more restrictive weapons status within the high-density airspace control zone. (See also airspace coordination area (ACA) and restricted operating zone (ROZ).) See FMs 1-111 and 100-103. **3-6**

high-payoff target (HPT) — A target whose loss to the threat will contribute to the success of the friendly course of action. See FMs 6-20 series and 34-130.

high-value target (HVT) — Assets that the threat commander requires for the successful completion of a specific course of action. See FMs 6-20 series and 34-130.

highway regulation — Planning, routing, scheduling, and deconflicting the use of main supply routes and other routes to provide order, prevent congestion, enforce priorities, and facilitate movement control. (See also main supply route (MSR) and alternate supply route (ASR).) See FMs 19-1 and 55-2.

HL — The symbol for a blister agent consisting of mustard-lewisite mixture. See FM 3-9.

HN — The symbol for nitrogen mustard, a blister agent. See FM 3-9.

hold (JP 1-02, NATO) — **1.** A cargo stowage compartment aboard ship. **2.** To maintain or retain possession of by force, as a position or an area. **3.** In an attack, to exert sufficient pressure to prevent movement or redistribution of enemy forces. **4.** As applied to air traffic, to keep an aircraft within a specified space or location which is identified by visual or other means in accordance with air traffic control instructions. (See also block, fix, and retain.) See FMs 7-7, 7-8, 7-10, 7-20, 7-30, 17-15, 17-95, 71-100, 71-123, 100-5, and 100-15.

hold fire (JP 1-02, NATO) — In air defense, an emergency order to stop firing. Missiles already in flight must be prevented from intercepting, if technically possible. See FM 44-100.

holding area (Army) — **1.** A site located between assembly areas or forward arming and refueling points and battle positions (BPs) that may be occupied for short periods of time by attack helicopters while coordination is being made for movement into BPs. It should provide good cover and concealment and an area for the aircraft to hover or land. See FMs 1-111, 1-112, and 1-116. **2.** Nearest covered and concealed position to the pickup zone or river crossing site where troops are held until time for them to move forward. See FMs 7-8, 7-10, 7-20, 7-30, 71-100-2, 71-100-3, and 90-13. **3.** Waiting area that forces use during traffic interruptions or deployment from an aerial or seaport of embarkation. See FMs 19-1 and 55-2.

OPERATIONAL TERMS AND GRAPHICS

holding line (Army) — In retrograde river crossing operations, the outer limit of the area established between the enemy and the water obstacle to preclude direct and observed indirect fires into crossing areas. (See also bridgehead line.) See FMs 7-30, 71-100, 71-123, 90-13, and 100-15. **3-20**

hospital (JP 1-02) — A medical treatment facility capable of providing inpatient care. It is appropriately staffed and equipped to provide diagnostic and therapeutic services, as well as the necessary supporting services required to perform its assigned mission and functions. A hospital may, in addition, discharge the functions of a clinic. **4-26** **D-9**

hostage (JP 1-02) — A person held as a pledge that certain terms or agreements will be kept. (The taking of hostages is forbidden under the Geneva Conventions, 1949.) See FM 100-20.

host country (JP 1-02) — A nation in which representatives or organizations of another state are present because of government invitation and/or international agreement. (See also civil military operations (CMO) and host nation). See FMs 100-5 and 100-20.

hostile (JP 1-02) — A contact positively identified as enemy. (Army) — An individual, a group of individuals, or a nation which is antagonistic or opposes policies and actions of the United States and its allies. The actions of a hostile can be political, diplomatic, or at any level of war. See FM 100-20.

hostile acts (JP 1-02) — Basic rules established by higher authority for defining and recognizing hostile acts by aircraft, submarines, surface units, and ground forces that will be promulgated by the commanders of unified or specified commands, and by other appropriate commanders when so authorized.

hostile casualty (JP 1-02) — A person who is the victim of a terrorist activity or who becomes a casualty "in action." "In action" characterizes the casualty as having been the direct result of hostile action, sustained in combat or relating thereto, or sustained going to or returning from a combat mission provided that the occurrence was directly related to hostile action. Included are persons killed or wounded mistakenly or accidentally by friendly fire directed at a hostile force or what is thought to be a hostile force. However, not to be considered as sustained in action and not to be interpreted as hostile casualties are injuries or death due to the elements, self-inflicted wounds, combat fatigue, and except in unusual cases, wounds or death inflicted by a friendly force while the individual is in an absent-without-leave, deserter, or dropped-from-rolls status or is voluntarily absent from a place of duty. (See also casualty and nonhostile casualty.)

hostile criteria — Description of conditions under which an aircraft or a vehicle may be identified as hostile for engagement purposes. (See also hostile acts and rules of engagement (ROE).)

hostile environment — *See* operational environment.

host nation — A nation which receives the forces and/or supplies of allied or coalition nations and/or NATO organizations to be located on, to operate in, or to transit through its territory. (See also civil military operations (CMO) and host country.) See FMs 100-5 and 100-20.

host-nation support (JP 1-02) — Civil and/or military assistance rendered by a nation to foreign forces within its territory during peacetime, crises or emergencies, or war based on agreements mutually concluded between nations. (See also civil military operations (CMO).) See FMs 100-5, 100-10, and 100-20.

H-series agents — A series of persistent blister agents that include distilled mustard (HD), and the nitrogen mustards. See FM 3-9.

HT — The symbol for a mustard-T mixture, a blister agent. See FM 3-9.

hull down — The positioning of an armored vehicle so that the muzzle of the gun or launcher is the lowest part of the vehicle exposed to the front. Hull-down positions afford maximum protection for vehicles that are engaging targets with direct fire. (See also hide and turret down.) See FMs 7-7, 17-12, 17-15, and 23-1.

human intelligence (HUMINT) (JP 1-02, NATO) — A category of intelligence derived from information collected and provided by human sources. See FMs 34-2 and 34-3.

humanitarian assistance (HA) (JP 1-02) — Programs conducted to relieve or reduce the results of natural or man-made disasters or other endemic conditions such as human pain, disease, hunger, or privation that might present a serious threat to life or that can result in great damage to or loss of property. Humanitarian assistance provided by US forces is limited in scope and duration. The assistance provided is designed to supplement or complement the efforts of the host nation civil authorities or agencies that may have the primary responsibility for providing humanitarian assistance. See FMs 8-42 and 100-20.

humanitarian assistance coordination center (HACC) — Normally a subordinate element of the civil military operations center that deals directly with those agencies and organizations involved in humanitarian assistance efforts. In certain situations, particularly when participation for a specific operation by US armed forces is not extensive, a HACC can be formed as a separate, stand-alone organization. See FM 100-20.

humanitarian and civic assistance (HCA) (JP 1-02) — Assistance to the local populace provided by predominantly US forces in conjunction with military operations and exercises. This assistance is specifically authorized by Title 10, United States Code, section 401, and funded under separate authorities. Assistance provided under these provisions is limited to (1) medical, dental, and veterinary care provided in rural areas of a country; (2) construction of rudimentary surface transportation systems; (3) well drilling and construction of basic sanitation facilities; and (4) rudimentary construction and repair of public facilities. Assistance must fulfill unit training requirements that incidentally create humanitarian benefit to the local populace. (See also humanitarian assistance (HA).) See FMs 8-42 and 100-20.

hybrid collective protection — A combination of overpressure and ventilated face-piece systems. See FM 3-4.

hydrolysis — Interaction of a chemical agent with water to yield a less toxic product or products. See FM 3-9.

I

identification, friend or foe (IFF) (JP 1-02, NATO) — A system using electromagnetic transmissions to which equipment carried by friendly forces automatically responds, for example, by emitting pulses, thereby distinguishing themselves from enemy forces. (Army) — A device which emits a signal positively identifying it as a friendly. (See also air defense.) See FMs 1-111, 44-100, and 100-103.

identification, friend or foe (IFF) on/off line (Army) — A theater-directed phase line where aircraft involved in deep operations forward of the fire support coordination line turn off the aircraft IFF transponder *en route* to the target and turn on the transponder after completing the mission. (See also identification, friend or foe (IFF), and phase line (PL).) See FM 100-103.

OPERATIONAL TERMS AND GRAPHICS

imagery intelligence (IMINT) (JP 1-02) — Intelligence derived from the exploitation of collection by visual photography, infrared sensors, lasers, electro-optics, and radar sensors, such as synthetic aperture radar wherein images of objects are reproduced optically or electronically on film, electronic display devices, or other media. (See also intelligence.) See FMs 34-1, 34-3, and 34-10.

imitative electromagnetic deception (IED) (JP 1-02) — The introduction of electromagnetic energy into enemy systems that imitates enemy emissions. (Army) — Imitating enemy electromagnetic radiation (predominately communications) after intruding his electromagnetic channels to deceive him or to disrupt his operations. (See also command and control warfare (C²W), deception, electronic warfare (EW), manipulative electromagnetic deception, and simulative electromagnetic deception.) See FMs 34-1, 34-10, 34-40, 90-2, and 100-6.

immediate air support (JP 1-02, NATO) — Air support to meet specific requests which arise during the course of a battle and which by their nature cannot be planned in advance. (See also air support.) See FM 6-series.

immediate decontamination (JP 1-02, NATO) — Decontamination carried out by individuals upon becoming contaminated, to save life and minimize casualties. This may include decontamination of some personal clothing and/or equipment. (See also decontamination.) See FM 3-5.

immediate mission request (JP 1-02) — A request for an air strike on a target which by its nature could not be identified sufficiently in advance to permit detailed mission coordination and planning. (NATO: a request for immediate air support.)

immediate permanent ineffectiveness, 8,000 cGy — The physiological response to radiation at levels of 3,000 cGy for physically demanding tasks or 3,800 cGy for physically undemanding tasks. Personnel become ineffective within three minutes of exposure and remain ineffective until death. Death occurs within one day. See FM 3-3-1.

immediate transient ineffectiveness (nuclear) — The physiological response to radiation at levels of 2,000 cGy for physically demanding tasks or 2,800 cGy for physically undemanding tasks. Personnel irradiated by a nuclear explosion or accident become ineffective for any task within 3 minutes of exposure and remain so for approximately 7 minutes, independent of the physical demands of the task. Personnel recover to greater than 75 percent of their pre-exposure performance levels at around 10 minutes postexposure and remain so for around 30 minutes. At around 40 minutes postexposure, personnel become performance-degraded and remain so for around five hours for undemanding tasks (two hours for demanding tasks), at which time it is expected that radiation sickness symptoms will be present in sufficient severity to render the personnel ineffective. The personnel will remain ineffective until death occurs in five to six days. See FM 3-3-1 and JPs 3-12.2 and 3-12.3.

implementation force (IFOR) — A task-organized military command which is to execute and enforce an international treaty or agreement. This command performs the missions and tasks as defined in the treaty or agreement. The missions and tasks may include peace operations, nation building, peace enforcement, and humanitarian assistance. (See also peace operations and stability and support operations (SASO).) See FM 100-23.

incapacitating agent (JP 1-02) — An agent that produces temporary physiological or mental effects, or both, that will render individuals incapable of concerted effort in the performance of their assigned duties. See FM 3-9 and FM 3-100.

incendiary— A compound that generates sufficient heat to cause the target to catch fire or causes melting or burning of equipment. See FM 3-9.

in-depth defense — A choice of defensive maneuver that forces the enemy to attack through a series of mutually supporting friendly positions, causing the enemy's mass to be expended and his supporting forces to be unable to focus. This choice of maneuver reduces the risk of an enemy penetration and allows the enemy to gain terrain to wear him down and overextend his ability to sustain his attack. In-depth defense usually culminates in a friendly counterattack to complete the destruction of the enemy and regain lost terrain. (See also choices of maneuver and defensive operations.)

indirect approach (Army) — To attack an enemy at his weakness to cause his strength to be ineffective, ultimately resulting in his defeat.

indirect fire (JP 1-02) — Fire delivered on a target that is not itself used as a point of aim for the weapons or the director. (Army) — Fire delivered on a target characterized by a relatively high trajectory and where the weapon operator normally does not have visual contact with the target. (See also direct laying.) See FMs 6-20 series and 7-90.

indirect illumination (JP 1-02, NATO) — Battlefield illumination provided by employing searchlight or pyrotechnic illuminants using diffusion or reflection. **a. Illumination by diffusion:** Illumination of an area beneath and to the flanks of a slightly elevated searchlight or of pyrotechnic illuminants, by the light scattered from atmospheric particles. **b. Illumination by reflection:** Illumination of an area by reflecting light from low cloud. Either or both of these effects are present when a searchlight is used in defilade or with its beam spread to maximum width.

individual protection — **1.** Actions taken by individual soldiers to survive and continue the mission under nuclear, biological, chemical (NBC) conditions. See FM 3-100 **2.** Actions taken by individual soldiers to protect themselves from the effects of direct and indirect fire. See FMs 5-103, 7-7, and 7-8.

induced radiation (JP 1-02, NATO) — Radiation produced as a result of exposure to radioactive materials, particularly the capture of neutrons. See FM 3-3-1.

in extremis (JP 1-02) — A situation of such exceptional urgency that immediate action must be taken to minimize imminent loss of life or catastrophic degradation of the political or military situation. See FM 100-20.

infiltration (JP 1-02) — **1.** The movement through or into an area or territory occupied by either friendly or enemy troops or organizations. The movement is made, either by small groups or by individuals, at extended or irregular intervals. When used in connection with the enemy, it infers that contact is avoided. **2.** In intelligence usage, placing an agent or other person in a target area in hostile territory. Usually involves crossing a frontier or other guarded line. Methods of infiltration are: black (clandestine); grey (through legal crossing point but under false documentation); white (legal). (Army) — **1.** A choice of maneuver that entails movement through or into an area occupied by an enemy or a friendly force by small groups or individuals at extended or irregular intervals in which contact with the enemy is avoided. **2.** When used in conjunction with a tactical vehicular march, vehicles are dispatched individually or in small groups at irregular intervals to reduce density and prevent undue massing of vehicles. (See also choices of maneuver and exfiltration.) See FMs 7-7, 7-8, 7-10, 7-20, 7-30, 17-95, 31-20, 34-1, 71-100, 71-123, 100-5, and 100-15. **3-16**

inflight report (JP 1-02) — The transmission from the airborne system of information obtained both at the target and *en route*.

informant (JP 1-02) — **1.** A person who, wittingly or unwittingly, provides information to an agent, a clandestine service, or the police. **2.** In reporting, a person who has provided specific information and

OPERATIONAL TERMS AND GRAPHICS

is cited as a source. (See also human intelligence (HUMINT), military operations other than war (MOOTW), and support and stability operations (SASO).) See FMs 34-1 and 100-20.

information (JP 1-02, NATO) — **1.** Facts, data, or instructions in any medium or form. (DOD) **2.** The meaning that a human assigns to data by means of the known conventions used in their representation. See FMs 34-1 and 100-6.

information dominance (Army) — The degree of information superiority that allows the possessor to use information systems and capabilities to achieve an operational advantage in a conflict or to control the situation in stability and support operations, while denying those capabilities to the adversary. See FM 100-6.

information operations (IO) — Continuous military operations within the military information environment that enable, enhance, and protect the friendly force's ability to collect, process, and act on information to achieve an advantage across the full range of military operations. Information operations include interacting with the global information environment and exploiting or denying an adversary's information and decision capabilities. See FM 100-6.

information requirements (IR) (JP 1-02, NATO) — Those items of information regarding the enemy and his environment which need to be collected and processed in order to meet the intelligence requirements of a commander. (See also commander's critical information requirements (CCIR) and priority intelligence requirements (PIR).) See FMs 34-1, 34-10, 34-130, and 101-5.

information systems (Army) — The entire infrastructure, organization, personnel, and components that collect, process, store, transmit, display, disseminate, and act on information. See FM 100-6.

information systems security (ISS) — The protection of information systems against unauthorized access to or modification of information, whether in storage, processing, or transit, and against denial of service to authorized users or the providing of access to unauthorized users, including those measures necessary to detect, document, and counter such threats. See FM 100-6.

information warfare (IW) (Army) — Actions taken to achieve information superiority by affecting a hostile's information, information-based processes, and information systems, while defending one's own information, information-based processes, and information systems. See FM 100-6.

infosphere (Army) — The rapidly growing global network of military and commercial command, control, communications, and computer systems and networks linking information databases and fusion centers that are accessible to the warrior anywhere, anytime, and during the performance of any mission. The infosphere provides the worldwide automated information exchange backbone that provides support to forces and provides seamless operations from anywhere to anywhere. The network of databases and fusion centers is secure, and its complexity is transparent to the warrior user. This emerging capability is highly flexible and can support the adaptive command and control infrastructures of the twenty-first century. See FM 100-6.

infrastructure (JP 1-02, NATO) — A term generally applicable to all fixed and permanent installations, fabrications, or facilities for the support and control of military forces. (Army) — **1.** The basic, underlying framework or features of a thing. **2.** In economics, basic resources, communications, industries, and so forth, upon which others depend. **3.** In insurgency, the organization (usually hidden) of insurgent leadership. See FMs 100-5 and 100-20.

initial nuclear effects — Effects that occur within the first minute and includes initial nuclear radiation, blast, thermal, and electromagnetic pulse. See FMs 3-3-1, 100-30, JPs 3-12.2, and 3-12.3.

initial point (IP) (JP 1-02) — **1.** The first point at which a moving target is located on a plotting board. **2.** A well-defined point, easily distinguishable visually and/or electronically, used as a starting point for the bomb run to the target. See FM 6-20 series. **3.** Airborne—a point close to the landing area where serials (troop carrier air formations) make final alterations in course to pass over individual drop or landing zones. See FMs 7-7, 7-10, 7-20, 7-30, 71-100-2, and 90-26. **4.** Helicopter—an air control point in the vicinity of the landing zone from which individual flights of helicopters are directed to their prescribed landing sites. **5.** Any designated place at which a column or element thereof is formed by the successive arrival of its various subdivisions, and comes under the control of the commander ordering the move. See FMs 1-111 and 100-103.

initial response force (JP 1-02) — The first unit, usually military police, on the scene of a terrorist incident. (See also antiterrorism (AT).) See FM 19-1.

initiative (Army) — The ability to set or change the terms of battle; implies an offensive spirit.

injury(JP 1-02) — A term comprising such conditions as fractures, wounds, sprains, strains, dislocations, concussions, and compressions. In addition, it includes conditions resulting from extremes of temperature or prolonged exposure. Acute poisonings, except those due to contaminated food, resulting from exposure to a toxic or poisonous substance are also classed as injuries.

insertion(Army) — **1.** Placement of troops and equipment into an operational area in air assault operations. **2.** The placement of observation posts, patrols, or raiding parties either by helicopter or parachute. (See also air assault.) See FMs 1-111, 71-100-3, and 90-4.

in-stride breach — A type of breaching used by maneuver units to quickly overcome unexpected or lightly defended tactical obstacles. Maneuver battalions and companies are task-organized with the assets necessary to conduct independent breaching operations. These include mine rollers, mine plows, engineers, priority of artillery, mortars, close air support, air defense, smoke targets, and smoke generators. (See also breach and deliberate breach.) See FM 90-13-1.

insurgency (JP 1-02, NATO) — An organized movement aimed at the overthrow of a constituted government through the use of subversion and armed conflict. (See also counterinsurgency.) See FMs 90-8 and 100-20.

integrated combat airspace command and control (ICAC²) — A system capable of linking and coordinating the airspace use and restrictions of all Services and a host nation, which may include aircraft, air defense, rocket artillery, unmanned aerial vehicles, and other high trajectory weapon systems, in order to maximize the accommodation of mission requirements. (See also Army airspace command and control (A²C²).) See FM 100-103-1.

integrated warfare (JP 1-02) — The conduct of military operations in any combat environment wherein opposing forces employ nonconventional weapons in combination with conventional weapons. See FM 3-100.

intelligence (JP 1-02) — **1.** The product resulting from the collection, processing, integration, analysis, evaluation, and interpretation of available information concerning foreign countries or areas. **2.** Information and knowledge about an adversary obtained through observation, investigation,

OPERATIONAL TERMS AND GRAPHICS

analysis, or understanding. (See also combat intelligence and imagery intelligence (IMINT).) See Fms 34-1, 34-10, and 34-40.

intelligence collection plan (JP 1-02) — A plan for gathering information from all available sources to meet an intelligence requirement. Specifically, a logical plan for transforming the essential elements of information into orders or requests to sources within a required time limit. (See also commander's critical information requirements (CCIR), intelligence cycle, and reconnaissance and surveillance plan.) See FMs 34-1, 34-10, 34-10-2, 34-130, and 101-5.

intelligence cycle (JP 1-02) — The steps by which information is converted into intelligence and made available to users. There are five steps in the cycle: **a. planning and direction** — Determination of intelligence requirements, preparation of a collection plan, issuance of orders and requests to information collection agencies, and a continuous check on the productivity of collection agencies. **b. collection** — Acquisition of information and the provision of this information to processing and/or production elements. **c. processing** — Conversion of collected information into a form suitable to the production of intelligence. **d. production** — Conversion of information into intelligence through the integration, analysis, evaluation, and interpretation of all source data and the preparation of intelligence products in support of known or anticipated user requirements. **e. dissemination** — Conveyance of intelligence to users in a suitable form. (See also intelligence and intelligence collection plan.) See FM 34-1.

intelligence preparation of the battlefield (IPB) — A systematic approach to analyzing the enemy, weather, and terrain in a specific geographic area. It integrates enemy doctrine with the weather and terrain as they relate to the mission and the specific battlefield environment. This is done to determine and evaluate enemy capabilities, vulnerabilities, and probable courses of action. See FMs 34-130 and 101-5.

intelligence preparation of the battlespace (JP 1-02) — An analytical methodology employed to reduce uncertainties concerning the enemy, environment, and terrain for all types of operations. Intelligence preparation of the battlespace builds an extensive data base for each potential area in which a unit may be required to operate. The data base is then analyzed in detail to determine the impact of the enemy, environment, and terrain on operations and presents it in graphic form. Intelligence preparation of the battlespace is a continuing process.

intelligence synchronization matrix — A graphic representation that ties the collection plan to an operation and the commander's intelligence needs.

interagency — Activities or operations conducted by or through coordination with two or more agencies or an agency and one or more services of the same nation.

interagency operations — Any action which combines the human and material resources of two or more independent organizations, be they governmental, international, or private, in prosecution of a common objective. See FM 100-5.

interdict — Using fire support or maneuver forces; **1.** To seal off an area by any means; to deny use of a route or approach. **2.** A tactical task which is oriented on the enemy to prevent, hinder, or delay the use of an area or route by enemy forces. See FMs 1-111, 1-112, 7-30, 17-95, 71-100, 71-123, and 100-15.

C-9

interdiction (JP 1-02) — An action to divert, disrupt, delay, or destroy the enemy's surface military potential before it can be used effectively against friendly forces. See FMs 1-111, 1-112, 7-30, 17-95, 71-100, 71-123, and 100-15.

interdiction fire (NATO) — Fire placed on an area or point to prevent the enemy from using the area or point. (See also interdict and interdiction.) See FMs 6-series and 7-90.

intermediate staging base (ISB) — A logistics base established to provide support to deploying units *en route* to an operation; area established to ensure continuity of support. The use of an ISB allows supported tactical and operational commanders time to gather additional intelligence on the area of operations and finalize plans following briefings and rehearsals, and provides time during which units may redistribute and finalize their accompanying loads. See FM 100-15.

internal defense and development (IDAD) (JP 1-02) — The full range of measures taken by a nation to promote its growth and to protect itself from subversion, lawlessness, and insurgency. It focuses on building viable institutions (political, economic, social, and military) that respond to the needs of society. (See also foreign internal defense (FID).) See FMs 100-20 and 100-25.

internal security (JP 1-02) — The state of law and order prevailing within a nation. (See also internal defense and development (IDAD) and foreign internal defense (FID).) See FMs 100-20 and 100-25.

interned (JP 1-02) — A casualty definitely known to have been taken into custody of a nonbelligerent foreign power as the result of and for reasons arising out of any armed conflict in which the Armed Forces of the United States are engaged. (Army) — **1.** Battle casualties taken into custody by a nonbelligerent foreign power as a result of any armed conflict. **2.** Anyone taken and kept as a prisoner of war.

interoperability (JP 1-02, NATO) — **1.** The ability of systems, units, or forces to provide services to and accept services from other systems, units, or forces and to use the services so exchanged to enable them to operate effectively together. (DOD) **2.** The condition achieved among communications-electronics systems or items of communications-electronics equipment when information or services can be exchanged directly and satisfactorily between them and/or their users. The degree of interoperability should be defined when referring to specific cases. See FMs 100-5 and 100-6.

intervisibility (IV) — The condition of being able to see one point from another. This condition may be altered or interrupted by weather, smoke, terrain masking, dust, or debris. (See also concealment and cover.) See FM 34-130.

intervisibility line — A ridge or horizon beyond which equipment or personnel can be hidden from observation. (See FM 34-130.)

in-transit visibility (Army) — The capability to identify the location of resources at any moment in the distribution pipeline. See FMs 10-1 and 55-2.

intrusion (JP 1-02) — The intentional insertion of electromagnetic energy into transmission paths in any manner, with the objective of deceiving operators or of causing confusion. (See also electronic warfare (EW); jamming; and meaconing, intrusion, jamming, and interference (MIJI) report.) See FMs 34-1, 34-40, and 100-6.

inversion — An increase of air temperature with increase in altitude (the ground being colder than the surrounding air). When an inversion exists, there are no convection currents and wind speeds are below 5 knots. The atmosphere is stable and normally is considered the most favorable state for ground release of chemical agents. (See also haze, lapse, and neutral.) See FM 3-6.

OPERATIONAL TERMS AND GRAPHICS

irregular forces (JP 1-02) — Armed individuals or groups who are not members of the regular armed forces, police, or other internal security forces. See FMs 100-20 and 100-25.

irregular outer edge (JP 1-02, NATO) — In land mine warfare, short mine rows or strips laid in an irregular manner in front of a minefield facing the enemy to deceive the enemy as to the type or extent of the minefield. Generally, the irregular outer edge will only be used in minefields with buried mines.

isolate— A tactical task given to a unit to seal off (both physically and psychologically) an enemy from his sources of support, to deny an enemy freedom of movement, and prevent an enemy unit from having contact with other enemy forces. An enemy must not be allowed sanctuary within his present position. (See also encirclement.) See FMs 7-7, 7-8, 17-95, and 71-123. **C-10**

J

jamming — The deliberate radiation, reradiation, or reflection of electromagnetic energy to prevent or degrade the receipt of information by a receiver. It includes communications and noncommunications jamming. (See also barrage jamming, command and control warfare (C²W), electromagnetic interference (EMI), electronic attack (EA), electronic warfare (EW), imitative electronic deception (IED), intrusion, and meaconing.) See FMs 34-1, 34-40, and 100-6.

joint air attack team (JAAT) (Army) — A combination of US Army attack and scout aircraft and fixed-wing close air support (CAS) aircraft operating together to locate and attack high-priority lucrative targets such as tanks and other targets of opportunity. JAAT normally operates in a coordinated effort with fire support, air defense artillery, and ground maneuver forces against enemy armored formations, command vehicles, and enemy air defense weapon systems. See FMs 1-112 and 6-20 series.

joint civil affairs task force (JCATF) (Army) — A joint task force composed of civil affairs units from more than one service, formed to carry out a specific civil affairs operation or prosecute civil affairs in support of a theater campaign or other operations. The JCATF may have conventional noncivil affairs units assigned or attached to support the conduct of specific missions.

joint force (JP 1-02) — A general term applied to a force composed of significant elements, assigned or attached, of two or more Military Departments, operating under a single joint force commander. See FMs 100-5, 100-15, 100-20, and JP 0-2.

joint force air component commander (JFACC) (JP 1-02) — The joint force air component commander derives authority from the joint force commander who has the authority to exercise operational control, assign missions, direct coordination among subordinate commanders, redirect and organize forces to ensure unity of effort in the accomplishment of the overall mission. The joint force commander will normally designate a joint force air component commander. The joint force air component commander's responsibilities will be assigned by the joint force commander (normally these would include, but not be limited to, planning, coordination, allocation, and tasking based on the joint force commander's apportionment decision). Using the joint force commander's guidance and authority, and in coordination with other Service component commanders and other assigned or supporting commanders, the joint force air component commander will recommend to the joint force commander apportionment of air sorties to various missions or geographic areas. (See also joint force commander (JFC).) See FMs 71-100 and 100-15.

joint force commander (JFC) (JP 1-02) — A general term applied to a combatant commander, subunified commander, or joint task force commander authorized to exercise combatant command (command authority) or operational control over a joint force. See FMs 71-100, 100-15, 100-20, and JP 0-2.

joint force land component commander (JFLCC) (JP 1-02) — The commander within a unified command, subordinate unified command, or joint task force responsible to the establishing commander for making recommendations on the proper employment of land forces, planning and coordinating land operations, or accomplishing such operational missions as may be assigned. The joint force land component commander is given the authority necessary to accomplish missions and tasks assigned by the establishing commander. The joint force land component commander will normally be the commander with the preponderance of land forces and the requisite command and control capabilities. (See also land component commander (LCC).) See FMs 100-5, 100-15, 100-20, and 100-30.

joint force maritime component commander (JFMCC) (JP 1-02) — The commander within a unified command, subordinate unified command, or joint task force responsible to the establishing commander for making recommendations on the proper employment of maritime forces and assets, planning and coordinating maritime operations, or accomplishing such operational missions as may be assigned. The joint force maritime component commander is given the authority necessary to accomplish missions and tasks assigned by the establishing commander. The joint force maritime component commander will normally be the commander with the preponderance of maritime forces and the requisite command and control capabilities.

joint force special operations component commander (JFSOCC) (JP 1-02) — The commander within a unified command, subordinate unified command, or joint task force responsible to the establishing commander for making recommendations on the proper employment of special operations forces and assets, planning and coordinating special operations, or accomplishing such operational missions as may be assigned. The joint force special operations component commander is given the authority necessary to accomplish missions and tasks assigned by the establishing commander. The joint force special operations component commander will normally be the commander with the preponderance of special operations forces and the requisite command and control capabilities.

Joint Operation Planning and Execution System (JOPES) (JP 1-02) — A continuously evolving system that is being developed through the integration and enhancement of earlier planning and execution systems: Joint Operation Planning System and Joint Deployment System. It provides the foundation for conventional command and control by national- and theater-level commanders and their staffs. It is designed to satisfy their information needs in the conduct of joint planning and operations. Joint Operation Planning and Execution System (JOPES) includes joint operation planning policies, procedures, and reporting structures supported by communications and automated data processing systems. JOPES is used to monitor, plan, and execute mobilization, deployment, employment, and sustainment activities associated with joint operations. (See also joint operations.) See FM 101-5.

joint operations (JP 1-02) — A general term to describe military actions conducted by joint forces, or by Service forces in relationships (e.g., support, coordinating authority), which, of themselves, do not create joint forces. (Army) — Operations carried on by two or more of the armed forces. See FMs 100-5, 100-15, 100-20, and JP 0-2.

joint psychological operations task force (JPOTF) (Army) — A joint task force composed of psychological operations units from more than one service, formed to carry out a specific psychological operation or to prosecute psychological operations in support of a theater campaign or other operations. This joint task force may have conventional nonpsychological operations units under operational control, assigned, or attached to support the conduct of specific missions. It is subordinate to the joint task force and has a coequal position with the joint special operations task force, Army, Marine, Navy, and Air Force forces commanders. See FMs 33-1, 100-15, and 100-20.

OPERATIONAL TERMS AND GRAPHICS

joint special operations air component commander (JSOACC) (JP 1-02) —The commander within the joint force special operations command responsible for planning and executing joint special air operations and for coordinating and deconflicting such operations with conventional nonspecial operations air activities. The joint special operations air component commander normally will be the commander with the preponderance of assets and/or greatest ability to plan, coordinate, allocate, task, control, and support the assigned joint special operations aviation assets. The joint special operations air component commander may be directly subordinate to the joint force special operations component commander or to any nonspecial operations component or joint force commander as directed.

joint special operations area (Army) — That area of land, sea, and airspace assigned to a joint special operations command to conduct special operations. See FM 31-20.

joint special operations task force (JSOTF) (JP 1-02) — A joint task force composed of special operations units from more than one Service, formed to carry out a specific special operation or prosecute special operations in support of a theater campaign or other operations. The JSOTF may have conventional nonspecial operations units assigned or attached to support the conduct of specific missions. See FMs 71-100, 100-15, 100-20, and 100-25.

joint suppression of enemy air defenses (JSEAD) (JP 1-02) — A broad term that includes all suppression of enemy air defenses activities provided by one component of the joint force in support of another. (See also air defense suppression and suppression of enemy air defenses (SEAD).) See FMs 44-100 and 6-20 series.

joint task force (JTF) (JP 1-02) — A joint force that is constituted and so designated by the Secretary of Defense, a combatant commander, a subunified commander, or an existing joint task force commander. See FMs 100-5, 100-15, 100-20, and JP 0-2. **A-2**

joint unconventional warfare task force (JUWTF) (Army) — A force composed of unconventional warfare forces of two or more services which is constituted by the Secretary of Defense or by the commander of a unified command, a specified command, or an existing joint task force. (See also joint special operations task force (JSOTF) and joint psychological operations task force (JPOTF).) See FMs 100-5, 100-20, and 100-25.

K

key terrain (JP 1-02, NATO) — Any locality, or area, the seizure or retention of which affords a marked advantage to either combatant. (See also intelligence preparation of the battlefield (IPB).) See FM 34-130.

killed in action (KIA) (JP 1-02) — A casualty category applicable to a hostile casualty, other than the victim of a terrorist activity, who is killed outright or who dies as a result of wounds or other injuries before reaching a medical treatment facility. (See also casualty, died of wounds (DOW), hostile casualty, nonhostile casualty, and graves registration.) See FMs 8-10, 8-55, 10-63-1, 12-6, and 16-1.

L

land component commander (LCC) (Army) — The senior commander of a joint or multinational military force responsible for all aspects of operations for land maneuver and support forces. (See also joint force land component commander (JFLCC).) See FMs 1-111, 6-20, 7-20, 7-30, 17-95, 71-100, 71-123, 100-15, and 101-5.

landing area (JP 1-02) — **1.** The part of the objective area within which are conducted the landing operations of an amphibious force. It includes the beach, the approaches to the beach, the transport areas, the fire support areas, the air occupied by close supporting aircraft, and the land included in the advance inland to the initial objective. **2.** (Airborne) The general area used for landing troops and materiel either by airdrop or air landing. This area includes one or more drop zones or landing strips. **3.** Any specially prepared or selected surface of land, water, or deck designated or used for takeoff and landing of aircraft. (See also airhead, drop zone (DZ), landing zone (LZ) and objective.) See FMs 1-111, 7-8, 7-10, 7-20, 7-30, 31-12, 71-100-2, 71-100-3, 90-4, and 90-26.

landing beach (JP 1-02, NATO) — That portion of a shoreline usually required for the landing of a battalion landing team. However, it may also be that portion of a shoreline constituting a tactical locality (such as the shore of a bay) over which a force larger or smaller than a battalion landing team may be landed. (See also amphibious operation.) See FMs 31-12 and 71-100-2.

landing plan (JP 1-02) — In amphibious operations, a collective term referring to all individually prepared naval and landing force documents that, taken together, present in detail all instructions for execution of the ship-to-shore movement. (Army) — An airborne, air assault, or air movement plan prescribing the sequence, place of arrival, and method of entry into the objective area. The purpose of the plan is to get the correct units to the correct place in the correct order to properly execute the ground tactical plan. (See also ground tactical plan and marshalling plan.) See FMs 1-111, 7-8, 7-10, 7-20, 7-30, 31-12, 71-100-2, 71-100-3, 90-4, and 90-26.

landing point (JP 1-02, NATO) — A point within a landing site where one helicopter or vertical takeoff and landing aircraft can land. (See also air assault, landing site, and landing zone (LZ).) See FMs 1-111, 7-8, 7-10, 7-20, 7-30, 71-100-2, 71-100-3, 90-4, and 90-26.

landing site (JP 1-02, NATO) — **1.** A site within a landing zone containing one or more landing points. **2.** In amphibious operations, a continuous segment of coastline over which troops, equipment, and supplies can be landed by surface means. (Army) — A location where aircraft take off and land. See FM 71-100-2.

landing zone (LZ) (JP 1-02, NATO) — Any specified zone used for the landing of aircraft. (See also air assault and airhead.) See FMs 1-111, 7-8, 7-10, 7-20, 7-30, 31-12, 71-100-2, 71-100-3, 90-4, and 90-26. **3-13**

landing zone control party (JP 1-02, NATO) — Personnel specially trained and equipped to establish and operate communications devices from the ground for traffic control of aircraft/helicopters for a specific landing zone. (See also air assault.) See FMs 1-111, 7-8, 7-10, 7-20, 7-30, 71-100-2, 71-100-3, and 90-4.

lane — A route through an enemy or friendly obstacle that provides a passing force safe passage. The route may be reduced and proofed as part of a breach operation, or constructed as part of a friendly obstacle. It is a clear route that moves all the way through an obstacle. (See also gap.) See FMs 5-71-100, 5-101, 5-102, and 90-13-1. **3-28**

lane marker (JP 1-02, NATO) — In land mine warfare, sign used to mark a minefield lane. Lane markers, at the entrance to and exit from the lane may be referenced to a landmark or intermediate marker. (See also breach, gap, and lane.) See FMs 5-71-100, 5-101, 5-102, 90-13-1.

lapse — A marked decrease in air temperature with increasing altitude because the ground is warmer than the surrounding air. This condition usually occurs between 1100 and 1600 hours, local time, when skies are clear. Strong convection currents exist during lapse conditions. For chemical operations, the state

OPERATIONAL TERMS AND GRAPHICS

is defined as unstable and is normally considered the most unfavorable for the release of chemical agents. (See also inversion and neutral.) See FM 3-6.

large-scale map — *See* map.

latent (nuclear) ineffectiveness — **1.** The minimum exposure that will result in the average service member becoming performance-degraded within three hours and remaining so until death. **2.** The minimum exposure that will result in the average service member becoming combat ineffective at any time within six weeks of postexposure. See FMs 8-10-7, 100-30, JPs 3-12.2, and 3-12.3.

lateral boundaries — Control measures that define the left and right limits of a unit's zone of action or sector. Together with the rear and forward boundaries and a coordinating altitude, lateral boundaries define the area of operations for a commander. See FMs 1-111, 6-20, 7-20, 7-30, 17-95, 71-100, 71-123, 100-15, and 101-5. **3-11**

lateral route (JP 1-02, NATO) — A route generally parallel to the forward edge of the battle area, which crosses, or feeds into, axial routes. (See also main supply route (MSR), alternate supply route (ASR), and air corridor.) See FMs 1-111, 10-1, 63-2, 63-2-1, 63-6, 63-20, 63-21, and 71-100-3.

lateral spread (JP 1-02) — A technique used to place the mean point of impact of two or more units 100 meters apart on a line perpendicular to the gun-target line. See FM 6-40.

latest time information is of value — The time by which an intelligence organization or staff must deliver information to the requestor in order to provide decision makers with timely intelligence. This must include the time anticipated for processing and disseminating that information as well as for making the decision. See FMs 34-1 and 34-130.

law and order operations — A military police mission that includes law enforcement, criminal investigation, and the confinement of US military prisoners. Law and order operations are conducted only when the combat commander requires it and when battle intensity permits. See FM 19-10.

law of war (JP 1-02) — That part of international law that regulates the conduct of armed hostilities. Also called the law of armed conflict. (See also rules of engagement (ROE) and rules of interaction (ROI).) See FM 27-10.

lay (JP 1-02) — **1.** Direct or adjust the aim of a weapon. **2.** Setting of a weapon for a given range, or for a given direction, or both. **3.** To drop one or more aerial bombs or aerial mines onto the surface from an aircraft. **4.** To spread a smoke screen on the ground from an aircraft. **5.** To calculate or project a course. **6.** To lay on: a. to execute a bomber strike; b. to set up a mission. See FMs 6-series and 7-90.

least separation distance (LSD) — The minimum distance that a desired ground zero must be separated from an object to ensure no more than a 10 percent chance of damage with a 99 percent assurance. It is the sum of the radius of preclusion and the buffer distance. See FM 100-30.

lewisite— A blister agent (an arsenical vesicant) used as a moderately delayed-action casualty agent with a persistency somewhat shorter than HD (distilled mustard). It produces effects similar to mustard, although, unlike mustard, it produces immediate pain. See FM 3-9.

liaison (NATO) — That contact or intercommunication maintained between elements of military forces to ensure mutual understanding and unity of purpose and action. See FM 101-5.

liberated territory (JP 1-02, NATO) — Any area, domestic, neutral, or friendly, which, having been occupied by an enemy, is retaken by friendly forces.

lift — All helicopters assigned to a particular mission to move troops, supplies, and equipment. (See also chalk and air assault.) See FMs 1-111, 7-8, 7-10, 7-20, 7-30, 71-100-2, 71-100-3 and 90-4.

lift fire — In direct fire, the command to raise the cone of fire so that the beaten zone strikes the target, but the space between the target and the firing weapons is safe for maneuver by friendly forces. See FMs 17-12 and 23-1.

light line (LL) (JP 1-02, NATO) — A designated line forward of which vehicles are required to use black-out lights at night. See FMs 1-111, 6-20, 7-20, 7-30, 17-95, 71-123, 71-100, 100-15, and 101-5. **3-26**

limit of advance (LOA) — An easily recognized terrain feature beyond which attacking elements will not advance. (See also probable line of deployment (PLD) and final coordination line (FCL).) See FMs 1-112, 7-7, 7-8, 7-10, 7-20, 7-30, 17-15, 17-95, and 71-123. **3-17**

limitation — **1.** Control measure, instruction, or order that restricts freedom of action. **2.** An action, activity, or task that a unit is not capable of executing. This condition may be due to natural reasons such as terrain and weather or reasons such as training or equipment.

limited access route (JP 1-02, NATO) — A one way route with one or more restrictions which preclude its use by the full range of military traffic. (See also main supply route (MSR) and alternate supply route (ASR).) See FM 55-2.

limited visibility operations — Operations conducted at night and during other periods of reduced visibility. (See also limit of advance (LOA), probable line of deployment (PLD), and final coordination line (FCL).) See FMs 1-112, 7-7, 7-8, 7-10, 7-20, 7-30, 17-15, 17-95, and 71-123.

limit of fire (JP1-02, NATO) — **1.** The boundary marking off the area on which gunfire can be delivered. **2.** Safe angular limits for firing at aerial targets. (Army) — Tactical markers used to define the sector of fire for an individual soldier, a weapon system, or a unit that prevents fratricide of adjacent units and focuses fires to kill the enemy. (See also final protective line (FPL), target reference point (TRP), and engagement area (EA).) See FMs 1-112, 7-7, 7-8, 7-10, 7-20, 17-15, and 71-123.

line (JP 1-02, NATO) — In artillery and naval gunfire support, a spotting, or an observation, used by a spotter or an observer to indicate that a burst(s) occurred on the spotting line. (Army) — Pertains to mortar fires also. See FMs 6-series and 7-90.

line of contact (LC) — A general trace delineating the location where two opposing forces are engaged. (See also forward edge of the battle area (FEBA), forward line of own troops (FLOT), line of departure (LD), and line of departure is line of contact (LD/LC).) See FMs 1-112, 7-7, 7-8, 7-10, 7-20, 7-30, 17-15, 17-95, and 71-123. **3-13**

line of demarcation (LOD) — A line defining the boundary of a buffer zone or an area of limitation. A line of demarcation may also be used to define the forward limits of disputing or belligerent forces after each phase of disengagement or withdrawal has been completed.

line of departure (LD) (JP 1-02, NATO) — **1.** In land warfare, a line designated to coordinate the departure of attack elements. **2.** In amphibious warfare, a suitably marked offshore coordinating line to assist assault craft to land on designated beaches at scheduled times. (See also line of contact (LC) and line of

OPERATIONAL TERMS AND GRAPHICS ---

departure is line of contact (LD/LC).) See FMs 1-111, 7-7, 7-8, 7-10, 7-20, 7-30, 17-15, 17-95, 31-12, and 71-123. **3-17**

line of departure is line of contact (LD/LC) — The designation of forward friendly positions as the LD when opposing forces are in contact. (See also line of contact (LC) and line of departure (LD).) See FMs 1-111, 7-7, 7-8, 7-10, 7-20, 7-30, 17-15, 17-95, and 71-123. **3-17**

line formation — An arrangement of vehicles or personnel in which elements are arranged abreast of each other. This formation permits maximum fire to front or rear and a minimum of fire to the flanks. (See also formation, movement formation, echelon formation, and column formation.) See FMs 1-112, 7-7, 7-8, 7-10, 7-20, 7-30, 17-15, 17-95, and 71-123.

line haul — In highway transportation, a type of haul involving long trips over the road in which the portion of driving time is high in relation to the time consumed in loading and unloading. Line haul usually involves one trip or a portion of a trip per operating shift of 10 hours, or 2 trips per day. See FMs 55-2 and 55-10.

lines of communications (LOC) (JP 1-02) — All the routes, land, water, and air, which connect an operating military force with a base of operations and along which supplies and military forces move. (See also communications zone (COMMZ).) See FMs 10-1, 100-5, 100-7, 100-10, and 100-15.

line of sight (LOS) — The unobstructed path from a soldier, weapon, weapon sight, electronic-sending and -receiving antennas, or piece of reconnaissance equipment from one point to another. (See also intervisibility (IV).) See FMs 1-111, 7-7, 7-8, 7-10, 7-20, 7-30, 17-15, 17-95, 71-100, 71-123, 100-15, and 100-20.

linkup — A meeting of friendly ground forces (such as when an advancing force reaches an objective area previously seized by an airborne or air assault force, when an encircled element breaks out to rejoin friendly forces, or when converging maneuver forces meet). (See also linkup point.) See FMs 1-111, 7-7, 7-8, 7-10, 7-20, 7-30, 17-15, 17-95, 71-100, 71-123, 100-15, and 100-20.

linkup point — An easily identifiable point on the ground where two forces conduct a linkup meet. When one force is stationary, linkup points normally are established where the moving force's routes of advance intersect the stationary force's security elements. Linkup points for two moving forces are established on boundaries where the two forces are expected to converge. (See also air assault, airborne operation, breakout, and linkup.) See FMs 1-111, 7-7, 7-8, 7-10, 7-20, 7-30, 17-15, 17-95, 31-20, 71-100, 71-100-3, 71-123, 90-4, 90-26, 100-15, and 100-20. **3-26**

list of targets (JP 1-02) — A tabulation of confirmed or suspect targets maintained by any echelon for informational and fire support planning purposes. (See also fire plan and target list.) See FMs 6-20 series and 101-5.

load plan — A document which presents in detail all instructions for the arrangement of personnel and equipment aboard a given type aircraft or vehicle. (See also combat loading.) See FMs 7-8, 55-12, and 71-10.

local haul — In highway transportation, a type of haul characterized by short driving time in relation to loading and unloading time and normally involves four or more trips per day. See FMs 55-2 and 55-10.

local security — Those security elements established near a unit to prevent surprise by the enemy. See FMs 1-111, 7-7, 7-8, 7-10, 7-20, 7-30, 17-15, 17-95, 71-100, 71-123, 100-15, and 100-20.

lock on (JP 1-02, NATO) — Signifies that a tracking or target-seeking system is continuously and automatically tracking a target in one or more coordinates (e.g., range, bearing, elevation).

lodgment area (JP 1-02) — *See* airhead; beachhead. (Army) — A designated area or hostile or potentially hostile territory that, when seized and held, ensures the continuous landing (buildup) of troops and materiel and provides sufficient maneuver space for buildup of combat power to resolve the crises rapidly and decisively. (See also airhead, beachhead, and opposed entry.) See FMs 1-111, 7-7, 7-8, 7-10, 7-20, 7-30, 17-15, 17-95, 71-100, 71-100-2, 71-100-3, 71-123, 100-15, and 100-20.

log crib — A type of point obstacle used as a roadblock where such an obstacle cannot be readily bypassed. (See also abatis, point obstacle, road block, and cratering charge.) See FMs 5-34, 5-71-100, and 5-102.

log hurdle — A type of point obstacle used to slow tracked vehicles and make them more vulnerable to antitank fires or make the tracked vehicles vulnerable to "belly shots" as they climb over the hurdles. (See also abatis, point obstacle, road block, and cratering charge.) See FMs 5-34, 5-71-100, and 5-102.

logistics (JP 1-02, NATO) — The science of planning and carrying out the movement and maintenance of forces. In its most comprehensive sense, those aspects of military operations which deal with: **a.** design and development, acquisition, storage, movement, distribution, maintenance, evacuation, and disposition of materiel; **b.** movement, evacuation, and hospitalization of personnel; **c.** acquisition or construction, maintenance, operation, and disposition of facilities; and **d.** acquisition or furnishing of services. (See also combat service support (CSS).) See FMs 10-1 and 100-10.

logistics assault base (LAB) (Army) — A temporary logistics support area transported across enemy lines via helicopter to support extended deep air assault operations and raids. If the LAB is to become a permanent facility, the unit must develop it into a forward operations base. See FM 71-100-3.

logistics base — A principal or supplementary base of support; a locality containing installations which provide logistic or support.

logistics package (LOGPAC) — A grouping of multiple classes of supplies and supply vehicles under the control of a single convoy commander. Daily LOGPACs contain a standardized allocation of supplies. Special LOGPACs can also be dispatched as needed. See FM 71-123.

logistics preparation of the battlefield (Army) — All actions taken by combat service support to maximize the means of supporting commander's plans.

logistics over the shore (LOTS) — The loading and unloading of ships without the benefit of fixed port facilities, in friendly or undefended territory, and, in time of war, during phases of theater development in which there is no enemy opposition.

logistics release point (LRP) — **1.** The point along the supply route where the unit first sergeant or unit guide takes control of a company logistics package (LOGPAC). **2.** The point along the supply route where the supported unit meets the supporting unit to transfer supplies. See FM 55-30. **3-38**

log posts — A type of point obstacle with posts placed in belts and combined with wire and usually used as a road block or turning obstacle. To breach a belt of log posts requires an extensive breaching effort. (See also abatis, cratering charge, point obstacle, and road block.) See FMs 5-34, 5-71-100, and 5-102.

OPERATIONAL TERMS AND GRAPHICS

long-range surveillance (LRS) — Surveillance of an enemy force or a specified area over extended distances using long-range surveillance units; special operations forces; division, corps, theater, or national monitoring devices; or any combination of these to provide information to the commander.

lost (JP 1-02, NATO) — In artillery and naval gunfire support, a spotting, or an observation used by a spotter or an observer to indicate that rounds fired by a gun or mortar were not observed. (Army)—Pertains to mortar and direct fire gunnery also. See FM 6-series, 7-90, 7-91, 17-12, and 23-1.

low-altitude parachute extraction system (LAPES) (Army) — A low-level, self-contained extraction system capable of delivering heavy equipment or supplies via aircraft to a specified extraction zone (EZ) from an altitude of 5 to 10 feet above ground level when air landing is not feasible. See FMs 7-7, 7-10, 7-20, 7-30, 71-100-2, and 90-26.

low-level transit route (LLTR) (JP 1-02, NATO) — A temporary corridor of defined dimensions established in the forward area to minimize the risk to friendly aircraft from friendly air defenses or surface forces. (See also minimum-risk route (MRR), air corridor, and flight corridor.) See FM 100-103. **3-5**

M

magnetic azimuth — An angle of direction measured clockwise from magnetic north. (See also azimuth, grid of azimuth, and true azimuth.) See FM 21-26.

magnetic declination (JP 1-02, NATO) — The angle between the magnetic and geographical meridians at any place, expressed in degrees east or west to indicate the direction of magnetic north from true north. In nautical and aeronautical navigation, the term magnetic variation is used instead of magnetic declination and the angle is termed variation of the compass or magnetic variation. Magnetic declination is not otherwise synonymous with magnetic variation which refers to regular or irregular change with time of the magnetic declination, dip, or intensity. See FM 21-26.

magnetic variation (JP 1-02, NATO) — **1.** In navigation, at a given place and time, the horizontal angle between the true north and magnetic north measured east or west according to whether magnetic north lies east or west of true north. (See also magnetic declination.) **2.** In cartography, the annual change in direction of the horizontal component of the Earth's magnetic field. See FM 21-26.

main attack (JP 1-02, NATO) — The principal attack or effort into which the commander throws the full weight of the offensive power at his disposal. An attack directed against the chief objective of the campaign or battle. (Army) — The primary mission in support of the higher commander's main effort. It is weighted with combat, combat support, and combat service support. The higher commander will normally support the main attack with a supporting attack(s) and other operations such as deep attacks, electronic warfare (EW) operations, deception operations, and economy of force operations. (See also main effort, supporting attack, deception operation, and attack.) See FMs 1-111, 6-20, 7-20, 7-30, 17-95, 71-100, 71-123, 100-15, and 101-5. **3-15, 3-16**

main battle area (MBA) (JP 1-02) — That portion of the battlefield in which the decisive battle is fought to defeat the enemy. For any particular command, the main battle area extends rearward from the forward edge of the battle area to the rear boundary of the command's subordinate units. (See also defensive operations, forward edge of the battle area (FEBA), and handover line.) See FMs 1-111, 6-20, 7-20, 7-30, 17-95, 71-100, 71-123, 100-15, and 101-5.

main body — **1.** The principal part of a tactical command or formation. It does not include detached elements of the command such as advance guards, flank guards, and covering forces. **2.** In a motor column, all vehicles exclusive of the column head, trail, and control vehicles which consist primarily of the vehicles carrying the bulk of the cargo or troops within the column. See FMs 1-111, 6-20, 7-20, 7-30, 17-95, 71-100, 71-123, 100-15, and 101-5.

main command post — A cell that includes those staff activities involved in controlling and sustaining current operations and in planning future operations. The main command post (CP) normally operates under control of the chief of staff. In addition to the chief of staff, the main CP consists of G1, G2, G3, and G4 elements; fire support and chemical elements, tactical air control party element, and an Army airspace command and control element consisting of air defense artillery and Army aviation staff elements. The main CP exercises command and control of the current operation in cases where a tactical CP is not employed. (See also command post (CP); rear command post; tactical command post (TAC CP).) See FMs 1-111, 6-20, 7-20, 7-30, 17-95, 71-100, 71-123, 100-15, and 101-5. **A-3**

main effort (Army) — The unit, battle position, sector, zone, axis, avenue of approach, area of operations, theater of operations, and so forth, the senior commander has determined has the most important task and purpose at that time, whose success will make the most difference in the accomplishment of the higher commander's overall mission or objective. Commanders at all levels should designate a point of main effort along with supporting efforts. This helps them and their staffs to allocate resources accordingly, providing focus to the operation while setting priorities and determining risks, promoting unity of effort, and facilitating and understanding of the commander's intent. There is only one main effort at any time in the operation, although the main effort may change as the situation changes to take advantage of opportunities or to avert failure. In the offense, the commander will conduct the main attack where the main effort has been designated. The unit(s) conducting the main attack normally will shift throughout the operation. The main attack may be a deep attacking unit, the point unit of the ground attack, or the reserve, when committed. In the defense, the main effort is that area along the enemy avenue of approach that the defense depends on for success. The higher commander will influence the main effort with supporting effort(s). For example, during World War II the European Theater was the national main effort and the Pacific theater was a supporting effort. (See also main attack and supporting effort.) See FMs 1-111, 6-20, 7-20, 7-30, 17-95, 71-100, 71-123, 100-5, 100-15, and 101-5.

main line of resistance (JP 1-02) — A line at the forward edge of the battle position, designated for the purpose of coordinating the fire of all units and supporting weapons, including air and naval gunfire. It defines the forward limits of a series of mutually supporting defensive areas, but it does not include the areas occupied or used by covering or screening forces.

main operations base (MOB) (JP 1-02) — In special operations, a base established by a joint force special operations component commander or a subordinate special operations component commander in friendly territory to provide sustained command and control, administration, and logistical support to special operations activities in designated areas. (See also advanced operations base (AOB) and forward operations base (FOB).) See FM 100-25.

main supply route (MSR) (JP 1-02, NATO) — The route or routes designated within an area of operations upon which the bulk of traffic flows in support of military operations. **3-40**

maintenance (materiel) (JP 1-02) — **1.** All action taken to retain materiel in a serviceable condition or to restore it to serviceability. It includes inspection, testing, servicing, classification as to serviceability, repair, rebuilding, and reclamation. **2.** All supply and repair action taken to keep a force in condition to carry out its mission. **3.** The routine recurring work required to keep a facility (plant, building,

OPERATIONAL TERMS AND GRAPHICS

structure, ground facility, utility system, or other real property) in such condition that it may be continuously used, at its original or designed capacity and efficiency for its intended purpose. **4-26**

maintenance collection point (MCP) — A point established to collect equipment awaiting repair, controlled exchange, cannibalization, or evacuation. It may be operated by the user or by direct support maintenance units. (See also unit maintenance collection point (UMCP).) **3-38**

maintenance status (JP 1-02) — **1.** A nonoperating condition, deliberately imposed, with adequate personnel to maintain and preserve installations, materiel, and facilities in such a condition that they may be readily restored to operable condition in a minimum time by the assignment of additional personnel and without extensive repair or overhaul. **2.** That condition of materiel which is in fact, or is administratively classified as, unserviceable, pending completion of required servicing or repairs. (Army) — A condition of materiel readiness that reports the level of operational readiness for a piece of equipment. See FM 63-2.

maintenance support team (MST) — A tailored direct support team that colocates with a unit maintenance element for a designated period. See FM 63-2.

major disaster — See domestic emergencies.

major operation (Army) — The coordinated actions of large forces in a single phase of a campaign. A major operation could contain a number of battles or could be a single critical battle.

mandate — A resolution approved by the United Nations Security Council or United States government that delineates the objective, the resources, role, and tasks of the force assigned to carry out the resolution. It also includes the terms of reference which should include the rules of engagement, rules of interaction, force protection, geographical limitations, limits on the duration of the operation, relationships with belligerent parties, relationships with humanitarian assistance organizations, personnel resources, and financing. (See also counterdrug (CD), counterinsurgency, humanitarian assistance (HA), peace operations, and stability and support operations (SASO). See FMs 100-20 and 100-23.

maneuver (JP 1-02, NATO) — **1.** A movement to place ships or aircraft in a position of advantage over the enemy. **2.** A tactical exercise carried out at sea, in the air, on the ground, or on a map in imitation of war. **3.** The operation of a ship, aircraft, or vehicle, to cause it to perform desired movements. **4.** Employment of forces on the battlefield through movement in combination with fire, or fire potential, to achieve a position of advantage in respect to the enemy in order to accomplish the mission. (Army) — Employment of forces on the battlefield through movement of combat forces in relation to the enemy, supported by fire or fire potential from all sources, to gain potential advantage from which to destroy or threaten destruction of the enemy to accomplish the mission. See FMs 100-5 and 100-40.

manifest (JP 1-02) — A document specifying in detail the passengers or items carried for a specific destination.

manipulative electromagnetic deception (MED) (JP 1-02) — Actions to eliminate revealing, or convey misleading, electromagnetic telltale indicators that may be used by hostile forces. (See also electronic warfare (EW), electromagnetic deception, imitative electromagnetic deception, and simulative electromagnetic deception.) See FM 34-40.

map (JP 1-02, NATO) — A graphic representation, usually on a plane surface, and at an established scale, of natural or artificial features on the surface of a part or whole of the Earth or other planetary body. These features are positioned relative to a coordinate reference system. See FM 21-26. (Army) —

a. large-scale map. A map having a scale of 1:75,000 or larger used for tactical planning. **b. medium-scale map.** A map having a scale between 1:1,000,000 and 1:75,000 used for operational planning. **c. small-scale map.** A map having a scale smaller than 1:1,000,000 used for general planning and strategic studies.

march column — A group of two to five serials using the same route for a single movement, organized under a single commander for planning, regulating, and controlling. (See also march serial, march unit, and movement order.) See FMs 55-30 and 101-5.

march serial — A subdivision of a march column consisting of a group of two to five march units using the same route for a single movement, organized under a single commander for planning, regulating, and controlling. (See also march column, march unit, and movement order.) See FMs 55-30 and 101-5.

march unit — The smallest subdivision of a march column; a group of normally no more than 25 vehicles using the same route for a single movement, organized under a single commander for planning, regulating, and controlling. (See also march column, march serial, and movement order.) See FMs 55-30 and 101-5.

Marine air-ground task force (MAGTF) (JP 1-02) — A task organization of Marine forces (division, aircraft wing, and service support groups) under a single command and structured to accomplish a specific mission. The MAGTF components will normally include command, aviation combat, ground combat, and combat service support elements (including Navy Support Elements). Three types of MAGTFs that can be task organized are the Marine expeditionary unit, Marine expeditionary brigade, and Marine expeditionary force. The four elements of a Marine air-ground task force are command element (CE), aviation combat element (ACE), ground combat element (GCE), and combat service support element (CSSE). (See also aviation combat element (ACE), combat service support element (CSSE), command element (CE), ground combat element (GCE), Marine expeditionary force (MEF), Marine expeditionary force (forward) (MEF (FWD)), Marine expeditionary unit (MEU), and task force.)

Marine expeditionary force (MEF) (JP 1-02) — The Marine expeditionary force, the largest of the Marine air-ground task forces, is normally built around a division/wing team, but can include several divisions and aircraft wings, together with an appropriate combat service support organization. The Marine expeditionary force is capable of conducting a wide range of amphibious assault operations and sustained operations ashore. It can be tailored for a wide variety of combat missions in any geographic environment. (See also Marine air-ground task force (MAGTF), Marine expeditionary force (forward) (MEF(FWD)), and Marine expeditionary unit (MEU).) See JP 3-02.1.

Marine expeditionary force (forward) (MEF(FWD)) — A task organization which is normally built around a regimental landing team, a provisional Marine aircraft group, and a logistics support group; a brigade-sized unit which has been designated as the forward echelon of a Marine Expeditionary Force (MEF). It can deploy as an air contingency force, a maritime or geographic prepositioning force, or the landing force of an amphibious operation. It normally can sustain operations for 30 days while the follow-on forces of the MEF are being deployed. (See also Marine air-ground task force (MAGTF), Marine expeditionary force (MEF), and Marine expeditionary unit (MEU).) See JP 3-02.1.

Marine expeditionary unit (MEU) (JP 1-02) — A task organization which is normally built around a battalion landing team, reinforced helicopter squadron, and logistic support unit. It fulfills routine forward afloat deployment requirements, provides an immediate reaction capability for crisis situations, and is capable of relatively limited combat operations. (See also Marine air-ground task force (MAGTF), Marine expeditionary force (MEF), and Marine expeditionary force (forward) (MEF (FWD)).) See JP 3-02.1.

OPERATIONAL TERMS AND GRAPHICS

marking smoke — Smoke employed to relay prearranged communications on the battlefield. It is frequently used to identify targets, evacuation points, friendly perimeters, and so forth. See FM 3-50.

marshalling (JP 1-02, NATO) — **1.** The process by which units participating in an amphibious or airborne operation group together or assemble when feasible or move to temporary camps in the vicinity of embarkation points, complete preparations for combat, or prepare for loading. **2.** The process of assembling, holding, and organizing supplies and/or equipment, especially vehicles of transportation, for onward movement. (See also staging area.) See FMs 71-100-3 and 90-26.

marshalling area — **1.** The general area in which unit preparation areas and departure airfields may be located and from which movement is initiated. **2.** An area located adjacent to strategic air and sea ports of embarkation and debarkation, controlled by the Army service component commander, in which units configure forces, sustainment, and material for onward movement to staging areas or tactical assembly areas. **3.** In amphibious operations, the designated area in which, as part of the mounting process, units are reorganized for embarkation; vehicles and equipment are prepared to move directly to embarkation areas; and housekeeping facilities are provided for troops by other units. See FM 100-17.

marshalling plan — An airborne operational plan by which units of the force complete final preparation for combat, move to departure airfields, and load for take-off. It begins when elements of the force are literally "sealed" in marshalling areas and terminates at loading. (See also ground tactical plan and landing plan.) See FMs 100-17 and 101-5.

mask only — **1.** A protective measure that provides some relief from mission-oriented protective posture (MOPP) gear for personnel who must work in a vapor- or aerosol-contaminated environment. Personnel must be within protective shelters (certain types of vans, tanks, or buildings) where the danger of transfer hazards is minimal. This posture is only used when the only threat is vapor. Mask only cannot be used when blister agents are present. **2.** A protective measure preparation used when the commander anticipates that his only chemical threat is from riot control agents. (See also mission-oriented protective posture (MOPP).) See FM 3-4.

mass(JP 1-02, NATO) — **1.** The concentration of combat power. **2.** The military formation in which units are spaced at less than the normal distances and intervals. (Army) — To concentrate or bring together fires, as to mass fires of multiple weapons or units. (See also principles of war.) See FM 100-5.

mass casualty (JP 1-02) — Any large number of casualties produced in a relatively short period of time, usually as the result of a single incident such as a military aircraft accident, hurricane, flood, earthquake, or armed attack that exceeds local logistical support capabilities. (See also casualty.)

massed fire (JP 1-02) — **1.** The fire of the batteries of two or more ships directed against a single target. **2.** Fire from a number of weapons directed at a single point or small area. (See also concentrated fire.)

materiel release confirmation (JP 1-02) — A notification from a shipping/storage activity advising the originator of a materiel release order of the positive action taken on the order. It will also be used with appropriate shipment status document identifier codes as a reply to a follow-up initiated by the inventory control point.

materiel release order (JP 1-02) — An order issued by an accountable supply system manager (usually an inventory control point or accountable depot/stock point) directing a nonaccountable activity (usually a storage site or materiel drop point) within the same supply distribution complex to release and ship materiel.

maximum effective range (JP 1-02, NATO) — The maximum distance at which a weapon may be expected to be accurate and achieve the desired result. (Army) — The distance from a weapon system at which a 50 percent probability of target hit is expected, or the tracer burnout range. See FMs 6-series, 7-90, 7-91, 17-12, and 23-1.

maximum range (JP 1-02, NATO) — The greatest distance a weapon can fire without consideration of dispersion. (Army) — The maximum distance a projectile or rocket can go at the optimum elevation of the weapon. See FMs 6-series, 7-90, 7-91, 17-12, and 23-1.

maximum rate of fire — The largest quantity of rounds physically or mechanically possible to fire through a weapon or weapon system in a specified period of time regardless of the damage that could be done to the system if this number of rounds was fired for a prolonged period of time. (See also sustained rate of fire.) See FMs 6-series, 7-90, 7-91, 17-12, and 23-1.

M-day(JP 1-02) — The term used to designate the unnamed day on which full mobilization commences or is due to commence.

meaconing(JP 1-02, NATO) — A system of receiving radio beacon signals and rebroadcasting them on the same frequency to confuse navigation. The meaconing stations cause inaccurate bearings to be obtained by aircraft or ground stations.

meaconing, interference, jamming, and intrusion (MIJI) report — A report to record and report interference experienced with communications which was not determined to be caused by locally generated spurious signals or technical difficulties. This report is prepared based on an interference report forwarded from the unit or element that initially experienced the interference. The unit-level interference report is transmitted by the fastest and most secure means available. See FM 34-40.

medical care echelon — Describes the five levels of treatment within the military system. Each echelon has the same capabilities as the echelon before it, but adds a new treatment capability that distinguishes it from the previous echelon. The five echelons are: Echelon I - unit level or immediate lifesaving measures; Echelon II - a medical unit that adds dental, laboratory, x-ray, and patient holding capability; Echelon III - mobile army surgical hospitals and combat support hospitals that add the capability to perform surgery; Echelon IV - general hospitals and field hospitals that add staffing and equipment for general and specialized medical and surgical treatment; Echelon V - continental United States-based hospitals that can provide the most specialized and long-term care possible. See FMs 8-10, 8-10-1, 8-10-4, 8-10-14, 8-10-24, 8-51, and 8-55.

medical evacuation (MEDEVAC) — The timely and efficient movement of patients while providing *en route* medical care to and between medical treatment facilities. See FMs 8-10 and 8-10-6.

medical evacuees (JP 1-02) — Personnel who are wounded, injured, or ill and must be moved to or between medical facilities. See FMs 8-10, 8-10-1, 8-10-4, 8-10-14, 8-10-24.

medical threat (Army) — The composite of all ongoing or potential enemy actions and environmental conditions that reduce the performance effectiveness of the soldier. The soldier's reduced effectiveness results from sustained wounds, injuries, or diseases. See FMs 8-10, 8-10-8, 8-55.

medical treatment facility (MTF) (JP 1-02) — A facility established for the purpose of furnishing medical and/or dental care to eligible individuals. See FMs 8-10, 8-10-1, 8-10-4, 8-10-14, 8-10-24. **4-26, D-9**

OPERATIONAL TERMS AND GRAPHICS

medical waste — Any waste that is generated in the diagnosis, treatment, or immunization of human beings or animals.

medium-scale map — *See* map.

meeting engagement (JP 1-02, NATO) — A combat action that occurs when a moving force, incompletely deployed for battle, engages an enemy at an unexpected time and place. (Army) — The enemy force may be either stationary or moving. (See also movement to contact.) See FMs 1-111, 6-20, 7-20, 7-30, 17-95, 71-100, 71-123, 100-15, 100-40, and 101-5.

military art (Army) — The judgmental application of military science to the conditions at hand. Such judgment depends on knowledge in great depth which goes beyond a knowledge of mechanical factors and force ratios. It depends on inspired and skillful application of sound scientific approaches and demands the application of sound judgment in the weighting of the intangibles.

military chemical compound — Chemical substance that has become generally accepted by the public for use in conventional war. Included are riot control agents, flame and smoke materials, and military herbicides. Excluded are chemical agents. See FM 3-9.

military crest — An area on the forward or reverse slope of a hill or ridge just below the topographical crest from which maximum observation and direct fire covering the slope down to the base of the hill or ridge can be obtained. (See also topographical crest.) See FM 21-26.

military grid reference system (JP 1-02, NATO) — A system which uses a standard-scaled grid square, based on a point of origin on a map projection of the surface of the Earth in an accurate and consistent manner to permit either position referencing or the computation of direction and distance between grid positions. See FM 21-26.

military information environment (MIE) — Those individuals, organizations, and systems within the global information environment (GIE), both friendly and hostile, military and nonmilitary, that support, enable, or significantly influence a specific military operation. See FM 100-6.

military load classification (MLC) (JP 1-02, NATO) — A standard system in which a route, bridge, or raft is assigned class number(s) representing the load it can carry. Vehicles are also assigned number(s) indicating the minimum class of route, bridge, or raft they are authorized to use. (See also route classification.) See FMs 5-36 and 17-95.

military operations in a built-up area (MOBA) (Army) — All military actions planned and conducted on a topographical complex and its adjacent natural terrain where man-made construction is the dominant feature. It includes combat in cities, which is that portion of military operations on urbanized terrain involving house-to-house and street-by-street fighting in towns and cities. See FMs 90-10 and 90-10-1.

military operations on urbanized terrain (MOUT) — All military actions planned and conducted on a topographical complex and its adjacent natural terrain where man-made construction is the dominant feature. It includes combat-in-cities, which is that portion of MOUT involving house-to-house and street-by-street fighting in towns and cities. See FMs 90-10 and 90-10-1.

military operations other than war (MOOTW) (JP 1-02) — Operations that encompass the use of military capabilities across the range of military operations short of war. These military actions can be applied to complement any combination of the other instruments of national power and occur before,

during, and after war. (See also counterdrug (CD), counterinsurgency, domestic emergencies, humanitarian assistance (HA), and peace operations.) See FM 100-20 and JP 3-07.

military police response forces (Army) — Those forces the commander assigns the mission of responding to and conducting operations to close with and destroy or delay attacking enemy forces beyond the capabilities of base defenses (Level II). See FM 19-1.

military science (Army) — A systemized knowledge of the principles of war; the systematic development, examination, and dissemination of appropriate methods; and the systematic development, examination, and understanding of capabilities.

military strategy (JP 1-02) — The art and science of employing the armed forces of a nation to secure the objectives of national policy by the application of force or the threat of force. See FM 100-5.

minefield (JP 1-02, NATO) — In land warfare, an area of ground containing mines laid with or without a pattern. **3-30**

minefield breaching (JP 1-02, NATO) — In land mine warfare, the process of clearing a lane through a minefield under tactical conditions. (See also breach, in-stride breach, deliberate breach, covert breach, and lane.) See FMs 5-71-100, 5-101, and 90-13-1.

minimum range (JP 1-02) — **1.** Least range setting of a gun at which the projectile will clear an obstacle or friendly troops between the gun and the target. **2.** Shortest distance to which a gun can fire from a given position. (Army) — The range at which a projectile or fuse will be armed. See FMs 6-series, 7-90, 7-91, 17-12, and 23-1.

minimum-risk route (MRR) (JP 1-02) — A temporary corridor of defined dimensions recommended for use by high-speed, fixed-wing aircraft that presents the minimum known hazards to low-flying aircraft transiting the combat zone. (Army) — The MRR must be approved by the airspace control authority and avoids artillery, air defense weapons, landing zones, pick-up zones, forward arming and refueling points, and Army airfields. See FM 100-103. **3-5**

minimum safe distance (MSD) — The minimum distance in meters from desired ground zero at which a specific degree of personnel risk and vulnerability will not be exceeded with a 99 percent assurance. The MSD is the sum of the radius of safety and the buffer distance. (See also desired ground zero (DGZ), least separation distance (LSD), and troop safety (nuclear).) See FM 100-30 and JP 3-12.2. **3-34**

misfire (JP 1-02, NATO) — **1.** Failure to fire or explode properly. **2.** Failure of a primer or the propelling charge of a round or projectile to function wholly or in part. See FMs 6-series, 7-90, 7-91, 17-12, and 23-1.

missing (JP 1-02) — A casualty status for which the United States Code provides statutory guidance concerning missing members of the Military Services. Excluded are personnel who are in an absent without leave, deserter, or dropped-from-rolls status. A person declared missing is categorized as follows: **a. beleaguered** — The casualty is a member of an organized element that has been surrounded by a hostile force to prevent escape of its members. **b. besieged** — The casualty is a member of an organized element that has been surrounded by a hostile force for compelling it to surrender. **c. captured** — The casualty has been seized as the result of action of an unfriendly military or paramilitary force in a foreign country. **d. detained** — The casualty is prevented from proceeding or

OPERATIONAL TERMS AND GRAPHICS

is restrained in custody for alleged violation of international law or other reason claimed by the government or group under which the person is being held. **e. interned** — The casualty is definitely known to have been taken into custody of a nonbelligerent foreign power as the result of and for reasons arising out of any armed conflict in which the Armed Forces of the United States are engaged. **f. missing** — The casualty is not present at his or her duty location due to apparent involuntary reasons and whose location is unknown. **g. missing in action (MIA)** — The casualty is a hostile casualty, other than the victim of a terrorist activity, who is not present at his or her duty location due to apparent involuntary reasons and whose location is unknown. (See also casualty.) See FMs 8-10, 8-10-1, 8-10-4, 8-10-14, and 8-10-24.

missing in action (MIA) — *See* missing.

mission (JP 1-02) — **1.** The task, together with the purpose, that clearly indicates the action to be taken and the reason therefor. **2.** In common usage, especially when applied to lower military units, a duty assigned to an individual or unit; a task. **3.** The dispatching of one or more aircraft to accomplish one particular task. (Army) — The commander's expression of what the unit must accomplish and for what purpose. (See also commander's intent.) See FMs 100-5, 100-90, and 101-5.

mission, enemy, terrain, troops, and time available (METT-T) — The phrase or acronym used to describe the factors that must be considered during the planning or execution of a tactical operation. See FM 101-5. (USMC) — mission, enemy, terrain and weather, troops and support available, and time available. Example considerations are:

mission — The who, what, when, where, and why that must be accomplished.

enemy — Current information concerning the enemy's strength, location, disposition, activity, equipment, and capability and a determination as to the enemy's probable course of action.

terrain (includes weather) — Analysis of vegetation, soil type, hydrology, climatic conditions, and light data to determine the impact the environment can have on current and future operations for both enemy and friendly operations.

troops (and support available) — The quantity, level of training, and psychological state of friendly forces, to include the availability of weapon systems and critical equipment.

time available — The time available to plan, prepare, and execute operations for both enemy and friendly forces.

mission essential task — A collective task in which an organization must be proficient to accomplish an appropriate portion of its wartime mission(s). See FMs 25-100 and 25-101.

mission essential task list (METL) — A compilation of collective mission essential tasks which must be successfully performed if an organization is to accomplish its wartime mission(s). See FMs 25-100 and 25-101.

mission-oriented protective posture (MOPP) — A flexible system for protection against a chemical or biological attack devised to maximize the unit's ability to accomplish its mission in a toxic environment. This posture permits maximum protection from chemical or biological attack without unacceptable reduction in efficiency. The seven levels of MOPP are shown in the table on the following page.

MOPP Equipment	MOPP LEVELS						
	MOPP READY	MASK ONLY	MOPP ZERO	MOPP 1	MOPP 2	MOPP 3	MOPP 4
Mask	Carried	Worn	Carried	Carried	Carried	Worn ¹	Worn ¹
Overgarment	Ready ³	NOTE	Available ⁴	Worn ¹	Worn ¹	Worn ¹	Worn ¹
Vinyl Overboot	Ready ³	NOTE	Available ⁴	Available ⁴	Worn	Worn	Worn
Gloves	Ready ³	NOTE	Available ⁴	Available ⁴	Available ⁴	Available ⁴	Worn
Helmet Protective Cover	Ready ³	NOTE	Available ⁴	Available ⁴	Worn	Worn	Worn
Chemical Protective Undergarment (CPU)	Ready ³	NOTE	Available ⁴	Worn ¹	Worn ¹	Worn ¹	Worn ¹

¹ In hot weather, coat or hood can be left open for ventilation.
² The CPU is worn under the BDU (primarily applies to SOF) or CVC coveralls.
³ Must be available to the soldier within two hours. Second set available in six hours.
⁴ Must be within arm's reach of soldier.
 NOTE: Items can be ready or available at the commander's discretion.

mission statement — A short paragraph or sentence describing the task and purpose that clearly indicate the action to be taken and the reason therefore. It usually contains the elements of who, what, when, and where, and the reason therefore, but seldom specifies how. (See also commander's intent, operation order (OPORD), and operation plan (OPLAN).) See FMs 100-5, 100-90, and 101-5.

mission type order (JP 1-02) — **1.** Order issued to a lower unit that includes the accomplishment of the total mission assigned to the higher headquarters. **2.** Order to a unit to perform a mission without specifying how it is to be accomplished. (See also commander's intent, operation order (OPORD), and operation plan (OPLAN).) (Army) — Specifies what subordinate commanders are to do without prescribing how they must do it. Mission type orders enable the command to seize and maintain initiative and to set the terms of battle. Mission type orders allow subordinate leaders to exercise independent judgment and exploit hanging situations. See FM 101-5.

mobile defense (JP 1-02) — Defense of an area or position in which maneuver is used with organization of fire and utilization of terrain to seize the initiative from the enemy. (Army) — A defense that orients on the destruction or defeat of the enemy through a decisive attack by the striking force. The minimum force is committed to a fixing force to shape the penetration while the maximum combat power available to the commander is dedicated to the striking force (with a mobility greater than the enemy's) which catches the enemy as he is attempting to overcome that part of the force dedicated to defense. (See also counterattack and defensive operations.) See FMs 1-111, 6-20, 7-20, 7-30, 17-95, 71-100, 71-123, 100-15, 100-40, and 101-5.

mobile training team (MTT) (JP 1-02) — A team consisting of one or more US military or civilian personnel sent on temporary duty, often to a foreign nation, to give instruction. The mission of the team is to train indigenous personnel to operate, maintain, and employ weapons and support systems, or to

OPERATIONAL TERMS AND GRAPHICS

develop a self-training capability in a particular skill. The National Command Authorities may direct a team to train either military or civilian indigenous personnel, depending upon host nation requests.

mobility (JP 1-02, NATO) — A quality or capability of military forces which permits them to move from place to place while retaining the ability to fulfill their primary mission. (Army) — Those activities that enable a force to move personnel and equipment on the battlefield without delays due to terrain or obstacles.

mobility corridors — Areas where a force will be canalized due to terrain constructions. The mobility corridor is relatively free of obstacles and allows military forces to capitalize on the principles of mass and speed. See FMs 21-26, 34-130, and 101-5.

mobility operations — Obstacle reduction by maneuvering and engineer units to reduce or negate the effects of existing or reinforcing obstacles. The objectives are to maintain freedom of movement for maneuver units, weapon systems, and critical supplies. (See also breach, countermobility operations, survivability operations, and terrain reinforcement.) See FM 5-101.

mobility and survivability — A battlefield operating system that preserves the freedom of maneuver of friendly forces (includes breaching enemy obstacles, increasing battlefield circulation, and improving existing routes) and protects them from the effects of enemy weapon systems and from natural occurrences (includes hardening of facilities and fortification of battle positions). See FMs 5-101, 5-102, 71-100, 100-5, and 100-15. **3-27 to 3-33**

mobilization (JP 1-02) — **1.** The act of assembling and organizing national resources to support national objectives in time of war or other emergencies. **2.** The process by which the Armed Forces or part of them are brought to a state of readiness for war or other national emergency. This includes activating all or part of the Reserve components as well as assembling and organizing personnel, supplies, and materiel. Mobilization of the Armed Forces includes, but is not limited to, the following categories: **a. selective mobilization** — Expansion of the active Armed Forces resulting from action by Congress and/or the President to mobilize Reserve component units, individual ready reservists, and the resources needed for their support to meet the requirements of a domestic emergency that is not the result of an enemy attack. **b. partial mobilization** — Expansion of the active Armed Forces resulting from action by Congress (up to full mobilization) or by the President (not more than 1,000,000 for not more than 24 consecutive months) to mobilize Ready Reserve component units, individual reservists, and the resources needed for their support to meet the requirements of a war or other national emergency involving an external threat to the national security. **c. full mobilization** — Expansion of the active Armed Forces resulting from action by Congress and the President to mobilize all Reserve component units in the existing approved force structure, all individual reservists, retired military personnel, and the resources needed for their support to meet the requirements of a war or other national emergency involving an external threat to the national security. Reserve personnel can be placed on active duty for the duration of the emergency plus six months. **d. total mobilization** — Expansion of the active Armed Forces resulting from action by Congress and the President to organize and/or generate additional units or personnel, beyond the existing force structure, and the resources needed for their support, to meet the total requirements of a war or other national emergency involving an external threat to the national security.

moderate risk (nuclear) (JP 1-02) — A degree of risk where anticipated effects are tolerable, or at worst a minor nuisance. (Army) — Moderate risk should not be exceeded if troops are expected to operate at full efficiency after a friendly burst. Risk is expressed in terms of risk to unwarned, exposed personnel; warned, exposed personnel; warned, protected personnel. (See also degree of risk; emergency risk)

(nuclear); negligible risk (nuclear); troop safety (nuclear).) See FMs 100-30 and JPs 3-12.1, 3-12.2, and 3-12.3.

mode of transport (JP 1-02) — The various modes used for a movement. For each mode, there are several means of transport. They include inland surface transportation (rail, road, and inland waterway); sea transport (coastal and ocean); air transportation; and pipelines. See FM 55-30.

modularity — a concept to provide force elements that are interchangeable, expandable, and tailorable to meet changing missions and needs. Modular units will combine the assets required to provide a support function or group of related functions. A module can be sent to support a deploying force without adversely affecting the ability of the parent unit to function at a reduced level.

mortuary affairs — Broadly based military program to provide care and disposition of deceased personnel. It consists of three subprograms: the current death program, the graves registration program, and the concurrent return program. (See also graves registration.) See FMs 10-63 and 100-10. **4-26**

mosaic (JP 1-02, NATO) — An assembly of overlapping photographs that have been matched to form a continuous photographic representation of a portion of the surface of the Earth. See FMs 21-26 and 34-1.

mounted forces — Forces that project, deliver, and sustain combat power in a rapid, highly lethal, and survivable manner with sufficient combat power to occupy and control terrain to dominate adversaries within hostile environments during war and stability and support operations. They are capable of reconnaissance, either mounted or dismounted, and security operations, and have the ability to close with and defeat an enemy. See FMs 17-95 and 71-100.

mounted operations (Army) — The application of combat power from a mobile weapon systems platform which relies upon mechanization and technology to maximize speed, firepower, protection, and survivability in the execution of operations. See FMs 17-95 and 71-100.

mounting (JP 1-02, NATO) — **1.** All preparations made in areas designated for the purpose, in anticipation of an operation. It includes the assembly in the mounting area, preparation and maintenance within the mounting area, movement to loading points, and subsequent embarkation into ships, craft, or aircraft if applicable. **2.** A carriage or stand upon which a weapon is placed.

mounting phase — The period after receipt of the warning order or planning directive until aircraft take off or ships depart on the mission. During this period, joint tactical and support planning is accomplished; troops, equipment, and supplies are assembled and readied; and briefings are conducted. Marshalling takes place during the last part of the mounting phase and includes movement of participating personnel, supplies, and all equipment to departure areas, and their loading into aircraft or ships. (See also air movement, assault phase, and subsequent operations phase.)

movement bid — A request for clearance to move on main supply routes to other controlled routes for which a clearance is required prior to initiating the movement.

movement to contact (Army) — (NATO: advance to contact) A form of the offense designed to develop the situation and to establish or regain contact. (See also meeting engagement, offensive operations, and reconnaissance in force.) See FMs 7-10, 7-20, 7-30, 71-100, 71-123, and 100-15.

movement control (JP 1-02) — The planning, routing, scheduling, and control of personnel and cargo movements over lines of communications; also an organization responsible for these functions. (Army) —

OPERATIONAL TERMS AND GRAPHICS

Organizations responsible for these functions are movement control teams, movement control centers, and movement control activities. See FM 55-10.

movement credit (JP 1-02, NATO) — The allocation granted to one or more vehicles in order to move over a controlled route in a fixed time according to movement instructions.

movement formation — **1.** An ordered arrangement of troops and/or vehicles for a specific purpose. **2.** An ordered arrangement of two or more units, aircraft, or ships proceeding together under a commander. Types of formations include: box, column, diamond, line, vee, wedge, echelon (right or left). (See also box formation, column formation, diamond formation, line formation, vee formation, wedge formation, echelon formation, and movement techniques.) See FMs 1-111, 1-112, 7-7, 7-8, 7-10, 7-20, 7-30, 17-95, 71-100, and 71-123.

movement order (JP 1-02) — An order issued by a commander covering the details for a move of the command. See FM 101-5.

movement requirement (JP 1-02) — A stated movement mode and time-phased need for the transport of units, personnel, and/or materiel from a specified origin to a specified destination.

movement schedule (JP 1-02) — A schedule developed to monitor or track a separate entity whether it is a force requirement, cargo or personnel increment, or lift asset. The schedule reflects the assignment of specific lift resources (such as an aircraft or ship) that will be used to move the personnel and cargo included in a specific movement increment. Arrival and departure times at ports of embarkation, etc., are detailed to show a flow and workload at each location. Movement schedules are detailed enough to support plan implementation. See FMs 55-10, 71-123, and 101-5.

movement table (JP 1-02, NATO) — A table giving detailed instructions or data for a move. When necessary it will be qualified by the words road, rail, sea, air, etc. to signify the type of movement. It is normally issued as an annex to a movement order or instruction. (See also movement order.) See FMs 55-10, 71-123, and 101-5.

movement technique — Manner of traversing terrain used by a unit (such as traveling, traveling overwatch, and bounding overwatch) which is determined by the likelihood of enemy contact.

multiagency — Pertaining to activities or operations conducted by or through coordination with nongovernmental, international, or foreign government agencies.

multinational — Pertaining to activities or operations conducted by or through coordination with the military forces of two or more nations.

multinational operations (JP 1-02) — A collective term to describe military actions conducted by forces of two or more nations, typically organized within the structure of a coalition or alliance. See JP 0-2.

multinational warfare — *See* combined warfare.

multiparty — Pertaining to activities or operations conducted by or through coordination with two or more groups, at least one of which is not a nationally or an internationally recognized group or representative.

multi-spectral imagery (JP 1-02, NATO) — The image of an object obtained simultaneously in a number of discrete spectral bands. (Army) — For example; thermal or infrared, visual, or light intensification. See FMs 34-2 and 34-3.

multispectral smoke — A specifically formulated type smoke which does not allow an observer to see through it. It is effective at blocking all observation from the unaided eye, thermal imagery, radar telemetry, and so forth.

mutual support (JP 1-02, NATO) — That support which units render each other against an enemy because of their assigned tasks, their position relative to each other and to the enemy, and their inherent capabilities. (Army) — **1.** It normally is associated with support rendered through fire and movement. **2.** A condition which exists when positions are able to support each other by direct fire, thus preventing the enemy from attacking one position without being subjected to direct fire from one or more adjacent positions. (See also support.) See FMs 1-111, 6-20, 7-20, 7-30, 17-95, 71-100, 71-123, 100-15, 100-40, and 101-5.

N

named area of interest (NAI) — A point or area along a particular avenue of approach through which enemy activity is expected to occur. Activity or lack of activity within an NAI will help to confirm or deny a particular enemy course of action. (See also event template.) See FM 34-130. **3-20**

nap-of-the-earth flight — *See* terrain flight.

national command (NATO) — A command that is organized by, and functions under the authority of, a specific nation. It may or may not be placed under a NATO commander.

national intelligence support team (NIST) (JP 1-02) — A nationally sourced team composed of intelligence and communications experts from either Defense Intelligence Agency, Central Intelligence Agency, National Security Agency, or any combination of these agencies.

nation assistance (JP 1-02) — Civil and/or military assistance rendered to a nation by foreign forces within that nation's territory during peacetime, crises or emergencies, or war based on agreements mutually concluded between nations. Nation assistance programs include, but are not limited to, security assistance, foreign internal defense, other US Code Title 10 (DOD) programs, and activities performed on a reimbursable basis by Federal agencies or international organizations. See FMs 8-42 and 100-20.

natural disaster — *See* domestic emergencies.

natural environment (Army) — The human ecosystem, including both the physical and biological systems that provide resources (clean air, clean water, healthy surroundings, sufficient food) necessary to sustain productive human life. Included in the natural environment are man-made structures, such as water and wastewater treatment facilities and natural cultural resources.

natural resource — The natural wealth of a country or area, including land, wildlife, plant life, air, water, mineral deposits, and so forth.

naval gunfire support (NGFS) (JP 1-02) — Fire provided by Navy surface gun systems in support of a unit or units tasked with achieving the commander's objectives. A subset of naval surface fire support. (See also amphibious operation and air/naval gunfire liaison company (ANGLICO).) See FMs 6-series and 71-100-3.

4-15

OPERATIONAL TERMS AND GRAPHICS

NBC defense (JP 1-02) — Nuclear defense, biological defense, and chemical defense, collectively. The term may not be used in the context of US offensive operations. **3-34 to 3-36**

NBC monitoring — A protective measure performed by units to ensure advanced early warning for contamination hazards from the use of weapons of mass destruction. It primarily includes sensor warning of the presence of primarily nuclear or chemical materials. Monitoring may be either periodic or continuous. See FM 3-19.

NBC reconnaissance — A mission undertaken to obtain information (of military significance) about unknown NBC contamination pertaining to routes, areas, and zones. This information confirms or denies the presence or absence of NBC attacks or NBC hazards through the use of detection and identification equipment or visual observation, or by the collection of samples in any specified location or region by using NBC detection, identification, and sampling equipment. See FM 3-19.

NBC surveillance — The systematic observation of aerospace, surface or subsurface areas, places, persons, or things by visual, electronic, mechanical, or other means for NBC attacks or hazards. See FM 3-19.

NBC survey — The collection of detailed information (of military significance) pertaining to specific contaminated areas to determine the type of contaminant and degree (extent or intensity) of the NBC hazard. This survey typically determines the outer boundaries of the hazard area. (See also reconnaissance (recon, recce).) See FM 3-19.

near real time (JP 1-02, NATO) — Pertaining to the timeliness of data or information which has been delayed by the time required for electronic communication and automatic data processing. This implies that there are no significant delays. (See also real time.)

negligible risk (nuclear) (JP 1-02) — A degree of risk where personnel are reasonably safe, with the exceptions of dazzle or temporary loss of night vision. (Army) — Expressed in terms of risk to unwarned, exposed personnel; warned, exposed personnel; and warned, protected personnel. (See also degree of risk (nuclear), emergency risk (nuclear), and moderate risk (nuclear).) See FM 100-30, JPs 3-12.2, and 3-12.3.

negligible risk levels — Level of contamination that will cause mild incapacitation among no more than 5 percent of unprotected soldiers who operate for 12 continuous hours within 1 meter of contaminated surfaces. See FM 3-5.

nerve agent (JP 1-02, NATO) — A potentially lethal chemical agent which interferes with the transmission of nerve impulses. See FMs 3-9 and 8-10-7.

nested concept (Army) — The means to achieve unity of purpose whereby each succeeding echelon's concept is nested in the other.

net control station (NCS) (JP 1-02) — A communications station designated to control traffic and enforce circuit discipline within a given net.

neutral — **1.** When the temperature of the ground is approximately the same as the temperature of the lower air up to 4 meters above it. This condition has light to moderate winds and slight turbulence, and is considered average for the release of chemical agents. (See also inversion and lapse.) See FM 3-6. **2.** An individual, a group of individuals, an organization, or a nation which is not hostile or in any way supportive of only one belligerent force in a hostile environment.

neutrality (JP 1-02) — In international law, the attitude of impartiality, during periods of war, adopted by third states toward belligerent and recognized by the belligerent, which creates rights and duties between the impartial states and the belligerent. In a United Nations enforcement action, the rules of neutrality apply to impartial members of the United Nations except so far as they are excluded by the obligation of such members under the United Nations Charter.

neutralization(JP 1-02, NATO) — In mine warfare, a mine is said to be neutralized when it has been rendered, by external means, incapable of firing on passage of a target, although it may remain dangerous to handle. See FMs 5-34 and 5-101.

neutralization fire (JP 1-02) — Fire which is delivered to render the target ineffective or unusable. (NATO) — Fire that is delivered to hamper and interrupt movement and/or the firing of weapons. (Army) — Fires which are intended to render a target out of the battle temporarily by causing a minimum of 10 percent casualties. See FM 6-20-10.

neutralize (JP 1-02) — As pertains to military operations, to render ineffective or unusable. (Army) —
1. To render enemy personnel or material incapable of interfering with a particular operation. **2.** To render safe mines, bombs, missiles, and boobytraps. **3.** To make harmless anything contaminated with a chemical agent. **C-10**

N-hour/N-hour sequence — The unspecified time that commences unit notification and outload for rapid, no-notice deployment on a contingency operation. N-hour initiates a predetermined sequence of events that enables the unit to recall personnel, complete crisis action planning, conduct final personnel readiness procedures, draw and prepare equipment for deployment, and move to a point of embarkation for immediate deployment.

no-fire area (NFA) — An area in which no fires or effects of fires are allowed. Two exceptions are (1) when establishing headquarters approves fires temporarily within the NFA on a mission basis, and (2) when the enemy force within the NFA engages a friendly force, the commander may engage the enemy to defend his force. **3-21**

no-fire line (NFL) (JP 1-02, NATO) — A line short of which artillery or ships do not fire except on request or approval of the supported commander, but beyond which they may fire at any time without danger to friendly troops. **3-22**

nonaligned state (JP 1-02) — A state which pursues a policy of nonalignment.

nonalignment (JP 1-02) — The political attitude of a state which does not associate or identify itself with the political ideology or objective espoused by other states, groups of states, or international causes, or with the foreign policies stemming therefrom. It does not preclude involvement, but expresses the attitude of no precommitment to a particular state (or block) or policy before a situation arises.

nonbattle injury — A person who becomes a casualty due to circumstances not directly attributable to hostile action or terrorist activity. Casualties due to the elements, self-inflicted wounds, and combat fatigue are nonhostile casualties.

noncombatant — **1.** An individual, in an area of combat operations, who is not armed and is not participating in any activity in support of any of the factions or forces involved in combat. **2.** An individual, such as a chaplain or medical personnel, whose duties do not involve combat.

OPERATIONAL TERMS AND GRAPHICS

noncombatant evacuation operations (NEO) (JP 1-02) — Operations conducted to relocate threatened noncombatants from locations in a foreign country. These operations normally involve US citizens whose lives are in danger, and may also include selected foreign nationals. See FMs 90-29, 100-5, and JP 3-07.

nongovernmental organization (NGO) (JP 1-02) — Transnational organizations of private citizens that maintain a consultative status with the Economic and Social Council of the United Nations. NGOs may be professional associations, foundations, multinational businesses, or simply groups with a common interest in humanitarian assistance activities (development and relief). NGO is a term normally used by non-US organizations. (Army) — NGO is the equivalent of the term private voluntary organization (PVO) used in the United States. (See also military operations other than war (MOOTW) and support and stability operations (SASO).) See FM 100-20 and JP 3-07. **D-8**

nonhostile casualty (JP 1-02) — A person who becomes a casualty due to circumstances not directly attributable to hostile action or terrorist activity. Casualties due to the elements, self-inflicted wounds, and combat fatigue are nonhostile casualties. See FMs 8-10, 8-10-1, 8-10-4, 8-10-14, and 8-10-24.

nonlethal fires — Any fires that do not directly seek destruction of the intended target and are designed to impair, disrupt, or delay the performance of enemy operational forces, functions, and facilities. Psychological operations, special operations forces, electronic warfare (jamming), and other command and control countermeasures are all nonlethal fire options. See FMs 6-20 series, 34-1, and 100-25.

nonpersistent agent — A chemical agent that, when released, dissipates or loses its ability to cause casualties from within minutes to several hours. See FM 3-9.

nonproliferation— Efforts focusing on preventing the spread of missiles and weapons of mass destruction via such mechanisms as arms, technology, and export controls. See FM 100-30.

nonunit-related cargo — All equipment and supplies requiring transportation to an area of operations other than that identified as the equipment or accompanying supplies of a specific unit. See FM 701-58.

North Atlantic Treaty Organization (NATO) — An organization of nations in North America and Western Europe that have common political goals.

notice to airmen (NOTAM) (JP 1-02, NATO) — A notice containing information concerning the establishment, condition, or change in any aeronautical facility, service, procedures, or hazard, the timely knowledge of which is essential to personnel concerned with flight operations. See FMs 1-103 and 1-111.

not mission capable, maintenance (NMCMM) (JP 1-02) — Material condition indicating that systems and equipment are not capable of performing any of their assigned missions because of maintenance requirements. See FM 63-2.

not mission capable, supply (NMCS) (JP 1-02) — Material condition indicating that systems and equipment are not capable of performing any of their assigned missions because of maintenance work stoppage due to a supply shortage. See FM 63-2.

nuclear, biological, and chemical warning and reporting system (NBCWRS) — The primary means of warning units of an actual or a predicted NBC hazard. The report formats are standardized by ATP 45/STANAG 2103 Ch 4 (Jan 89) and the US Message Text Format (USMTF). See FM 3-3. It consists of six standardized reports:

- NBC 1** — Initial report.
NBC 2 — Evaluated data.
NBC 3 — Predicted contamination/hazard areas.
NBC 4 — Monitoring/survey results.
NBC 5 — Actual contamination areas.
NBC 6 — Detailed information.

nuclear collateral damage (JP 1-02, NATO) — Undesired damage or casualties produced by the effects from friendly nuclear weapons. See FM 100-30, JPs 3-12.2, and 3-12.3.

nuclear damage assessment (JP 1-02, NATO) — The determination of the damage effect to the population, forces, and resources resulting from actual nuclear attack. It is performed during and after an attack. The operational significance of the damage is not evaluated in this assessment. See FM 100-30, JPs 3-12.2, and 3-12.3.

nuclear strike warning (JP 1-02, NATO) — A warning of impending friendly or suspected enemy nuclear attack. See FM 100-30, JPs 3-12.2, and 3-12.3.

nuclear weapon option — A discrete grouping of a specific number of nuclear weapons by specific yield planned for employment in a specific area for a designated time frame. See FM 100-30, JPs 3-12.2, and 3-12.3.

nuclear yields (JP 1-02) — The energy released in the detonation of a nuclear weapon measured in terms of the kilotons or megatons of trinitrotoluene (TNT) required to produce the same energy release. See FM 100-30, JPs 3-12.2, and 3-12.3. Yields are categorized as:

- Very low** — less than 1 kiloton.
Low — 1 kiloton to 10 kilotons.
Medium — over 10 kilotons to 50 kilotons.
High — over 50 kilotons to 500 kilotons.
Very high — over 500 kilotons.

O

objective (JP 1-02, NATO) — The physical object of the action taken, e.g., a definite tactical feature, the seizure and/or holding of which is essential to the commander's plan. (Army) — **1.** The physical object of the action taken (for example, a definite terrain feature, the seizure or holding of which is essential to the commander's plan, or, the destruction of an enemy force without regard to terrain features). **2.** The clearly defined, decisive, and attainable aims which every military operation should be directed towards. **3.** The most important decisive points. (See also decisive point.) See FMs 1-111, 6-20, 7-20, 7-30, 17-95, 71-100, 71-123, 100-15, and 101-5. **3-17**

objective area (JP 1-02, NATO) — **1.** A defined geographical area within which is located an objective to be captured or reached by the military forces. This area is defined by competent authority for purposes of command and control. (DOD) **2.** The city or other geographical location where a civil disturbance is occurring or is anticipated, and where Federal Armed Forces are, or may be, employed. See FMs 1-111, 6-20, 7-20, 7-30, 17-95, 71-100, 71-123, 100-15, 100-20, and 101-5.

obscurant — A gas, liquid, solid particle, or combination of these, either man-made (such as smoke) or natural (such as dust), suspended in the atmosphere, that may attenuate or block any portion of the

OPERATIONAL TERMS AND GRAPHICS

electromagnetic spectrum. This can affect such things as visual observation, laser rangefinders or designators, radars, and thermal sites.

obscuration — The effects of weather, battlefield dust, and debris, or the use of smoke munitions to hamper observation and target-acquisition capability or to conceal activities or movement.

obscuring smoke — Smoke placed between enemy forces and friendly forces or directly on enemy positions to confuse and disorient enemy direct-fire gunners and artillery forward observers. See FM 3-100. **3-24**

observation post (OP) (JP 1-02, NATO) — A position from which military observations are made, or fire directed and adjusted, and which possesses appropriate communications; it may be airborne. See FMs 1-111, 6-20, 7-20, 7-30, 17-95, 71-100, 71-123, 100-15, 100-40, and 101-5. **4-17**

observed fire (JP 1-02, NATO) — Fire for which the point of impact or burst can be seen by an observer. The fire can be controlled and adjusted on the basis of observation. See FMs 6-series and 7-90.

observer-target line (JP 1-02, NATO) — An imaginary straight line from the observer/spotter to the target. See FMs 6-series and 7-90.

obstacle (JP 1-02) — Any obstruction designed or employed to disrupt, fix, turn, or block the movement of an opposing force, and to impose additional losses in personnel, time, and equipment on the opposing force. Obstacles can exist naturally or can be man-made, or can be a combination of both. (Army) — Obstacles can be used to protect friendly forces from close assault. (See also reinforcing obstacles.) See FM 90-7. **3-29**

obstacle belt (JP 1-02) — A brigade-level command and control measure, normally given graphically, to show where within an obstacle zone the ground tactical commander plans to limit friendly obstacle employment and focus the defense. It assigns an intent to the obstacle plan and provides the necessary guidance on the overall effect of obstacles within a belt. (Army) — It also supports the intent of the higher headquarters obstacle zone. (See also obstacle.) See FM 90-7. **3-29**

obstacle group — Normally, a task force-level obstacle control measure that specifies the location of one or more obstacles grouped to provide a specific obstacle effect. Obstacle groups are shown using the obstacle effect graphics. See FM 90-7.

obstacle line — A conceptual control measure used at battalion or brigade level to show placement intent without specifying a particular type of linear obstacle. **3-29**

obstacle plan — That part of an operation plan (OPLAN) (or order) which is concerned with the use of obstacles to enhance friendly fires or to affect the movement of an enemy. Obstacle plans are used at corps level and below. (See also countermobility operations and obstacle.) See FM 90-7.

obstacle restricted areas (JP 1-02) — A command and control measure used to limit the type or number of obstacles within an area. (Army) — A commander may use restricted areas to prevent subordinates from emplacing obstacles in certain areas. The restricted area is labeled "NO OBSTACLES." (See also obstacle.) See FM 90-7. **3-31**

obstacle zone (JP 1-02) — A division-level command and control measure, normally done graphically, to designate specific land areas where lower echelons are allowed to employ tactical obstacles. (See also countermobility operations and obstacle.) See FM 90-7. **3-29**

occupy — **1.** A tactical task in which a force moves onto an objective, key terrain, or other man-made or natural terrain area without opposition, and controls that entire area. **2.** To remain in an area and retain control of that area. **C-10**

offensive — A principle of war by which a military force achieves decisive results by acting with initiative, employing fire and movement, and sustaining freedom of maneuver and action while causing an enemy to be reactive.

offensive counterair (OCA) — Combat operations that take the initiative to destroy the enemy's ability to operate in the aerospace environment by attacking systems (or their support systems) designed to operate in the atmosphere (for example: a directed-energy system operating in space used to destroy or degrade enemy airfields.).

offensive counterspace (OCS) — Combat operations conducted against enemy systems (or their support systems) designed to operate in space (for example: a directed-energy weapon operating from an aircraft or ground location that is used to destroy enemy satellites.).

offensive operations — Combat operations designed primarily to destroy the enemy. Offensive operations may be undertaken to secure key or decisive terrain, to deprive the enemy of resources or decisive terrain, to deceive or divert the enemy, to develop intelligence, and to hold the enemy in position. Forms of offensive operations include movement to contact, attack, exploitation, and pursuit. The offensive is undertaken to seize, retain, and exploit the initiative. (See also attack, movement to contact, and reconnaissance in force.) See FMs 1-111, 6-20, 7-20, 7-30, 17-95, 71-100, 71-123, 100-5, 100-15, and 101-5.

on-call (JP 1-02) — **1.** A term used to signify that a prearranged concentration, air strike, or final protective fire may be called for. **2.** Preplanned, identified force or materiel requirements without designated time-phase and destination information. Such requirements will be called forward upon order of competent authority. (See also call for fire.) See FMs 6-series, 7-90.

on-call resupply (JP 1-02) — A resupply mission planned before insertion of a special operations team into the operations area but not executed until requested by the operating team.

on-call target (JP 1-02, NATO) — In artillery and naval gunfire support, a planned target other than a scheduled target on which fire is delivered when requested. (See also scheduled target.) See FMs 6-series and 7-90.

on-order mission — A mission to be executed at an unspecified time in the future. A unit with an on-order mission is a committed force. The commander envisions task execution in the concept of operations; however, he may not know the exact time or place of execution. Subordinate commanders develop plans or orders and allocate resources, task-organize, and position forces for execution. (See also be-prepared mission.) See FM 101-5.

one day's supply (JP 1-02, NATO) — A unit or quantity of supplies adopted as a standard of measurement, used in estimating the average daily expenditure under stated conditions. It may also be expressed in terms of a factor, e.g., rounds of ammunition per weapon per day.

operating level of supply (JP 1-02) — The quantities of material required to sustain operations in the interval between requisitions or the arrival of successive shipments. These quantities should be based on the established replenishment period (monthly, quarterly, etc).

OPERATIONAL TERMS AND GRAPHICS

operation (JP 1-02, NATO) — A military action or the carrying out of a strategic, tactical, service, training, or administrative military mission; the process of carrying on combat, including movement, supply, attack, defense, and maneuvers needed to gain the objectives of any battle or campaign. See FMs 1-111, 6-20, 7-20, 7-30, 17-95, 71-100, 71-123, 100-5, 100-15, and 101-5.

operational art (JP 1-02) — The employment of military forces to attain strategic and/or operational objectives through the design, organization, integration, and conduct of strategies, campaigns, major operations, and battles. Operational art translates the joint force commander's strategy into operational design, and, ultimately, tactical action, by integrating the key activities at all levels of war. See FMs 100-5 and 100-15.

operational command (OPCOM) (NATO only) — **1.** The term is synonymous with operational control and is uniquely applied to the operational control exercised by the commanders of combatant, unified, and specified commands over assigned forces. **2.** The authority granted to a commander to assign missions or tasks to subordinate commanders, to deploy units, to reassign forces, and to retain or delegate operational or tactical control as may be deemed necessary. It does not include responsibility for administration or logistics. OPCOM may also be used to denote the forces assigned to a commander. (See also operational control (OPCON).)

operational control (OPCON) (JP 1-02) — Transferable command authority that may be exercised by commanders at any echelon at or below the level of combatant command. Operational control is inherent in combatant command (command authority). Operational control may be delegated and is the authority to perform those functions of command over subordinate forces involving organizing and employing commands and forces, assigning tasks, designating objectives, and giving authoritative direction necessary to accomplish the mission. Operational control includes authoritative direction over all aspects of military operations and joint training necessary to accomplish missions assigned to the command. Operational control should be exercised through the commanders of subordinate organizations. Normally this authority is exercised through subordinate joint force commanders and Service and/or functional component commanders. Operational control normally provides full authority to organize commands and forces and to employ those forces as the commander in operational control considers necessary to accomplish assigned missions. Operational control does not, in and of itself, include authoritative direction for logistics or matters of administration, discipline, internal organization, or unit training. (See also assign, attack, detachment, and operational command (OPCOM).) See JP 0-2.

operational decontamination (JP 1-02, NATO) — Decontamination carried out by an individual and/or a unit, restricted to specific parts of operationally essential equipment, materiel and/or working areas, in order to minimize contact and transfer hazards and to sustain operations. This may include decontamination of the individual beyond the scope of immediate decontamination, as well as decontamination of mission-essential spares and limited terrain decontamination. See FM 3-5.

operational decontamination operations — A decontamination operation that consists of two techniques, the mission-oriented protective posture (MOPP) gear exchange and the vehicle washdown. See FM 3-5.

operational environment (JP 1-02) — A composite of the conditions, circumstances, and influences which affect the employment of military forces and bear on the decisions of the unit commander. Some examples are: **a. permissive environment** — operational environment in which host country military and law enforcement agencies have control and the intent and capability to assist operations that a unit intends to conduct. **b. uncertain environment** — operational environment in which host government forces, whether opposed to or receptive to operations that a unit intends to conduct, do not have totally effective control of the territory and population in the intended area of operations. **c. hostile environment** — operational environment in which hostile forces have control and the intent and capability to effectively oppose or react to the operations a unit intends to conduct.

operational intelligence (JP 1-02) — Intelligence that is required for planning and conducting campaigns and major operations to accomplish strategic objectives within theaters or areas of operations. (See also intelligence, strategic intelligence, and tactical intelligence.) See FM 34-1.

operational level of war (JP 1-02) — The level of war at which campaigns and major operations are planned, conducted, and sustained to accomplish strategic objectives within theaters or areas of operations. Activities at this level link tactics and strategy by establishing operational objectives needed to accomplish the strategic objectives, sequencing events to achieve the operational objectives, initiating actions, and applying resources to bring about and sustain these events. These activities imply a broader dimension of time or space than do tactics; they ensure the logistic and administrative support of tactical forces, and provide the means by which tactical successes are exploited to achieve strategic objectives. See FMs 100-5 and 100-15.

operationally ready (JP 1-02) — **1.** As applied to a unit, ship, or weapon system — Capable of performing the missions or functions for which organized or designed. Incorporates both equipment readiness and personnel readiness. **2.** As applied to personnel — Available and qualified to perform assigned missions or functions. See FM 63-2.

operational operating systems — The major functions performed by joint and combined operational forces for successfully executing campaigns and major operations in a theater or area of operations. The operating systems are operational movement and maneuver, operational fires, operational protection, operational command and control, operational intelligence, and operational support. See FM 100-15.

operational readiness float — A quantity of selected class II and VII items authorized for use by direct support maintenance units in exchange with supported units if a like item cannot be repaired in a timely manner. See FM 63-2-1.

operational reserve (JP 1-02, NATO) — An emergency reserve of men and/or material established for the support of a specific operation. See FMs 100-5 and 100-15.

operational tempo (OPTEMPO) — **1.** The pace of an operation or operations. The OPTEMPO includes all of the activities the unit is conducting. OPTEMPO can be a single activity or a series of operations. **2.** The mileage allowed to be put on a vehicle or aircraft during a fiscal year based on budgetary guidance. See FMs 1-111, 6-20, 7-20, 7-30, 17-95, 71-100, 71-123, 100-15, and 101-5.

operation annexes (JP 1-02) — Those amplifying instructions which are of such a nature, or are so voluminous or technical, as to make their inclusion in the body of the plan or order undesirable. See FM 101-5.

operation exposure guide (OEG) (JP 1-02) — The maximum amount of nuclear radiation which the commander considers a unit may be permitted to receive while performing a particular mission or missions. (Army) — Within the Army it is known as operational exposure guidance (OEG). (See also radiation status (RS).) See FMs 3-3-1 and 100-30.

operation map (JP 1-02) — A map showing the location and strength of friendly forces involved in an operation. It may indicate predicted movement and location of enemy forces. (See also map.) See FM 101-5.

operation order (OPORD) (JP 1-02, NATO) — A directive issued by a commander to subordinate commanders for the purpose of effecting the coordinated execution of an operation. (Army) — Also called the five paragraph field order, it contains as a minimum a description of the task organization,

OPERATIONAL TERMS AND GRAPHICS

situation, mission, execution, administrative and logistics support, and command and signal for the specified operation. (See also operation plan (OPLAN).) See FM 101-5.

operation overlay — Overlay showing the location, size, and scheme of maneuver and fires of friendly forces involved in an operation. As an exception, it may indicate predicted movements and locations of enemy forces.

operation plan (OPLAN) (JP 1-02) — Any plan, except for the Single Integrated Operation Plan, for the conduct of military operations. Plans are prepared by combatant commanders in response to requirements established by the Chairman of the Joint Chiefs of Staff and by commanders of subordinate commands in response to requirements tasked by the establishing unified commander. Operation plans (OPLANs) are prepared in either a complete format (OPLAN) or as a concept plan (CONPLAN). The CONPLAN can be published with or without a time-phased force and deployment data (TPFDD) file. **a. OPLAN.** An operation plan for the conduct of joint operations that can be used as a basis for development of an operation order (OPORD). An OPLAN identifies the forces and supplies required to execute the CINC's Strategic Concept and a movement schedule of these resources to the theater of operations. The forces and supplies are identified in TPFDD files. OPLANs will include all phases of the tasked operation. The plan is prepared with the appropriate annexes, appendixes, and TPFDD files as described in the Joint Operation Planning and Execution System manuals containing planning policies, procedures, and formats. **b. CONPLAN.** An operation plan in an abbreviated format that would require considerable expansion or alteration to convert it into an OPLAN or OPORD. A CONPLAN contains the CINC's Strategic Concept and those annexes and appendixes deemed necessary by the combatant commander to complete planning. Generally, detailed support requirements are not calculated and TPFDD files are not prepared. (See also operation order (OPORD).) See FM 101-5.

operations security (OPSEC) (JP 1-02) — A process of identifying critical information and subsequently analyzing friendly actions attendant to military operations and other activities to: **a.** Identify those actions that can be observed by adversary intelligence systems. **b.** Determine indicators hostile intelligence systems might obtain that could be interpreted or pieced together to derive critical information in time to be useful to adversaries. **c.** Select and execute measures that eliminate or reduce to an acceptable level the vulnerabilities of friendly actions to adversary exploitation. (Army) — All measures taken to maintain security and achieve tactical surprise. It includes countersurveillance, physical security, signal security, and information security. It also involves the identification and elimination or control of indicators which can be exploited by hostile intelligence organizations. (See also command and control warfare (C²W) .) See FMs 34-40 and 101-5.

operator's spraydown — Process of applying decontaminant onto unit equipment control surfaces to stop contamination from spreading, transferring, or soaking into surfaces. See FM 3-5.

opposed entry — A military operation to enter an area against opposition. (See also air assault, airborne, amphibious operation, and assault echelon.) See FMs 1-111, 7-20, 7-30, 71-100-2, 71-100-3, 90-4, and 90-26.

order (JP 1-02, NATO) — A communication, written, oral, or by signal, that conveys instructions from a superior to a subordinate. (DOD) In a broad sense, the terms “order” and “command” are synonymous. However, an order implies discretion as to the details of execution whereas a command does not. (Army) — Also synonymous with requisition as used in “back order.” (See also fragmentary order (FRAGO), movement order, operation order (OPORD), overlay order, and warning order (WARNO).) See FMs 100-34 and 101-5.

order of battle (JP 1-02, NATO) — The identification, strength, command structure, and disposition of the personnel, units, and equipment of any military force.

orders group — A standing group of key personnel requested to be present when a commander at any level issues his concept of operations and his order. See FM 101-5.

order and shipping time (JP 1-02) — The time elapsing between the initiation of stock replenishment action for a specific activity and the receipt by that activity of the materiel resulting from such action. Order and shipping time is applicable only to materiel within the supply system, and it is composed of the distinct elements, order time, and shipping time.

organic (JP 1-02) — Assigned to and forming an essential part of a military organization. Organic parts of a unit are those listed in its table of organization for the Army, Air Force, and Marine Corps, and are assigned to the administrative organizations of the operating forces for the Navy. (See also assign, attach, and operational control (OPCON).) See FM 101-5.

organization — **1.** Any military unit or larger command comprised of two or more smaller units. In this meaning, a military element of a command is an organization in relation to its components and a unit in relation to higher commands. **2.** The definite structure of a military element prescribed by a component authority such as a table of organization. (See also unit.)

organization of the ground (JP 1-02, NATO) — The development of a defensive position by strengthening the natural defenses of the terrain and by assignment of the occupying troops to specific localities. See also defend.) See FMs 1-111, 6-20, 7-20, 7-30, 17-95, 71-100, 71-123, 100-15, 100-40, and 101-5.

organophosphate — A phosphate-containing organic compound which inhibits cholinesterase enzymes that control the transmission of nerve impulses. G-series and V-series nerve agents are organophosphates. See FM 3-9.

over (JP 1-02, NATO) — In artillery and naval gunfire support, a spotting, or an observation, used by a spotter or an observer, to indicate that a burst(s) occurred beyond the target in relation to the spotting line. (Army) — **1.** A communications proword meaning "I have finished speaking, do/does the other party(ies) have anything to say." **2.** In direct fire, a sensing that a round or burst of rounds went above the intended target and landed beyond the target. See FMs 6-series, 7-90, 7-91, 17-12, and 23-1.

overlay (JP 1-02, NATO) — A printing or drawing on a transparent or semitransparent medium at the same scale as a map, chart, etc., to show details not appearing or requiring special emphasis on the original. (Army) — On digital displays, a set of graphical data which can be placed or removed from another set of graphical data without causing the distortion of or damage to either set of graphical data. See FMs 1-111, 6-20, 7-20, 7-30, 17-95, 71-100, 71-123, 100-15, 100-40, and 101-5.

overlay order — A technique used to issue an order (normally a fragmentary order) that has abbreviated instructions written on the overlay itself. On digital systems, it may have hypertext attached to a digital overlay which allows a subordinate to "click on" a key word or graphic and a text display of specific information will appear in a "window" which can be moved or closed by the user so that the graphic is fully visible. (See also operation order (OPORD), overlay, and fragmentary order (FRAGO).) See FM 101-5.

overt operation (JP 1-02) — An operation conducted openly, without concealment.

overwatch — A tactical technique in which one element is positioned to support by fire the movement of another element by observing known or suspected enemy locations and engaging the enemy if he is visible or tries to fire on the friendly element. The overwatching element must be told if it is to destroy, suppress, or fix the enemy. (See also movement technique and support by fire.)

P

packaged petroleum product (JP 1-02) — A petroleum product (generally a lubricant, oil, grease, or specialty item) normally packaged by a manufacturer and procured, stored, transported, and issued in containers having a fill capacity of 55 United States gallons (or 45 Imperial gallons, or 205 liters) or less.

palletized unit load (JP 1-02, NATO) — Quantity of any item, packaged or unpackaged, which is arranged on a pallet in a specified manner and securely strapped or fastened thereto so that the whole is handled as a unit.

paramilitary forces (JP 1-02) — Forces or groups which are distinct from the regular armed forces of any country, but resembling them in organization, equipment, training, or mission.

partial mobilization — *See* mobilization.

passage of command — The exchange of responsibility for a sector or zone between the commanders of two units. The time when the command is to pass is determined by mutual agreement between the two unit commanders unless directed by higher headquarters. (See also passage of lines, battle handover, and relief in place (RIP).) See FMs 1-111, 6-20, 7-20, 7-30, 17-95, 71-100, 71-123, 100-15, and 101-5.

passage of lines (JP 1-02, NATO) — An operation in which a force moves forward or rearward through another force's combat positions with the intention of moving into or out of contact with the enemy. (Army) — Passing one unit through the positions of another, as when elements of a covering force withdraw through the forward edge of the main battle area, or when an exploiting force moves through the elements of the force that conducted the initial attack. A passage may be designated as a forward or rearward passage of lines. See FMs 1-111, 6-20, 7-20, 7-30, 17-95, 71-100, 71-123, 100-15, 100-40, and 101-5.

passage point (PP) — A specifically designated place where units will pass through one another either in an advance or a withdrawal. It is located where the commander desires subordinate units to physically execute a passage of lines. See FMs 1-111, 6-20, 7-20, 7-30, 17-95, 71-100, 71-123, 100-15, 100-40, and 101-5.

3-26

passive air defense (JP 1-02, NATO) — All measures, other than active air defense, taken to minimize the effectiveness of hostile air action. These measures include deception, dispersion, and the use of protective construction. (See also active air defense and air defense.) See FMs 44-63 and 44-100.

passive defense (Army) — Applies to measures initiated to reduce vulnerability and to minimize damage caused by theater missile (TM) attacks. Passive defense includes TM counterproliferation and deterrence; TM early warning and nuclear, biological, and chemical protection; countersurveillance; deception; camouflage and concealment; hardening; electronic warfare; mobility; dispersal; redundancy; recovery, and reconstitution.

passive defense measures — Measures taken to reduce the possibilities or effects of nuclear, biological, and chemical attack. See FM 3-3.

pass time (JP 1-02, NATO) — In road transport, the time that elapses between the moment when the leading vehicle of a column passes a given point and the moment when the last vehicle passes the same point.

password (JP 1-02, NATO) — A secret word or distinctive sound used to reply to a challenge. (See also challenge.)

pathfinders (JP 1-02) — **1.** Experienced aircraft crews who lead a formation to the drop zone (DZ), release point, or target. **2.** Teams dropped or airdropped at an objective to establish and operate navigational aids for the purpose of guiding aircraft to drop and landing zones. **3.** A radar device used for navigating or homing to an objective when visibility precludes accurate visual navigation. **4.** Teams air delivered into enemy territory for the purpose of determining the best approach and withdrawal lanes, landing zones, and sites for heliborne forces. (See also landing zone control party.) See FMs 90-4 and 90-26.

pathogen(s) — Disease-producing microorganisms such as bacteria, mycoplasma, rickettsia, fungi, or viruses. See FMs 3-9, 8-10-7, and 8-33.

patient (JP 1-02) — A sick, injured, wounded, or other person requiring medical/dental care or treatment. See FMs 8-10, 8-10-1, and 8-10-6.

patient decontamination — The process of decontaminating contaminated patients using nonmedical personnel as patient decontamination teams working under the supervision of medical personnel. The patient decontamination process is performed at a location adjacent to the supporting medical treatment facility. See FMs 8-10-1, 8-10-4, and 8-10-7. (See also patient decontamination team.)

patient decontamination team — A team composed of nonmedical personnel designated by the echelon commander to perform patient decontamination under supervision of medical personnel. See FMs 8-10-1, 8-10-4, and 8-10-7.

patrol (JP 1-02, NATO) — A detachment of ground, sea, or air forces sent out for the purpose of gathering information or carrying out a destructive, harassing, mopping-up, or security mission. See FMs 7-7, 7-8, and 7-10.

patrol base — The point of origin of a patrol where all equipment not required for the patrol is left. All supplies necessary for resupplying the patrol and additional medical supplies and assistance are staged at this location. See FMs 7-7, 7-8, and 7-10.

payload (JP 1-02, NATO) — **1.** The sum of the weight of passengers and cargo that an aircraft can carry. **2.** The warhead, its container, and activating devices in a military missile. **3.** The satellite or research vehicle of a space probe or research missile. **4.** The load (expressed in tons of cargo or equipment, gallons of liquid, or number of passengers) which the vehicle is designed to transport under specified conditions of operation, in addition to its unladen weight. See FM 55-30.

peace building (JP 1-02) — Postconflict actions, predominately diplomatic and economic, that strengthen and rebuild governmental infrastructure and institutions in order to avoid a relapse into conflict. See FM 100-23 and JP 3-07.

peace enforcement (JP 1-02) — Application of military force, or the threat of its use, normally pursuant to international authorization, to compel compliance with resolutions or sanctions designed to maintain or restore peace and order. See FMs 100-20, 100-23, and JP 3-07.

peacekeeping (JP 1-02) — Military operations undertaken with the consent of all major parties to a dispute, designed to monitor and facilitate implementation of an agreement (cease fire, truce, or other such agreement) and support diplomatic efforts to reach a long-term political settlement. See FMs 100-20, 100-23, and JP 3-07.

OPERATIONAL TERMS AND GRAPHICS

peacemaking (JP 1-02) — The process of diplomacy, mediation, negotiation, or other forms of peaceful settlements that arranges an end to a dispute, and resolves issues that led to it. See FMs 100-20, 100-23, and JP 3-07.

peace operations (JP 1-02) — A broad term that encompasses peacekeeping operations and peace enforcement operations conducted in support of diplomatic efforts to establish and maintain peace. See FMs 100-20, 100-23, and JP 3-07.

pecuniary liability (JP 1-02) — A personal, joint, or corporate monetary obligation to make good any lost, damaged, or destroyed property resulting from fault or neglect. It may also result under conditions stipulated in a contract or bond.

penetration (JP 1-02, NATO) — In land operations, a form of offensive which seeks to break through the enemy's defense and disrupt the defensive system. (Army) — A choice of maneuver. (See also choice of maneuver.) See FMs 1-111, 6-20, 7-20, 7-30, 17-95, 71-100, 71-123, 100-15, and 101-5. **C-10**

perimeter defense (JP 1-02) — A defense without an exposed flank, consisting of forces deployed along the perimeter of the defended area. (See also defensive operations and strongpoint (SP).) See FMs 1-111, 6-20, 7-20, 7-30, 17-95, 71-100, 71-123, 100-15, and 101-5.

periodic intelligence summary (PERINTSUM) (JP 1-02) — A report of the intelligence situation in a tactical operation, normally produced at corps level or its equivalent, and higher, usually at intervals of 24 hours, or as directed by the commander. See FMs 34-1, 34-2, 34-3, and 34-8.

periodic monitoring — The periodic check of the unit area for presence of beta or gamma radiation. It is performed when intelligence indicates threat use of nuclear weapons, nuclear warfare has been initiated, the dose rate falls below 1 centigray per hour, or when ordered by the unit commander. See FM 3-100.

permissive environment — See operational environment.

persistency (JP 1-02, NATO) — In biological or chemical warfare, the characteristic of an agent which pertains to the duration of its effectiveness under determined conditions after its dispersal. See FM 3-9.

persistent chemical agent — A liquid or dust-like compound that remains hazardous for hours, days or, in exceptional cases, weeks or more. It can be both a surface contact hazard or an airborne (vapor or particle) hazard. It can be picked up on a surface and might not be removed through decontamination; it can be spread to noncontaminated areas retaining its original lethality.

personal wipedown — Process of removing or neutralizing contamination from the individual's equipment including the protective mask, hood, gloves, weapon, and helmet. It is performed to stop the spread, transfer, and penetration of contamination. See FM 3-5.

petroleum, oils, and lubricants (POL) (JP 1-02, NATO) — A broad term which includes all petroleum and associated products used by the Armed Forces. (Army) — Also known as class III supplies. See FM 100-10. **3-39** **4-28**

phase — A specific part of an operation that is different from those that precede or follow. A change in phase usually involves a change of task. Phasing assists in planning and controlling and may be indicated by time (preparatory fire phase), by distance (intermediate objective or report line), by terrain (crossing of an obstacle), or by occurrence of an event (commitment of a reserve). It is not to be confused with a phase line (PL). It normally is associated in campaign planning with operations of larger units and with

special operations (such as river crossing and airborne operations). Each phase may be defined by a change in task organization or a distinct end state. See FM 101-5.

phase line (PL) (JP 1-02, NATO) — A line used for control and coordination of military operations, usually a terrain feature extending across the zone of action. (Army) — It is usually along a recognizable terrain feature extending across the sector or zone of action. Units normally report crossing PLs, but do not halt unless specifically directed. See FMs 7-10, 7-20, 7-30, 17-1, 17-2, 17-3, 71-100, 100-15, and 101-5.

3-13

3-26

physical security (JP 1-02, NATO) — That part of security concerned with physical measures designed to safeguard personnel; to prevent unauthorized access to equipment, installations, material, and documents; and to safeguard them against espionage, sabotage, damage, and theft. (See also operations security (OPSEC) and communications security (COMSEC).) See FMs 19-1 and 34-1.

pickup zone (PZ) — A geographic area used to pick up troops or equipment by helicopter. **3-13**

pickup zone control officer (PZCO) — The officer designated by the commander with the responsibility for establishing, organizing, setting up, and controlling the pickup zone during air assault PZ operations. See FMs 1-111, 71-100-3, and 90-4.

pickup zone control party — The personnel designated to assist the pickup zone control officer with the establishment, setting up, and controlling of the PZ. See FMs 1-111, 71-100-3, and 90-4.

pilot report (PIREP) — A report rendered by a pilot during a mission containing the specified information. A PIREP could be for reconnaissance, enemy contact, weather, battle damage assessment, or any number of other requirements. See FM 71-100-3.

planned target (JP 1-02, NATO) — In artillery and naval gunfire support, a target on which fire is prearranged. (Army) — A target is planned on an area or a point in which a need is anticipated. A planned target may be scheduled or on call. Firing data for a planned target is normally calculated in advance. Coordination with friendly troops and aircraft is mandatory. (See also scheduled target, on-call target, and priority target.) See FMs 6-series and 7-90.

planning factor (JP 1-02, NATO) — A multiplier used in planning to estimate the amount and type of effort involved in a contemplated operation. Planning factors are often expressed as rates, ratios, or lengths of time. See FMs 101-5, 101-10-1, and 101-10-2.

point defense (JP 1-02) — The defense or protection of special vital elements and installations; e.g., command and control facilities, air bases. See FMs 1-111, 6-20, 7-20, 7-30, 17-95, 44-100, 71-100, 71-123, 100-15, 100-40, and 101-5.

point of departure (PD) — In night or limited visibility attacks, a specific place on the line of departure where a unit will cross. **3-17**

point obstacle — Any obstruction designed or employed to deny ease of movement on a road, lane, or bridge that is normally part of or completes a larger man-made or natural obstacle that has a designed effect on the attacking enemy force. (See also abatis, cratering charge, log crib, log hurdle, log posts, and road block.)

3-29

OPERATIONAL TERMS AND GRAPHICS

point target (JP 1-02) — **1.** A target of such small dimension that it requires the accurate placement of ordnance in order to neutralize or destroy it. **2. nuclear** — A target in which the ratio of radius of damage to target radius is equal to or greater than 5. See FMs 6-series and 7-90.

pop-up point (PUP) — The location at which aircraft quickly gain altitude for target acquisition and engagement. (See also target box.) **3-6**

port (JP 1-02) — A place at which ships may discharge or receive their cargoes. It includes any port accessible to ships on the seacoast, navigable rivers, or inland waterways. The term "ports" should not be used in conjunction with air facilities which are designated as aerial ports, airports, etc.

port of debarkation (POD) (JP 1-02) — The geographic point at which cargo or personnel are discharged. May be a seaport or aerial port of debarkation. For unit requirements, it may or may not coincide with the destination. (See also port of embarkation (POE).) See FM 55-10. **4-29**

port of embarkation (POE) (JP 1-02) — The geographic point in a routing scheme from which cargo or personnel depart. May be a seaport or aerial port from which personnel and equipment flow to port of debarkation. For unit and nonunit requirements, it may or may not coincide with the origin. (See also port of debarkation (POD).) See FM 55-10. **4-29**

position — **1.** A location or area occupied by a military unit. **2.** The location of a weapon, unit, or individual from which fire is delivered upon a target. Positions may be classified as primary, alternate, subsequent, and supplementary positions. (See also alternate position, battle position (BP), primary position, subsequent position, and supplementary position.)

position area for artillery (PAA) — An area assigned to an M109A6 Paladin platoon and other artillery units for terrain management purposes in which the artillery can maneuver. See FM 6-20-60. **3-23**

postconflict activity — Those stability and support operations which are conducted in the period following conflict termination.

power projection — The ability of the nation to apply all or some of the instruments of national power (diplomatic, economic, informational, or military) to respond to crisis, to contribute to deterrence, and to enhance regional stability. See FM 100-5.

precedence (JP 1-02) — **1. communications**--A designation assigned to a message by the originator to indicate to communications personnel the relative order of handling and to the addressee the order in which the message is to be noted. **2. reconnaissance** — A letter designation, assigned by a unit requesting several reconnaissance missions, to indicate the relative order of importance, within an established priority, of the mission requested. (Army) — Examples of communication precedence from most immediate to least are flash, immediate, priority, and routine.

preclusion of damage — A nuclear planning restriction used in conjunction with least separation distance to avoid damage to important structures. If appropriate, it is included in the commander's guidance. (See also least separation distance (LSD) and preclusion of obstacles.) See FM 100-30, JPs 3-12.2, and 3-12.3.

preclusion of obstacles — A nuclear planning restriction used in conjunction with least separation distance which, if appropriate, is included in the commander's guidance. It can include preclusion of fallout and tree blowdown. (See also least separation distance (LSD) and preclusion of damage.) See FM 100-30.

preclusion-oriented method analysis — A method of analyzing nuclear targets used when detailed information about size, composition, disposition, location, and movement is not available. See FM 100-30, JPs 3-12.2, and 3-12.3.

preemptive attack (JP 1-02) — An attack initiated on the basis of incontrovertible evidence that an enemy attack is imminent. See FMs 100-5 and 100-40.

preparation fire (JP 1-02, NATO) — Fire delivered on a target preparatory to an assault. (Army) — Normally the preparation fires include (if available) artillery, mortar, naval gunfire, and close air support to destroy, neutralize, or suppress the enemy's defense and to disrupt communications and disorganize the enemy's defense. (See also artillery preparation.) See FMs 1-111, 6-20, 7-20, 7-30, 17-95, 71-100, 71-123, 100-15, 100-40, and 101-5.

preplanned air support (JP 1-02, NATO) — Air support in accordance with a program, planned in advance of operations.

preposition (JP 1-02, NATO) — To place military units, equipment, or supplies at or near the point of planned use or at a designated location to reduce reaction time, and to ensure timely support of a specific force during initial phases of an operation. See FM 100-5.

prepositioned supplies — Supplies located at or near the point of planned use or at other designated locations to reduce reaction time and to ensure resupply.

prescribed load — The quantity of combat essential supplies and repair parts (other than ammunition) authorized by major commanders to be on hand in units and which is carried by individuals or on unit vehicles. The prescribed load is continuously reconstituted as used.

preventive maintenance (PM) (JP 1-02) — The care and servicing by personnel for the purpose of maintaining equipment and facilities in satisfactory operating condition by providing for systematic inspection, detection, and correction of incipient failures either before they occur or before they develop into major defects. (See also preventive maintenance, checks, and services.)

preventive maintenance checks and services (PMCS) — Operator-level maintenance conducted before, during, and after equipment operations to identify actual and potential problems and to make repairs in a timely manner to minimize equipment downtime. See FMs 1-111, 7-90, 7-91, 17-12, 23-1, and 63-20.

preventive medicine (PVNTMED) — Measures to counter the medical threat and prevent disease and injury.

primary position — A place for a weapon, a unit, or an individual to fight that provides the best means to accomplish the assigned mission. (See also alternate position, battle position (BP), position, subsequent position, successive positions, and supplementary position.) See FMs 1-111, 6-20, 7-20, 7-30, 17-95, 71-100, 71-123, 100-15, 100-40, and 101-5.

prime mover (JP 1-02) — A vehicle, including heavy construction equipment, possessing military characteristics, designed primarily for towing heavy, wheeled weapons and frequently providing facilities for the transportation of the crew of, and ammunition for, the weapon.

principal direction of fire (PDF) — The direction of fire assigned or designated as the main direction in which a weapon will be oriented. It is selected based on the enemy, mission, terrain, and weapons capability.

OPERATIONAL TERMS AND GRAPHICS ---

principles of war — Principles that guide warfighting at the strategic, operational, and tactical levels. They are the enduring bedrock of US military doctrine. See FM 100-5.

priority of effort — The element designated by the commander to receive a higher concentration of support assets for the duration that it remains the priority of effort. See FM 101-5.

priority of fires — The organization and employment of fire support means according to the importance of the supported unit's missions. See FM 6-series.

priority intelligence requirements (PIR) (JP 1-02, NATO) — Those intelligence requirements for which a commander has an anticipated and stated priority in his task of planning and decisionmaking. (See also information requirements (IR) and commander's critical information requirements (CCIR).) See FM 34-1.

priority message (JP 1-02) — A category of precedence reserved for messages that require expeditious action by the addressee(s) and/or furnish essential information for the conduct of operations in progress when routine precedence will not suffice. (See also precedence.)

priority of support — Priorities set by the commander in his concept of operations and during execution to ensure that combat support and combat service support are provided to subordinate elements in accordance with their relative importance to accomplishing the mission. See FM 100-10.

priority target — A target on which the delivery of fires takes precedence over all the fires for the designated firing unit or element. The firing unit or element will prepare, to the extent possible, for the engagement of such targets. A firing unit or element may be assigned only one priority target. The designation may be based on either time or importance. See FM 6-series.

prisoner of war (PW) (JP 1-02) — A detained person as defined in Articles 4 and 5 of the Geneva Convention Relative to the Treatment of Prisoners of War of August 12, 1949. In particular, one who, while engaged in combat under orders of his or her government, is captured by the armed forces of the enemy. As such, he or she is entitled to the combatant's privilege of immunity from the municipal law of the capturing state for warlike acts which do not amount to breaches of the law of armed conflict. For example, a prisoner of war may be, but is not limited to, any person belonging to one of the following categories who has fallen into the power of the enemy: a member of the armed forces, organized militia or volunteer corps; a person who accompanies the armed forces without actually being a member thereof; a member of a merchant marine or civilian aircraft crew not qualifying for more favorable treatment; or individuals who, on the approach of the enemy, spontaneously take up arms to resist the invading forces. See FM 19-1.

private voluntary organizations (PVO) (JP 1-02) — Private, nonprofit humanitarian assistance organizations involved in development and relief activities. PVOs are normally US-based. "Private voluntary organization" is often used synonymously with the term "nongovernmental organization." (See also nongovernmental organization (NGO).) See FM 100-20 and JP 3-07. **D-8**

probability — The likelihood that an event will occur.

probable line of deployment (PLD) — A line selected on the ground, usually the last covered and concealed position prior to the objective and forward of the line of departure, where attacking units deploy prior to beginning an assault; it is generally used under conditions of limited visibility. See FMs 1-111, 6-20, 7-20, 7-30, 17-95, 71-100, 71-123, 100-15, and 101-5. **3-18**

program of targets — A number of planned targets of a similar nature. A program of targets identified by a code name may be initiated on call, at a specified time, or when a particular event occurs. Targets are fired in a predetermined sequence.

proliferation (nuclear weapons) (JP 1-02) — The process by which one nation after another comes into possession of, or into the right to determine the use of nuclear weapons, each potentially able to launch a nuclear attack upon another nation. See FM 100-30.

propaganda (JP 1-02) — Any form of communication in support of national objectives designed to influence the opinions, emotions, attitudes, or behavior of any group in order to benefit the sponsor, either directly or indirectly. **D-1** **D-2** **D-6**

protect — **1.** A tactical task to prevent observation of or engagement or interference with, a force or location. **2.** All actions taken to guard against espionage or capture of sensitive equipment and information. (See also guard.) See FM 17-95.

protecting smoke — Smoke produced to defeat or degrade target acquisition, guidance systems, or directed-energy weapons. It includes the smoke blanket and smoke curtain. See FM 3-50. **3-24**

protective obstacles — Obstacles employed to assist a unit in its local, close-in protection. (See also obstacle.) See FM 90-7.

psychological operations (PSYOP) (JP 1-02) — Planned operations to convey selected information and indicators to foreign audiences to influence their emotions, motives, objective reasoning, and ultimately the behavior of foreign governments, organizations, groups, and individuals. The purpose of psychological operations is to induce or reinforce foreign attitudes and behavior favorable to the originator's objectives. **4-30** **D-6**

psychological warfare (JP 1-02) — The planned use of propaganda and other psychological actions having the primary purpose of influencing the opinions, emotions, attitudes, and behavior of hostile foreign groups in such a way as to support the achievement of national objectives.

public affairs (JP 1-02) — Those public information and community relations activities directed toward the general public by the various elements of the Department of Defense. **4-27**

pull — The need for a user of information or supplies to request each item individually and wait for the higher unit to furnish the items or fill the request.

purpose (Army) — The desired or intended result of the tactical operation stated in terms relating to the enemy or to the desired situation (for example, to allow passage of follow-on forces or to set the conditions for the counterattack). It is the why of the mission statement expressed using an action verb. (For example, allow, cause, influence, prevent, protect). (See also battle command, battlefield visualization, and concept of operations.) See FMs 100-5 and 101-5.

pursuit (JP 1-02, NATO) — An offensive operation designed to catch or cut off a hostile force attempting to escape, with the aim of destroying it. (See also offensive operations.)

push — **1.** In intelligence and communications, the broadcasting of information to multiple stations simultaneously without the need for them to request or interrogate the host system. **2.** In logistics, the delivery of a predetermined amount of supplies to a user on a scheduled basis without the user requesting them.

Q

quadrant elevation (JP 1-02, NATO) — The angle between the horizontal plane and the axis of the bore when the weapon is laid. (DOD) It is the algebraic sum of the elevation, angle of site, and complementary angle of site.

quartering party — A group of unit representatives dispatched to a probable new site of operations in advance of the main body to secure, reconnoiter, and organize an area prior to the main body's arrival and occupation. (See also advance party.)

quay(JP 1-02) — A structure of solid construction along a shore or bank which provides berthing and which generally provides cargo-handling facilities. A similar facility of open construction is called a wharf.

R

rad — *See* absorbed dose, centigray (cGy), radiation dose (RAD), and roentgen.

radar beacon (JP 1-02) — A receiver-transmitter combination which sends out a coded signal when triggered by the proper type of pulse, enabling determination of range and bearing information by the interrogating station or aircraft.

radiac (JP 1-02, NATO) — An acronym derived from the words "radioactivity, detection, indication, and computation." It is used as an all-encompassing term to designate various types of radiological measuring instruments or equipment. (This word is normally used as an adjective.) See FM 3-4.

radiation dose (JP 1-02, NATO) — The total amount of ionizing radiation absorbed by material or tissues, expressed in centigray. (DOD) The term radiation dose is often used in the sense of the exposure dose expressed in roentgens, which is a measure of the total amount of ionization that the quantity of radiation could produce in air. This could be distinguished from the absorbed dose, also given in rads, which represents the energy absorbed from the radiation per gram of specified body tissue. Further, the biological dose, in rems, is a measure of the biological effectiveness of the radiation exposure. (See also absorbed dose, exposure dose, and radiation dose rate.) See FMs 3-4, 8-9, 100-30, JPs 3-12.2, and 3-12.3.

radiation dose rate (JP 1-02, NATO) — The radiation dose (dosage) absorbed per unit of time. (DOD) A radiation dose rate can be set at some particular unit of time (e.g., H+1 hour) and would be called H+1 radiation dose rate. (See also radiation dose.)

radiation exposure state (RES) (JP 1-02, NATO) — The condition of a unit, or exceptionally an individual, deduced from the cumulative whole body radiation doses(s) received. It is expressed as a symbol which indicates the potential for future operations and the degree of risk if exposed to additional nuclear radiation.

radiation status (RS) — Criteria to assist the commander in measuring unit exposure to radiation based on total past cumulative dose in centigray (cGy). (See also dose rate, operation exposure guide (OEG), and radiation dose.) See FM 3-1-1.) Categories are as follows: **a. radiation exposure status-0 (RES-0)** — No previous exposure history. **b. radiation exposure status-1 (RES-1)** — Negligible radiation exposure history (greater than 0, but less than 70 cGy). **c. radiation exposure status-2 (RES-2)** — Significant but not a dangerous dose of radiation (greater than 70, but less than 150 cGy). **d. radiation**

exposure status-3 (RES-3) — Unit has already received a dose of radiation which makes further exposure dangerous (greater than 150 cGy).

radio fix (JP 1-02, NATO) — **1.** The locating of a radio transmitter by bearings taken from two or more direction finding stations, the site of the transmitter being at the point of intersection. **2.** The location of a ship or aircraft by determining the direction of radio signals coming to the ship or aircraft from two or more sending stations, the locations of which are known.

radio listening silence — The situation where radios are on and continuously monitored with strict criteria when a station on the radio network is allowed to break silence. For example, “maintain radio listening silence until physical contact with the enemy is made.” (See also radio silence.)

radiological survey (JP 1-02, NATO) — The directed effort to determine the distribution and dose rates of radiation in an area. (See also NBC survey.) See FMs 3-3-1 and 3-19.

radio silence (JP 1-02, NATO) — A condition in which all or certain radio equipment capable of radiation is kept inoperative. (DOD) (Note: In combined or United States Joint or intraservice communications, the frequency bands and/or types of equipment affected will be specified.)

radius of action (JP 1-02, NATO) — The maximum distance a ship, aircraft, or vehicle can travel away from its base along a given course with normal combat load and return without refueling, allowing for all safety and operating factors.

radius of damage (RD) (JP 1-02) — The distance from ground zero at which there is a 0.50 probability of achieving the desired damage. (See also collateral damage.) See FM 100-30, JPs 3-12.1, 3-12.2, and 3-12.3.

radius of vulnerability (RV) (nuclear) — The radius of a circle about ground zero within which friendly personnel will be exposed to a risk equal to, or greater than, the emergency risk criterion, or within which materiel will be subjected to a 5 percent probability of the specified degree of damage. (See also troop safety (nuclear).) See FM 100-30, JPs 3-12.1, 3-12.2, and 3-12.3.

raid (JP 1-02, NATO) — An operation, usually small scale, involving a swift penetration of hostile territory to secure information, confuse the enemy, or to destroy installations. It ends with a planned withdrawal upon completion of the assigned mission. See FMs 1-111, 6-20, 7-20, 7-30, 17-95, 71-100, 71-123, 100-15, 100-40, and 101-5.

railhead (JP 1-02, NATO) — A point on a railway where loads are transferred between trains and other means of transport. (See also aerial port and seaport.) **4-29**

rally point — An easily identifiable point on the ground at which units can reassemble and reorganize if they become dispersed, or aircrews and passengers can assemble and reorganize following an incident requiring a forced landing. See FM 1-111. **3-26**

range (JP 1-02) — **1.** The distance between any given point and an object or target. **2.** Extent or distance limiting the operation or action of something, such as the range of an aircraft, ship, or gun. **3.** The distance which can be covered over a hard surface by a ground vehicle, with its rated payload, using the fuel in its tank, and its cans normally carried as part of the ground vehicle equipment. **4.** Area equipped for practice in shooting at targets.

OPERATIONAL TERMS AND GRAPHICS

range of military operations — The armed forces conduct operations in three states of environment: peace, conflict, and war. Stability and support operations are conducted normally during peace and conflict. (See also conflict, military operations other than war (MOOTW), peace operations, and stability and support operations (SASO).) See FMs 100-5, 100-19, 100-20, and 100-23.

range probable error — The range error caused by dispersion that will be exceeded as often as not in an infinite number of rounds fired at the same elevation and is one-eighth of the length of the dispersion pattern at its greatest length. The value is given in the firing tables. See FM 6-40.

range spread (JP 1-02) — The technique used to place the mean point of impact of two or more units 100 meters apart on the gun-target line. See FM 6-40.

rate of fire (JP 1-02, NATO) — The number of rounds fired per weapon per minute.

rate of march (JP 1-02, NATO) — The average number of miles or kilometers to be traveled in a given period of time, including all ordered halts. It is expressed in miles or kilometers per hour.

ready (JP 1-02, NATO) — The term used to indicate that a weapon(s) is loaded, aimed, and prepared to fire.

real time (JP 1-02, NATO) — Pertaining to the timeliness of data or information which has been delayed only by the time required for electronic communication. This implies that there are no noticeable delays. (See also near real time.)

rear area (JP 1-02) — For any particular command, the area extending forward from its rear boundary to the rear of the area assigned to the next lower level of command. This area is provided primarily for the performance of support functions. (See also brigade support area (BSA) and division support area (DSA).) See FMs 100-5, 101-5, 100-15, and 100-40.

rear area operations center (RAOC)/rear tactical operations center (JP 1-02) — A command and control facility that serves as an area/subarea commander's planning, coordinating, monitoring, advising, and directing agency for area security operations.

rear area response forces — Forces responsible for rear area threats beyond the capability of base defenses. (See also security operations.)

rear area threat levels — Levels of response to threat activities. (See rear area response forces.) **a. level I** — Threats that can be defeated by base or base cluster self-defense measures. **b. level II** — Threats that are beyond base or base cluster self-defense capabilities but can be defeated by response forces, normally military police, with supporting fires. **c. level III** — Threats that necessitate the command decision to commit a combined arms tactical combat force to defeat them.

rear assembly area (RAA) — An assembly area occupied by a unit farthest to the unit's rear that normally is within 10 to 15 kilometers of the division forward assembly area and is controlled by the rear command post. Fire support may be provided to the RAA by either division artillery or the aviation brigade. Units within the RAA secure all routes through their assigned areas. See FMs 1-115 and 71-100-3. **3-10**

rear boundary — Line that defines the rear of a sector or zone of action assigned to a particular unit. The area behind the rear boundary belongs to the next higher commander and positioning of elements behind it must be coordinated with that commander. (See also boundary.) **3-11**

rear command post (Army) — Those staff activities concerned primarily with combat service support (CSS) of the force, administrative support of the headquarters, and other activities not immediately concerned with current operations. Typical representatives within the rear echelon are elements of the G1 and G4 sections, G5, adjutant general, staff judge advocate, inspector general, surgeon, provost marshal, supporting military intelligence elements concerned with counterintelligence and prisoner of war interrogation activities, and the tactical airlift representative of the tactical air control party. Normally rear CPs are near or collocated with CSS units (for example, the COSCOM). (See also command post (CP).) **A-3**

rear detachment command post — See command post.

rear echelon (JP 1-02, NATO) — Elements of a force which are not required in the objective area. (Army) — Generic term used to describe all elements normally located in the rear area.

rear guard (JP 1-02) — Security detachment that protects the rear of a column from hostile forces. During a withdrawal, it delays the enemy by armed resistance, destroying bridges, and blocking roads. (Army) — **1.** The rearmost elements of an advancing or a withdrawing force. It has the following functions: to protect the rear of a column from hostile forces; during the withdrawal, to delay the enemy; during the advance, to keep supply routes open. **2.** Security detachment which a moving ground force details to the rear to keep it informed and covered. (See also guard and security operations.) **C-11**

rearming (JP 1-02) — **1.** An operation that replenishes the prescribed stores of ammunition, bombs, and other armament items for an aircraft, naval ship, tank, or armored vehicle, including replacement of defective ordnance equipment, in order to make it ready for combat service. **2.** Resetting the fuze on a bomb, or on an artillery, mortar, or rocket projectile, so that it will detonate at the desired time.

rearm, refuel, and resupply point (R³P) — A designated point through which a unit passes where it receives fuel, ammunition, and other necessary supplies to continue combat operations. See FM 6-50. **3-38**

rear operations (Army) — Those actions, including area damage control, taken by all units (combat, combat support, combat service support, and host nation), singly or in a combined effort, to secure the force, neutralize or defeat enemy operations in the rear area, and ensure freedom of action in the deep and close-in operations. Rear operations are part of operations in depth.

rebuild (JP 1-02) — The restoration of an item to a standard as nearly as possible to its original condition in appearance, performance, and life expectancy. See FMs 100-5 and 100-15.

reception (JP 1-02) — **1.** All ground arrangements connected with the delivery and disposition of air or sea drops. Includes selection and preparation of site, signals for warning and approach, facilitation of secure departure of agents, speedy collection of delivered articles, and their prompt removal to storage places having maximum security. When a group is involved, it may be called a reception committee. **2.** Arrangements to welcome and provide secure quarters or transportation for defectors, escapees, evaders, or incoming agents.

recoilless rifle (heavy) (JP 1-02) — A weapon capable of being fired from either a ground mount or from a vehicle, and capable of destroying tanks. (Army) — A weapon which expels the gases produced by the combustion of the projectile propellant to the rear in order to cause the weapon system and operator to remain relatively stationary. This creates a hazard to the rear of the weapon which must be planned for when the weapon is positioned.

OPERATIONAL TERMS AND GRAPHICS

reconnaissance (recon) (recce) (JP 1-02, NATO) — A mission undertaken to obtain, by visual observation or other detection methods, information about the activities and resources of an enemy or potential enemy, or to secure data concerning the meteorological, hydrographic, or geographic characteristics of a particular area. (Army) — **1.** An operation designed to obtain information on the enemy, potential enemy, or the characteristics of a particular area. The precursor to all operations, which may be accomplished through passive surveillance, technical means, or human interaction (spies or human intelligence (HUMINT)), or through fighting for information. Forms of reconnaissance include route reconnaissance, zone reconnaissance, area reconnaissance, and reconnaissance in force. **2.** NBC reconnaissance may operate with other reconnaissance forces. The NBC reconnaissance uses special equipment to determine the absence or presence and extent of nuclear, chemical, or biological contamination. **3.** Engineer reconnaissance may operate with other reconnaissance forces. Engineer reconnaissance focuses on the requirements to clear obstacles or improve routes, fords, bridges, and so forth, to assist in the uninterrupted movement of the main body force. In military operations other than war (MOOTW), the information is used to task assets to improve the state of services, such as to prepare for rubble removal, erect temporary shelter, and provide improved sanitation. See FMs 1-111, 3-19, 6-20, 7-20, 7-30, 17-95, 71-123, 71-100, 100-5, 101-5, and 5-101. **4-9, 4-18**

reconnaissance by fire (JP 1-02, NATO) — A method of reconnaissance in which fire is placed on a suspected enemy position to cause the enemy to disclose a presence by movement or return of fire. See FMs 5-36, 71-100-2, 100-5, and 101-5.

reconnaissance in force (JP 1-02, NATO) — An offensive operation designed to discover and/or test the enemy's strength or to obtain other information. (Army) — A form of reconnaissance operation designed to discover or test the enemy's strength or to obtain other information. See FMs 1-111, 6-20, 7-20, 7-30, 17-95, 71-100, 71-123, 100-15, 100-40, and 101-5.

reconnaissance-pull— Reconnaissance determines which routes are suitable for maneuver, where the enemy is strong and weak, and where gaps exist. Thus, reconnaissance should pull the main body toward and along the path of least resistance. This facilitates the division's initiative and agility. Reconnaissance-pull is also valid in defensive operations. Reconnaissance determines which routes the enemy is using, where the enemy is strong and weak, and where gaps exist. Thus, reconnaissance enhances agility by identifying opportunities and pulling the division along the path of least resistance to mass the division's combat power at the critical time and place. See FM 71-100-2.

reconnaissance and surveillance plan — A plan prepared by the G2 or S2, in close coordination with the G3 or S3, that assigns tasks to subordinates to develop information which satisfies the intelligence requirements the commander has established. It will focus assets on the targeted areas of interest and named areas of interest. See FMs 34-10-2, 34-130, and 101-5.

reconstitution — Those actions that commanders plan and implement to restore units to a desired level of combat effectiveness commensurate with mission requirements and available resources. Reconstitution operations include regeneration and reorganization. See FMs 63-2, 71-100, 71-100-1/2/3, 100-9, 100-10, and 100-15.

reconstitution site (JP 1-02) — A location selected by the surviving command authority as the site at which a damaged or destroyed headquarters can be reformed from survivors of the attack and/or personnel from other sources, predesignated as replacements.

recovery operations — Extricating damaged or disabled equipment and moving it to locations where repairs can be made. Recovery is the primary responsibility of the using unit.

recovery site (JP 1-02) — In evasion and escape usage, an area from which an evader or an escapee can be evacuated.

redeployment (JP 1-02) — The transfer of a unit, an individual, or supplies deployed in one area to another area, or to another location within the area, or to the zone of interior for the purpose of further employment.

reduce— **1.** A tactical task to gain control over an enemy position or objective. **2.** A task to create lanes through or over an obstacle sufficient to allow the attacking force to accomplish its mission.

refuel on the move (ROM) — An operation to ensure fuel tanks on combat and fuel-servicing vehicles are full before they arrive in the unit's tactical assembly area. See FM 71-123. **3-39**

refugee (JP 1-02) — A civilian who, by reason of real or imagined danger, has left home to seek safety elsewhere. See FM 100-20. **D-1**

regeneration — Rebuilding of a unit through large-scale replacement of personnel, equipment, and supplies, including the reestablishment or replacement of essential command and control and the conduct of mission essential training for the newly rebuilt unit. See FM 100-9.

regimental landing team (JP 1-02) — A task organization for landing comprised of an infantry regiment reinforced by those elements which are required for initiation of its combat function ashore.

registration fire (JP 1-02, NATO) — Fire delivered to obtain accurate data for subsequent effective engagement of targets. See FMs 6-series and 7-90.

registration point (JP 1-02, NATO) — Terrain feature or other designated point on which fire is adjusted for the purpose of obtaining corrections to firing data.

regulated item (JP 1-02, NATO) — Any item whose issue to a user is subject to control by an appropriate authority for reasons that may include cost, scarcity, technical or hazardous nature, or operational significance.

rehearsal — The process of practicing a plan before actual execution. Rehearsals assist units in clarifying the scheme of maneuver, synchronizing the battlefield operating systems, orienting subordinates to the positions and actions of other units, and practicing any possible branches and sequels from the decision support matrix. The rehearsal should not be allowed to digress into a war game. If the commander identifies problems with the synchronization, he should direct a rehearsal after the issues are resolved to ensure all participants clearly understand the required actions. (See also backbrief, confirmation brief, and war game.) See FM 101-5

reinforce (R) (+) — A mission in which one unit augments the capability of another similar-type unit. (See also direct support, general support, and general support-reinforcing.) See FMs 1-111, 6-20, 7-20, 7-30, 17-95, 71-100, 71-123, 100-15, 100-40, and 101-5.

reinforcing (R) (+) (JP 1-02, NATO) — In artillery usage, tactical mission in which one artillery unit augments the fire of another artillery unit. (See also direct support (DS), general-support (GS), and general support reinforcing (GSR).) See FMs 1-111, 6-20, 7-20, 7-30, 17-95, 71-100, 71-123, 100-15, 100-40, and 101-5.

OPERATIONAL TERMS AND GRAPHICS

- reinforcing obstacles** (JP 1-02) — Those obstacles specifically constructed, emplaced, or detonated through military effort and designed to strengthen existing terrain to disrupt, fix, turn, or block enemy movement. (See also obstacle.) See FM 90-7.
- release line (RL)** — Phase line used in river-crossing operations that delineates a change in the headquarters controlling movement. **3-20**
- release point (road) (RP)** (JP 1-02) — A well-defined point on a route at which the elements composing a column return under the authority of their respective commanders, each one of these elements continuing its movement toward its own appropriate destination. (See also lane, march column, march serial, march unit, route, or start point (SP).) See FMs 1-111, 6-20, 7-20, 7-30, 17-95, 55-10, 71-100, 71-123, 100-15, 100-40, and 101-5. **3-26**
- relief in place (RIP)** (JP 1-02, NATO) — An operation in which, by direction of higher authority, all or part of a unit is replaced in an area by the incoming unit. The responsibilities of the replaced elements for the mission and the assigned zone of operations are transferred to the incoming unit. The incoming unit continues the operation as ordered. **C-10**
- religious ministry support** (JP 1-02) — The entire spectrum of professional duties to include providing for or facilitating essential religious needs and practices, pastoral care, family support programs, religious education, volunteer and community activities, and programs performed to enhance morale and moral, ethical, and personal well-being. Enlisted religious support personnel assist the chaplain in providing religious ministry support.
- reorganization** — Action taken to shift internal resources within a degraded unit to increase its level of combat effectiveness. See FMs 7-7, 7-8, 7-20 and 100-9.
- repair**(JP 1-02) — The restoration of an item to serviceable condition through correction of a specific failure or unserviceable condition.
- repeat**(JP 1-02, NATO) — In artillery and naval gunfire support, an order or request to fire again the same number of rounds with the same method of fire. See FMs 6-series and 7-90.
- required supply rate (RSR) (ammunition)** (JP 1-02) — In Army usage, the amount of ammunition expressed in terms of rounds per weapon per day for ammunition items fired by weapons, and in terms of other units of measure per day for bulk allotment and other items, estimated to be required to sustain operations of any designated force without restriction for a specified period. Tactical commanders use this rate to state their requirements for ammunition to support planned tactical operations at specified intervals. The required supply rate is submitted through command channels. It is consolidated at each echelon and is considered by each commander in subsequently determining the controlled supply rate within the command. (See also controlled supply rate (CSR).) See FMs 9-6 and 100-10.
- reserve**(JP 1-02) — **1.** Portion of a body of troops which is kept to the rear, or withheld from action at the beginning of an engagement, available for a decisive movement. **2.** Members of the Military Services who are not in active service but who are subject to call to active duty. **3.** Portion of an appropriation or contract authorization held or set aside for future operations or contingencies and in respect to which administrative authorization to incur commitments or obligations has been withheld. (Army) — That portion of a force withheld from action or uncommitted to a specific course of action, so as to be available for commitment at the decisive moment. Its primary purpose is to retain flexibility through offensive action. (See also committed force and uncommitted force.) See FMs 1-111, 6-20, 7-20, 7-30, 17-95, 71-100, 71-123, 100-15, and 101-5.

reserved demolition target (JP 1-02, NATO) — A target for demolition, the destruction of which must be controlled at a specific level of command because it plays a vital part in the tactical or strategical plan, or because of the importance of the structure itself, or because the demolition may be executed in the face of the enemy. (See also reserved obstacles.) See FM 90-7.

reserved obstacles (JP 1-02) — Those demolition obstacles that are deemed critical to the plan for which the authority to detonate is reserved by the designating commander. (Army) — Obstacles, of any type, for which the commander restricts execution authority. See FM 90-7.

reserved route (JP 1-02, NATO) — In road traffic, a specific route allocated exclusively to an authority or formation. See FM 55-10.

residual radioactivity (JP 1-02) — Nuclear radiation that results from radioactive sources and which persist for longer than one minute. Sources of residual radioactivity created by nuclear explosions include fission fragments and radioactive matter created primarily by neutron activation, but also by gamma and other radiation activation. Other possible sources of residual radioactivity include radioactive material created and dispersed by means other than nuclear explosion. (See also contamination, induced radiation (nuclear), and initial nuclear effects.) See FM 100-30, JPs 3-12.3, and 3-12.2.

residual risk — The level of risk remaining after controls have been identified and selected for hazards that may result in loss of combat power. Controls are identified and selected until residual risk is at an acceptable level or until it cannot be practically reduced further.

response force (JP 1-02) — A mobile force with appropriate fire support designated, usually by the area commander, to deal with Level II threats in the rear area. (Army) — Normally a military police function. See FMs 19-1, 71-100, and 100-15.

restoration — The systematic removal of pollution or contaminants from the environment, especially from the soil or ground water, by physical, chemical, or biological means. Restoration is also known as remediation or environmental cleanup.

restricted operations zone (ROZ) (Army) — A volume of airspace of defined dimensions designated for a specific operational mission. Entry into that zone is authorized only by the originating headquarters. See FM 100-103. **3-6**

restrictive fire area (RFA) — An area in which specific restrictions are imposed and into which fires that exceed those restrictions may not be delivered without prior coordination with the establishing headquarters. See FM 6-series. **3-22**

restrictive fire line (RFL) — A line established between converging friendly forces (one or both may be moving) that prohibits fires or effects from fires across the line without coordination with the affected force. It is established by the next higher common commander of the converging forces. See FMs 7-20, 17-95, 71-100, and 100-15. **3-22**

resupply (JP 1-02, NATO) — The act of replenishing stocks in order to maintain required levels of supply. See FM 100-10.

retain (JP 1-02) — When used in the context of deliberate planning, the directed command will keep the referenced operation plan, operation plan in concept format, or concept summary and any associated Joint Operation Planning System or Joint Operation Planning and Execution System automated data processing files in an inactive library or status. The plan and its associated files will not be maintained unless

OPERATIONAL TERMS AND GRAPHICS

directed by follow-on guidance. (Army) — A tactical task to occupy and hold a terrain feature to ensure it is free of enemy occupation or use. See FMs 1-111, 6-20, 7-20, 7-30, 17-95, 71-100, 71-123, 100-15, 100-40, and 101-5. **C-10**

retirement(JP 1-02, NATO) — An operation in which a force out of contact moves away from the enemy. (Army) — A form of retrograde operations; a directed, rearward movement by a force that is not in contact with the enemy and does not anticipate significant contact with the enemy. See FMs 1-111, 6-20, 7-20, 7-30, 17-95, 71-100, 71-123, 100-15, and 101-5. **C-10**

retrograde — A type of operation in which a unit conducts a directed, organized movement to the rear or away from the enemy. Forms of retrograde include delay, withdrawal, and retirement. (See also delaying operation.) See FMs 1-111, 6-20, 7-20, 7-30, 17-95, 71-100, 71-123, 100-15, and 101-5.

retrograde movement (JP 1-02) — Any movement of a command to the rear, or away from the enemy. It may be forced by the enemy or may be made voluntarily. Such movements may be classified as withdrawal, retirement, or delaying action. (See also delaying operation.) See FMs 1-111, 6-20, 7-20, 7-30, 17-95, 71-100, 71-123, 100-15, and 101-5.

reverse slope — Any slope which descends away from the enemy.

revolutionary(JP 1-02) — An individual attempting to effect a social or political change through the use of extreme measures. (See also antiterrorism (AT).) See FM 100-20.

riot control agent (RCA) (JP 1-02) — A substance that produces temporary irritating or disabling physical effects that disappear within minutes of removal from exposure. There is no significant risk of permanent injury, and medical treatment is rarely required. (Army) — A compound that produces temporary irritating or incapacitating effects when used in field concentrations. Such compounds include tearing (crying), sneezing, and vomiting agents. See FM 3-9.

risk — Chance of hazard or bad consequences; exposure to chance of injury or loss. Risk level is expressed in terms of hazard probability or severity.

risk assessment — The identification and assessment of hazards (first two steps of risk management process).

risk decision — The decision to accept or not accept the risk(s) associated with an action; made by the commander, leader, or individual responsible for performing that action.

risk management — The process of detecting, assessing, and controlling risk arising from operational factors and making decisions that balance risk costs with mission benefits. The five steps of risk management are identify the hazards, assess the hazards, develop controls and make risk decision, implement controls, and supervise and evaluate. (See controls, exposure, hazard, probability, residual risk, risk, risk assessment, risk decision, and severity) See FM 1-100.

river crossing — An operation required before ground combat power can be projected and sustained across a water obstacle. It is a centrally planned and controlled offensive operation that requires the allocation of external crossing means and a force dedicated to the security of the bridgehead. (See also deliberate crossing and hasty crossing.) See FM 90-13. **3-28**

riverine area (JP 1-02) — An inland or coastal area comprising both land and water, characterized by limited land lines of communication, with extensive water surface and/or inland waterways that provide natural routes for surface transportation and communications. See FM 100-40.

riverine operations (JP 1-02) — Operations conducted by forces organized to cope with and exploit the unique characteristics of a riverine area, to locate and destroy hostile forces, and/or to achieve, or maintain control of the riverine area. Joint riverine operations combine land, naval, and air operations, as appropriate, and are suited to the nature of the specific riverine area in which operations are to be conducted. See FM 100-40.

roadblock (JP 1-02, NATO) — A barrier or obstacle (usually covered by fire) used to block, or limit the movement of, hostile vehicles along a route. See FM 5-102. **3-31, 3-32**

road clearance time (JP 1-02, NATO) — The total time a column requires to travel over and clear a section of the road. See FMs 55-10 and 55-30.

roentgen(JP 1-02, NATO) — A unit of exposure dose of gamma (or X-) radiation. In field dosimetry, one roentgen is essentially equal to one rad. (Army) — An obsolete term for a unit of radiation dosage equal to the quantity of ionizing radiation that will produce one electrostatic unit of electricity in one cubic centimeter of dry air at zero degrees Celcius and standard atmospheric pressure. (See also centigray (cGy) and dose rate.) See FM 3-9.

rounds complete (JP 1-02, NATO) — In artillery and naval gunfire support, the term used to report that the number of rounds specified in fire for effect have been fired. (See also shot.) See FMs 6-series and 7-90.

route(JP 1-02, NATO) — The prescribed course to be traveled from a specific point of origin to a specific destination. See FMs 55-10, 55-30, and 100-103.

route capacity (JP 1-02, NATO) — **1.** The maximum traffic flow of vehicles in one direction at the most restricted point on the route. **2.** The maximum number of metric tons which can be moved in one direction over a particular route in one hour. It is the product of the maximum traffic flow and the average payload of the vehicles using the route. See FM 55-10.

route classification (JP 1-02, NATO) — Classification assigned to a route using factors of minimum width and worst route type; least bridge, raft, or culvert military load classification; and obstructions to traffic flow. (See also military load classification (MLC).) See FMs 5-36 and 17-95.

route reconnaissance — A form of reconnaissance focused along a specific line of communications, such as a road, railway, or waterway, to provide new or updated information on route conditions and activities along the route. See FMs 5-36 and 17-95.

rules of engagement (ROE) (JP 1-02) — Directives issued by competent military authority which delineate the circumstances and limitations under which US forces will initiate and/or continue combat engagement with other forces encountered. See FM 100-20.

rules of interaction (ROI) (Army) — Rules that guide those human dimension skills required to successfully interface with the myriad of players often present in stability and support operations. These guidelines govern interpersonal communications skills, extent and form of soldier's persuasion, negotiation, and communication techniques. Their purpose is to reduce hostile confrontation. Rules of interaction are founded on firm rules of engagement. Together they provide the soldier a tool to deal with nontraditional

OPERATIONAL TERMS AND GRAPHICS

threats such as political friction, ideologies, cultural idiosyncrasies, and religious beliefs and rituals. See FM 100-20.

rupture — A task to create a gap in enemy defensive positions quickly. (See also breach and reduce.)

ruse (Army) — A technique of deception operations designed to deceive the enemy, characterized by deliberately exposing false information to the collection means of the enemy, thereby obtaining an advantage. This can be done by any means, including electronic signals and signatures, dummy positions, dummy vehicles and facilities, or misleading troop and force movements. (See also deception operation.)

S

sabotage (JP 1-02) — An act or acts with intent to injure, interfere with, or obstruct the national defense of a country by willfully injuring or destroying, or attempting to injure or destroy, any national defense or war material, premises, or utilities, to include human and natural resources. (See also terrorism.) See FMs 19-1 and 100-20.

safe area (JP 1-02) — A designated area in hostile territory that offers the evader or escapee a reasonable chance of avoiding capture and of surviving until he can be evacuated.

safe house (JP 1-02) — An innocent-appearing house or premises established by an organization for the purpose of conducting clandestine or covert activity in relative security. See FM 100-20. **D-2, D-7**

salient — A protrusion or bulge in the trace of the forward line of friendly troops toward or into an enemy area of operations or on the outside bend of a river. See FM 100-40.

salvage (JP 1-02) — **1.** Property that has some value in excess of its basic material content but which is in such condition that it has no reasonable prospect of use for any purpose as a unit and its repair or rehabilitation for use as a unit is clearly impractical. **2.** The saving or rescuing of condemned, discarded, or abandoned property, and of materials contained therein for reuse, refabrication, or scrapping. **4-27**

scatterable mine (JP 1-02, NATO) — In land mine warfare, a mine laid without regard to classical pattern and which is designed to be delivered by aircraft, artillery, missile, ground dispenser, or by hand. Once laid, it normally has a limited life. See FM 20-32. **3-30**

scheduled fire (JP 1-02, NATO) — A type of prearranged fire executed at a predetermined time. See FMs 6-series and 7-90.

scheduled supplies — Requirements that can be reasonably predicted. A scheduled supply normally will not require a requisition to be submitted by the user for its replenishment. Requirements are based on troop strength, equipment density, forecasts, and daily usage factors. Supply classes I, III (bulk), V, and VI normally are treated as scheduled supplies. See FM 100-10.

scheduled target (JP 1-02, NATO) — In artillery and naval gunfire support, a planned target on which fire is to be delivered at a specific time. (See also on-call target.) See FMs 6-series and 7-90.

schedule of fire (JP 1-02) — Groups of fires or series of fires fired in a definite sequence according to a definite program. The time of starting the schedule may be ON CALL. For identification purposes schedules may be referred to by a code name or other designation. See FMs 6-series and 7-90.

schedule of targets (JP 1-02, NATO) — In artillery and naval gunfire support, individual targets, groups or series of targets to be fired on, in a definite sequence according to a definite program. See FMs 6-series and 7-90.

scheme of maneuver (JP 1-02) — The tactical plan to be executed by a force in order to seize assigned objectives. See FM 101-5.

scientific and technical intelligence (JP 1-02) — The product resulting from the collection, evaluation, analysis, and interpretation of foreign scientific and technical information which covers: **a.** foreign developments in basic and applied research and in applied engineering techniques; and **b.** scientific and technical characteristics, capabilities, and limitations of all foreign military systems, weapons, weapon systems, and materiel, the research and development related thereto, and the production methods employed for their manufacture. See FM 34-2.

screen (JP 1-02, NATO) — **1.** An arrangement of ships, aircraft, and/or submarines to protect a main body or convoy. **2.** In cartography, a sheet of transparent film, glass, or plastic carrying a "ruling" or other regularly repeated pattern which may be used in conjunction with a mask, either photographically or photomechanically, to produce areas of the pattern. **3.** In surveillance, camouflage, and concealment, any natural or artificial material, opaque to surveillance sensor(s), interposed between the sensor(s) and the object to be camouflaged or concealed. **4.** A security element whose primary task is to observe, identify and report information, and which only fights in self-protection. (Army) — A task to maintain surveillance; provide early warning to the main body; or impede, destroy, and harass enemy reconnaissance within its capability without becoming decisively engaged. (See also security operations.) See FMs 1-111, 6-20, 7-20, 7-30, 17-95, 71-100, 71-123, 100-15, and 101-5. **C-II**

screen line — A control measure, usually named as a phase line (PL), established forward of the main body during defensive operations. Once occupied it becomes the forward line of own troops (FLOT) and the limit of advance (LOA) for all friendly forces although permission can be obtained from the establishing headquarters to go beyond it. (See also screen and security operations.) See FMs 7-30, 17-95, 71-100, and 100-15.

seaport — A place at which ships may discharge or receive their cargoes. (See also aerial ports.) See FM 55-10. **4-29**

seaport of debarkation (SPOD) — A marine terminal for sustained port operations at which personnel and material are discharged from ships. SPODs normally act as ports of embarkation on return passenger and retrograde cargo shipments. **4-29**

seaport of embarkation (SPOE) — A marine terminal for sustained port operations at which personnel board and materiel is loaded aboard ships. SPOEs normally act as ports of debarkation on return passenger and retrograde cargo shipments. **4-29**

search and attack — A variant of the movement to contact conducted by smaller, light maneuver units and air cavalry or air assault forces in large areas to destroy enemy forces, deny area to the enemy, or collect information. Search and attack operations may be conducted against a dispersed enemy in close terrain unsuitable for armored forces, in rear areas against enemy special operations forces (SOF) or infiltrators, or as an area security mission to clear assigned zones. (See also movement to contact.) See FMs 7-7, 7-10, 7-20, 7-30, 71-100-2, 90-4, and 90-26.

sector(JP 1-02, NATO) — **1.** An area designated by boundaries within which a unit operates, and for which it is responsible. **2.** One of the subdivisions of a coastal frontier. (Army) — Normally, sectors are used

OPERATIONAL TERMS AND GRAPHICS

in defensive operations and have a forward edge of the battle area designated by a higher commander. (See also area of influence and zone of action.) See FMs 1-111, 6-20, 7-20, 7-30, 17-95, 71-100, 71-123, 100-15, and 101-5.

sector of fire (JP 1-02, NATO) — A defined area which is required to be covered by the fire of individual or crew-served weapons or the weapons of a unit. See FMs 7-7, 7-8, 7-91, 17-12, and 23-1.

secure (JP 1-02, NATO) — In an operational context, to gain possession of a position or terrain feature, with or without force, and to make such disposition as will prevent, as far as possible, its destruction or loss by enemy action. (Army) — A tactical task to gain possession of a position or terrain feature, with or without force, and to deploy in a manner which prevents its destruction or loss to enemy action. The attacking force may or may not have to physically occupy the area. **C-10**

security (JP 1-02) — **1.** Measures taken by a military unit, an activity or installation to protect itself against all acts designed to, or that may, impair its effectiveness. **2.** A condition that results from the establishment and maintenance of protective measures that ensure a state of inviolability from hostile acts or influences. **3.** With respect to classified matter, it is the condition that prevents unauthorized persons from having access to official information that is safeguarded in the interests of national security. (NATO) — A condition that results from the establishment of measures which protect designated information, materiel, personnel, systems, components, and equipment against hostile persons, acts, or influences. See FMs 17-95, 71-100, and 100-15.

security area (zone) — Area that begins at the forward area of the battlefield and extends as far to the front and flanks as security forces are deployed. Forces in the security area furnish information on the enemy and delay, deceive, and disrupt the enemy and conduct counterreconnaissance. See FMs 17-95, 71-3, 71-100, and 100-15.

security assistance (JP 1-02) — Group of programs authorized by the Foreign Assistance Act of 1961, as amended, and the Arms Export Control Act of 1976, as amended, or other related statutes by which the United States provides defense articles, military training, and other defense-related services, by grant, loan, credit, or cash sales in furtherance of national policies and objectives. See FM 100-20.

security operations — Those operations designed to provide reaction time, maneuver space, and protection to the main body. Security operations are characterized by aggressive reconnaissance to reduce terrain and enemy unknowns, to gain and maintain contact with the enemy to ensure continuous information, and to provide early and accurate reporting of information to the protected force. Forms of security operations include screen, guard, cover, and area security. Area security operations normally are associated with rear operations. Security operations forces orient on the main body and may be oriented in any direction from a stationary or moving force. (See also screen, guard, cover, and rear area response forces.) See FMs 7-30, 17-95, 71-100, 100-15, and 100-40. **C-11**

seize — A tactical task to clear a designated area and obtain control of it. (See also contain.) See FM 100-40. **C-11**

selective identification feature (SIF) (JP 1-02) — A capability that, when added to the basic identification friend or foe system, provides the means to transmit, receive, and display selected coded replies. (See also identification, friend or foe (IFF), and IFF on/off line.) See FM 1-111.

selective mobilization — *See* mobilization.

semipermissive environment — *See* operational environment.

sensor (JP 1-02, NATO) — An equipment which detects, and may indicate and/or record objects and activities by means of energy or particles emitted, reflected, or modified by objects. **4-9, 4-20**

separation zone (JP 1-02, NATO) — An area between two adjacent horizontal or vertical areas into which units are not to proceed unless certain safety measures can be fulfilled. (See also zone of separation (ZOS).) See FM 100-20.

sequel— Major operations that follow the current major operation. Plans for these are based on the possible outcomes (victory, stalemate, or defeat) associated with the current operation. See FM 101-5.

serial (JP 1-02, NATO) — An element or a group of elements within a series which is given a numerical or alphabetical designation for convenience in planning, scheduling, and control. (Army) — A serial can be a group of people, vehicles, equipment, or supplies and is used in airborne, air assault, and amphibious operations. See FMs 55-10, 71-100-3, 90-26, and 100-40.

serial assignment table (JP 1-02) — A table that is used in amphibious operations and shows the serial number, the title of the unit, the approximate number of personnel; the material, vehicles, or equipment in the serial; the number and type of landing craft and/or amphibious vehicles required to boat the serial; and the ship on which the serial is embarked. (Army) — Also used in airborne and air assault operations and may be used in noncombatant evacuation operations. See FMs 71-100, 71-100-3, and 90-26.

series of targets (NATO, Army) — In fire support, a number of targets and/or group(s) of targets planned in a predetermined time sequence to support a maneuver phase. A series of targets is indicated by a code name or nickname. See FMs 6-series and 7-90. **3-24**

service ammunition (JP 1-02) — Ammunition intended for combat, rather than for training purposes. See FMs 7-91, 9-6, 17-12, and 23-1.

Service component command (JP 1-02) — A command consisting of the Service component commander and all those Service forces, such as individuals, units, detachments, organizations, and installations under the command including the support forces that have been assigned to a combatant command, or further assigned to a subordinate unified command or joint task force. (See also functional component command.) See FM 100-7 and JP 3-0.

severity — The expected consequence of an event in terms of degree of injury, property damage, or other mission-impairing factors (loss of combat power, adverse publicity, and so forth) that could occur.

shallow fording (JP 1-02) — The ability of a self-propelled gun or ground vehicle equipped with built-in waterproofing, with its wheels or tracks in contact with the ground, to negotiate a water obstacle without the use of a special waterproofing kit. (See also ford.)

shaped charge (JP 1-02, NATO) — A charge shaped so as to concentrate its explosive force in a particular direction. (Army) — The high-explosive antitank round is a type of shaped charge. This type charge is used for cutting holes in armor plate or concrete. See FMs 5-series and 9-6.

sheaf (JP 1-02) — In artillery and naval gunfire support, planned planes (lines) of fire that produce a desired pattern of bursts with rounds fired by two or more weapons. See FMs 6-series and 7-90.

shelling report (SHELREP) (JP 1-02, NATO) — Any report of enemy shelling containing information on caliber, direction, time, density and area shelled.

OPERATIONAL TERMS AND GRAPHICS

- shift fire** — The command to move the cone of fire in a direction away from a friendly maneuvering force so that enemy forces continue to be struck by the beaten zone at the same time the friendly unit moves. See FMs 6-series, 7-90, 7-91, 17-12, and 23-1.
- shore party** (JP 1-02, NATO) — A task organization of the landing force, formed for the purpose of facilitating the landing and movement off the beaches of troops, equipment, and supplies; for the evacuation from the beaches of casualties and enemy prisoners of war; and for facilitating the beaching, retraction, and salvaging of landing ships and craft. It comprises elements of both the naval and landing forces. It is also called beach group. See JP 3-02.1.
- short** (JP 1-02, NATO) — In artillery and naval gunfire support, a spotting, or an observation, used by an observer to indicate that a burst(s) occurred short of the target in relation to the spotting line. (Army) — In direct fire, a sensing of a round hitting below the target or between the target and the firing system. See FMs 6-series, 7-90, 7-91, 17-12, and 23-1.
- short-range air defense engagement zone (SHORADEZ)** (JP 1-02) — In air defense, that airspace of defined dimensions within which the responsibility for engagement of air threats normally rests with short-range air defense weapons. It may be established within a low- or high-altitude missile engagement zone. See FMs 44-100 and 100-103.
- short round** (JP 1-02) — **1.** The unintentional or inadvertent delivery of ordnance on friendly troops, installations, or civilians by a friendly weapon system. **2.** A defective cartridge in which the projectile has been seated too deeply. See FMs 6-series, 7-90, 7-91, 17-12, and 23-1.
- shot** (JP 1-02, NATO) — In artillery and naval gunfire support, a report that indicates a gun, or guns, have been fired. (Army) — A message sent to the observer to alert him that rounds for his call for fire are in the air and to be prepared to provide a sensing of the relation of their impact to the target. See FMs 6-series and 7-90.
- show of force** (JP 1-02) — An operation, designed to demonstrate US resolve, that involves increased visibility of US deployed forces in an attempt to defuse a specific situation, which, if allowed to continue, may be detrimental to US interests or national objectives. See also deception.) See FM 100-20.
- signal operating instruction (SOI)** (Army) — Series of orders issued for technical control and coordination of signal support activities of a command.
- signal security (SIGSEC)** (JP 1-02) — A generic term that includes both communications security and electronics security. (Army) — Measures intended to deny or counter hostile exploitation of electronic missions. SIGSEC includes communications security and electronic security. (See also security).
- signals intelligence (SIGINT)** (JP 1-02) — **1.** A category of intelligence comprising either individually or in combination all communications intelligence, electronics intelligence, and foreign instrumentation signals intelligence, however transmitted. **2.** Intelligence derived from communications, electronics, and foreign instrumentation signals. See FM 34-2.
- signature** — The visible or audible effects produced when a weapon is fired or a piece of equipment operated, such as noise, smoke, flame, heat, or debris; also, an electronic emission subject to detection and traceable to the equipment producing it.

simplicity— One of the nine principles of war. The preparation and execution of clear, uncomplicated, and concise orders and plans to facilitate mission execution in the stress, fatigue, and fog of war. See FM 100-5.

simulative electromagnetic deception — Actions to simulate friendly, notional, or actual capabilities to mislead hostile forces. (See also electromagnetic deception, imitative electromagnetic deception, and manipulative electromagnetic deception.)

simultaneous attack in depth — Concurrent firing on or attack of enemy reserves, logistics, headquarters, staging and assembly areas, airfields, and close forces (attacking or defending) by maneuver, fire support, and other combat support units in the close fight and fighting in depth with cannon artillery, rocket or missile artillery (land- and sea-based), attack helicopters, airborne forces, air assault forces, other maneuver and combat support forces, special operations forces, and fighter or bomber aircraft to create a synergistic and paralyzing effect on the enemy. See FMs 71-100, 100-5, and 100-15.

situational obstacle — An obstacle that a unit plans and possibly prepares prior to starting an operation, but does not execute unless specific criteria are met. It provides the commander flexibility for emplacing tactical obstacles based on battlefield development. See FM 90-7.

situation template — A series of projections that portray, based on enemy doctrine, the most probable disposition and location of enemy forces within constraints imposed by weather and terrain. See FMs 34-130 and 101-5.

situation map (SITMAP) (JP 1-02, NATO) — A map showing the tactical or the administrative situation at a particular time. (See also map and overlay.) See FM 101-5.

situation report (SITREP) (JP 1-02, NATO) — A report giving the situation in the area of a reporting unit or formation. (Army) — The format is usually established by unit standard operating procedures.

skin decontamination technique — Process of removing or neutralizing contamination on the skin within one minute of exposure to prevent it from penetrating into the skin. Immediate decontamination techniques are skin decontamination, personal wipedown, and operator's spraydown. See FM 3-5.

slice (JP 1-02) — An average logistic planning factor used to obtain estimates of requirements for personnel and materiel. A personnel slice, e.g., generally consists of the total strength of the stated basic combatant elements, plus its proportionate share of all supporting and higher headquarters personnel. (Army) — The normal apportionment of combat support and combat service support elements allocated to support a maneuver unit. (See also combat multiplier.)

small-scale map — *See* map.

smoke blanket — A dense horizontal concentration of smoke covering an area of ground with visibility inside the concentration less than 50 meters. The blanket is established over and around friendly areas to protect them from air visual observation and visual precision bombing attacks or established over enemy areas to protect attacking friendly aircraft from enemy air defense. See FM 3-50.

smoke curtain — A vertical smoke screen. (See also smoke screen.) See FM 3-50. **3-24**

smoke haze — A light concentration that restricts accurate enemy observation and fire but which is not dense enough to hamper friendly operations (visibility 50 to 150 meters). See FM 3-50. **3-24**

OPERATIONAL TERMS AND GRAPHICS

smoke screen (JP 1-02, NATO) — Cloud of smoke used to mask either friendly or enemy installations or maneuvers. (Army) — The smoke screen is used to conceal ground maneuver, obstacle breaching, recovery operations, amphibious assault operations, as well as key assembly areas, supply routes, and logistical facilities. See FM 3-50. **3-24**

solid waste — Any material or substance (solid or liquid) which is inherently waste-like by being no longer suitable for its originally intended purpose.

sortie (JP 1-02, NATO) — In air operations, an operational flight by one aircraft.

space defense (JP 1-02) — All defensive measures designed to destroy attacking enemy vehicles (including missiles) while in space, or to nullify or reduce the effectiveness of such attack.

space operations — The employment of space system capabilities that provide the means to enhance command and control, facilitate the maneuver of forces, reduce the commander's uncertainty, and improve fire support, air defense, intelligence collection, and combat service support operations which will support strategic, operational, and tactical missions across the operational continuum in the near, mid, and far term. See FM 100-5.

special activities (JP 1-02) — Activities conducted in support of national foreign policy objectives which are planned and executed so that the role of the US Government is not apparent or acknowledged publicly. They are also functions in support of such activities but are not intended to influence United States political processes, public opinion, policies, or media and do not include diplomatic activities or the collection and production of intelligence or related support functions.

special air operation (JP 1-02) — An air operation conducted in support of special operations and other clandestine, covert, and psychological activities. See FM 100-25. **4-30**

special forces operations base (SFOB) (Army) — A base formed and operated by the special forces group from organic and attached resources. It is the focal point for operational, administrative, logistical, and communication support functions. See FM 100-25.

special operations (SO) (JP 1-02) — Operations conducted by specially organized, trained, and equipped military and paramilitary forces to achieve military, political, economic, or psychological objectives by unconventional military means in hostile, denied, or politically sensitive areas. These operations are conducted during peacetime competition, conflict, and war, independently or in coordination with operations of conventional, nonspecial operations forces. Political-military considerations frequently shape special operations, requiring clandestine, covert, or low visibility techniques and oversight at the national level. Special operations differ from conventional operations in degree of physical and political risk, operational techniques, mode of employment, independence from friendly support, and dependence on detailed operational intelligence and indigenous assets. See FM 100-25. **4-29, 4-30**

special operations-peculiar (Army) — Materiel, services, and training for special operations mission support for which there is no broad conventional requirement. See FM 100-25.

special operations forces (SOF) (JP 1-02) — Those active and reserve component forces of the Military Services designated by the Secretary of Defense and specifically organized, trained, and equipped to conduct and support special operations. **4-29, 4-30**

special reconnaissance (Army) — Complementing of national and theater intelligence collection assets and systems by obtaining specific, well-defined, and time-sensitive information of strategic or operational

significance. It may complement other collection methods where there are constraints of weather, terrain-masking, hostile countermeasures, and/or other systems availability. Special reconnaissance is a human intelligence function that places US or US-controlled "eyes on target" in hostile, denied, or politically sensitive territory when authorized. SOF may conduct these missions unilaterally or in support of conventional operations. See JP 3-05.

special staff (JP 1-02) — All staff officers having duties at a headquarters and not included in the general (coordinating) staff group or in the personal staff group. The special staff includes certain technical specialists and heads of services, for example, quartermaster officer, antiaircraft officer, transportation officer, etc. See FM 101-5.

specified command (JP 1-02) — A command that has a broad, continuing mission, normally functional, and is established and so designated by the President through the Secretary of Defense with the advice and assistance of the Chairman of the Joint Chiefs of Staff. It normally is composed of forces from a single Military Department. Also called specified combatant command. See FM 100-5 and JP 5-0.

splash (JP 1-02, NATO) — **1.** In artillery and naval gunfire support, word transmitted to an observer or spotter five seconds before the estimated time of the impact of a salvo or round. **2.** In air interception, target destruction verified by visual or radar means. (See also shot and fire mission.) See FMs 6-series and 7-90.

split-based operation — The dividing of logistics, staff, and management and command functions so that only those functions absolutely necessary are deployed, allowing some logistics, staff, and management and command functions to be accomplished from CONUS or another theater. See FMs 100-7 and 100-10.

spoiling attack (JP 1-02) — A tactical maneuver employed to seriously impair a hostile attack while the enemy is in the process of forming or assembling for an attack. Usually employed by armored units in defense by an attack on enemy assembly positions in front of a main line of resistance or battle position. (Army) — A type of attack executed from a defensive posture to seriously impair a hostile attack by striking the enemy when he is preparing for his own attack and is vulnerable in assembly areas and attack positions. (See also attack.) See FMs 1-111, 6-20, 7-20, 7-30, 17-95, 71-100, 71-123, 100-15, 100-40, and 101-5.

spore— An asexual, usually single-celled, reproductive body of plants such as fungi, mosses, and ferns; a microorganism, as a bacterium, in a resting or dormant state. See FM 3-9.

spot jamming (JP 1-02, NATO) — The jamming of a specific channel or frequency. (See also jamming.) See FM 34-2.

spot report (SPOTREP) (JP 1-02) — A concise narrative report of essential information covering events or conditions that may have an immediate and significant effect on current planning and operations that is afforded the most expeditious means of transmission consistent with requisite security. (Note: In reconnaissance and surveillance usage, spot report is not to be used.) (Army) — The format is usually established by unit standard operating procedures.

stability and support operations (Army) — The use of military capabilities for any purpose other than war. (See also counterdrug, counterinsurgency, domestic emergencies, humanitarian assistance (HA), military operations other than war (MOOTW), and peace operations.) See JP 3-07 and FM 100-20.

OPERATIONAL TERMS AND GRAPHICS

staff estimates (JP 1-02) — Assessments of courses of action by the various staff elements of a command that serve as the foundation of the commander's estimate. (Army) — The staff officer's evaluation of how factors in his particular field of interest will influence the courses of action under consideration by the commander. (See also commander's estimate of the situation.) See FM 101-5.

staging area (JP 1-02, NATO) — **1.** Amphibious or airborne — A general locality between the mounting area and the objective of an amphibious or airborne expedition, through which the expedition or parts thereof pass after mounting, for refueling, regrouping of ships, and/or exercise, inspection, and redistribution of troops. **2.** Other movements — A general locality established for the concentration of troop units and transient personnel between movements over the lines of communications. See FMs 55-10 and 55-30.

staging base (JP 1-02) — **1.** An advanced naval base for the anchoring, fueling, and refitting of transports and cargo ships, and for replenishing mobile service squadrons. **2.** A landing and takeoff area with minimum servicing, supply, and shelter provided for the temporary occupancy of military aircraft during the course of movement from one location to another.

staging field — A predetermined area where aircraft assemble prior to conducting an air assault operation.

staging plan — An air assault operation plan that is based on the loading plan and prescribes the arrival time of the ground units (troops, equipment, and supplies) at the pickup zone in the proper order for movement. See FM 90-4.

standard pattern (JP 1-02, NATO) — In landmine warfare, the agreed pattern to which mines are normally laid. See FMs 5-34, 5-102, and 20-32.

standard use Army aircraft flight route (SAAFR) (JP 1-02) — Routes established below the coordinating altitude to facilitate the movement of Army aviation assets. Routes are normally located in the corps through brigade rear areas of operation and do not require approval by the airspace control authority. (See airspace control measures.) See FM 100-103. **3-5**

standing operating procedure (SOP) (JP 1-02, NATO) — A set of instructions covering those features of operations which lend themselves to a definite or standardized procedure without loss of effectiveness. The procedure is applicable unless ordered otherwise. See FM 101-5.

start point (SP) (NATO, Army) — A well-defined point on a route at which a movement of vehicles begins to be under the control of the commander of this movement. It is at this point that the column is formed by the successive passing, at an appointed time, of each of the elements composing the column. In addition to the principal start point of a column there may be secondary start points for its different elements. (See also release point (RP).) See FM 55-30. **3-26**

state of readiness (JP 1-02) — **state 1 (safe)** The state of a demolition target upon or within which the demolition charge has been placed and secured. The firing or initiating circuits have been installed, but not connected to the demolition charge. Detonators or initiators have not been connected nor installed. (JP 1-02, NATO) — **state 2 (armed)** The state of a demolition target in which the demolition charges are in place, the firing and priming circuits are installed and complete, ready for immediate firing. See FM 5-102.

status-of-forces agreement (SOFA) (JP 1-02) — An agreement which defines the legal position of a visiting military force deployed in the territory of a friendly state. Agreements delineating the status of visiting military forces may be bilateral or multilateral. Provisions pertaining to the status of visiting forces may

be set forth in a separate agreement, or they may form a part of a more comprehensive agreement. These provisions describe how the authorities of a visiting force may control members of that force and the amenability of the force or its members to the local law or to the authority of local officials. To the extent that agreements delineate matters affecting the relations between a military force and civilian authorities and population, they may be considered as civil affairs agreements. (See also stability and support operations (SASO).) See FM 100-20.

stay behind force (JP 1-02, NATO) — A force which is left in position to conduct a specified mission when the remainder of the force withdraws or retires from the area. See FMs 17-95 and 71-100.

stick (air transport) (JP 1-02) — A number of paratroopers who jump from one aperture or door of an aircraft during one run over a drop zone. See FM 90-26.

stowage plan (JP 1-02) — A completed stowage diagram showing what materiel has been loaded and its stowage location in each hold, between-deck compartment, or other space in a ship, including deck space. Each port of discharge is indicated by colors or other appropriate means. Deck and between-deck cargo normally is shown in perspective, while cargo stowed in the lower hold is shown in profile, except that vehicles usually are shown in perspective regardless of stowage.

straggler(JP 1-02, NATO) — Any personnel, vehicles, ships, or aircraft which, without apparent purpose or assigned mission, become separated from their unit, column or formation.

straggler control — Operations conducted to regulate friendly forces who have become separated from their commands by events on the battlefield.

strategic air transport operations (JP 1-02, NATO) — The carriage of passengers and cargo between theaters by means of: **a.** scheduled service; **b.** special flight; **c.** air logistic support; **d.** aeromedical evacuation. See FMs 8-10-6, 100-5, and 100-15.

strategic intelligence (JP 1-02) — Intelligence that is required for the formulation of military strategy, policy, and plans and operations at national and theater levels. (See also intelligence.) See FM 100-5.

strategic level of war (JP 1-02) — The level of war at which a nation, often as a member of a group of nations, determines national or multinational (alliance or coalition) strategic security objectives and guidance, and develops and uses national resources to accomplish these objectives. Activities at this level establish national and multinational military objectives; sequence initiatives; define limits and assess risks for the use of military and other instruments of national power; develop global plans or theater war plans to achieve these objectives; and provide military forces and other capabilities in accordance with strategic plans. (See also operational level of war and tactical level of war.) See FM 100-5.

strategic mobility (JP 1-02) — The capability to deploy and sustain military forces worldwide in support of national strategy.

strategic operating systems — The functions and subfunctions that describe the activities performed within a theater by unified, joint, or combined forces. The eight operating systems are theater force requirements and readiness, alliance and regional relations, theater strategic intelligence, theater strategic direction and integration, intra-theater strategic deployment and maneuver, theater strategic fires, theater strategic protection, and theater strategic sustainment.

OPERATIONAL TERMS AND GRAPHICS

strategic psychological activities (JP 1-02, NATO) — Planned psychological activities in peace and war which normally pursue objectives to gain the support and cooperation of friendly and neutral countries and to reduce the will and the capacity of hostile or potentially hostile countries to wage war.

strategy (JP 1-02) — The art and science of developing and using political, economic, psychological, and military forces as necessary during peace and war, to afford the maximum support to policies, in order to increase the probabilities and favorable consequences of victory and to lessen the chances of defeat.

striking force — A committed force organized to conduct the decisive attack in a mobile defense. It normally comprises the maximum combat power available to the commander at the time of the attack.

STRIKWARN — A message transmitted to give advance warning of a friendly nuclear attack to ensure friendly forces can protect themselves from the effects of the attack.

strong point (SP) (JP 1-02, NATO) — A key point in a defensive position, usually strongly fortified and heavily armed with automatic weapons, around which other positions are grouped for its protection. (Army) — A position requiring extensive engineer effort for obstacles and survivability positions and positioned to control or block an avenue of approach. Normally, command and control, aid stations, and critical supply stockpiles will be dug in with overhead protection. Trenches and other protective construction will be done to protect soldiers and weapons from damage during assault by mounted and dismounted forces. (See also battle position (BP) and mobile defense.) See FMs 1-111, 6-20, 7-20, 7-30, 17-95, 71-100, 71-123, 100-5, 100-15, 100-40, and 101-5. **3-9** **3-33**

subsequent operations phase — The phase of an airborne, air assault, or amphibious operation conducted after the assault phase. Operations in the objective area may consist of offense, defense, linkup, or withdrawal. (See also air movement, assault phase, and mounting phase.)

subsequent position — A planned and, to some extent, prepared location for defense or delay that is behind (away from the enemy) the primary positions initially occupied for a defense. See FMs 1-111, 6-20, 7-20, 7-30, 17-95, 71-100, 71-123, 100-15, 100-40, and 101-5.

subversion (JP 1-02) — Action designed to undermine the military, economic, psychological, or political strength or morale of a regime. (See also unconventional warfare (UW).) See FM 100-20.

successive positions — Defensive fighting positions located one after another on the battlefield. A force can conduct a delaying action or defense from successive positions. (See also defend and delaying operation.) See FMs 1-111, 6-20, 7-20, 7-30, 17-95, 71-100, 71-123, 100-15, 100-40, and 101-5.

supervised route (JP 1-02, NATO) — In road traffic, a roadway over which limited control is exercised by means of traffic control posts, traffic patrols, or both. Movement authorization is required for its use by a column of vehicles or a vehicle of exceptional size or weight. See FMs 55-10 and 55-30.

supplementary position — That location which provides the best sectors of fire and defensive terrain along an avenue of approach other than the primary avenue the enemy is expected to attack along, for example, a flank avenue of approach. (See also alternate position, battle position, position (BP), and successive positions.) See FMs 1-111, 6-20, 7-20, 7-30, 17-95, 71-100, 71-123, 100-15, 100-40, and 101-5.

supply control (JP 1-02) — The process by which an item of supply is controlled within the supply system, including requisitioning, receipt, storage, stock control, shipment, disposition, identification, and accounting.

supply discipline — Command responsibility to identify and redistribute excess materiel, observe senior commander's priorities, and ensure subordinates operate within the legal boundaries of the logistics system.

supply point (JP 1-02, NATO) — Any point where supplies are issued in detail. (Army) — A location where supplies, services, and materiel are located and issued. These locations are temporary and mobile, normally being occupied for up to 72 hours. **3-39**

supply point distribution — A method of distributing supplies to the receiving unit at a supply point, railhead, or truckhead. The unit then moves the supplies to its own area using its own transportation.

supply site — A location where supplies, services, and materiel are located or stored in a permanent or semipermanent facility.

support (JP 1-02) — **1.** The action of a force which aids, protects, complements, or sustains another force in accordance with a directive requiring such action. **2.** A unit which helps another unit in battle. Aviation, artillery, or naval gunfire may be used as a support for infantry. **3.** A part of any unit held back at the beginning of an attack as a reserve. **4.** An element of a command which assists, protects, or supplies other forces in combat. (See also common servicing, direct support (DS), and general support (GS).)

support area — A designated area in which combat service support elements and some staff elements locate to support a unit. (See also brigade support area (BSA) and division support area (DSA).) **3-39**

support by fire — A tactical task in which a maneuver element moves to a position on the battlefield where it can engage the enemy by direct fire to support a maneuvering force by either support by fire by overwatching or by establishing a base of fire. The maneuver element does not attempt to maneuver to capture enemy forces or terrain. (See also attack by fire and overwatch.) See FMs 1-111, 6-20, 7-20, 7-30, 17-95, 71-100, 71-123, 100-15, and 101-5. **3-18** **C-11**

support force — Those forces charged with providing intense direct overwatching fires to the assault and breaching forces or a force that supports a river crossing and other combat operations. (See also breach force.)

supporting arms (JP 1-02) — Air, sea, and land weapons of all types employed to support ground units.

supporting attack (JP 1-02, NATO) — An offensive operation carried out in conjunction with a main attack and designed to achieve one or more of the following: deceive the enemy; destroy or pin down enemy forces which could interfere with the main attack; control ground whose occupation by the enemy will hinder the main attack; or force the enemy to commit reserves prematurely or in an indecisive area. (See also main attack.) See FMs 1-111, 6-20, 7-20, 7-30, 17-95, 71-100, 71-123, 100-15, 100-40, and 101-5. **3-15, 3-16**

supporting distance — Distance between two units that can be traveled in time for one to come to the aid of the other. For small units, it is the distance between two units that can be covered effectively by their fires.

supporting effort — The unit, battle position, sector, zone, axis, avenue of approach, area of operations, theater of operations, and so forth, whose purpose supports the success of the main effort. The supporting effort, either directly or indirectly, creates a necessary condition for the main effort to succeed. The higher commander will use other operations, such as economy of force, deep operations, interdiction,

OPERATIONAL TERMS AND GRAPHICS

deception operations (feints and demonstrations), counterattacks, and supporting attacks as part of the supporting effort. (See also economy of force, main attack, main effort, and supporting attack. See FMs 1-111, 6-20, 7-20, 7-30, 17-95, 71-100, 71-123, 100-15, and 101-5.

supporting forces (JP 1-02) — Forces stationed in, or to be deployed to, an area of operations to provide support for the execution of an operation order. Combatant command (command authority) of supporting forces is not passed to the supported commander.

suppression (JP 1-02) — Temporary or transient degradation by an opposing force of the performance of a weapons system below the level needed to fulfill its mission objectives. (Army) — A tactical task to employ direct or indirect fires, electronic attack, or smoke on enemy personnel, weapons, or equipment to prevent or degrade enemy fires and observation of the friendly forces. See FMs 1-111, 6-20, 7-20, 7-30, 17-95, 71-100, 71-123, 100-15, 100-40, and 101-5.

suppression of enemy air defenses (SEAD) (JP 1-02) — That activity which neutralizes, destroys, or temporarily degrades surface-based enemy air defenses by destructive and/or disruptive means. (Army) — The Army has primary responsibility for suppressing ground-based enemy air defense weapons to the limits of observed fire. The United States Air Force (USAF) has responsibility from beyond the limits of observed fire out to the range limits of Army weapons systems; the Army, secondary responsibility. Even if the USAF can target or observe, the Army may still have to attack the target. Beyond the range limits of Army weapons, the USAF is responsible. (See also suppression.) See FM 6-series. (Army) — **campaign SEAD** — SEAD operations that are preplanned, theaterwide efforts conducted concurrently over an extended period against air defense systems normally located well behind enemy lines. **complementary SEAD** — SEAD operations that involve continuously seeking enemy air defense system targets to destroy them. **localized SEAD** — SEAD operations that support tactical air operations, Army aviation operations, reconnaissance, and the establishment of corridors for Air Force and Army assets.

surprise — One of the nine principles of war. The enemy is attacked at a time or place, or in a manner for which he is unprepared and which he did not expect. See FM 100-5.

surveillance (JP 1-02, NATO) — The systematic observation of aerospace, surface or subsurface areas, places, persons, or things, by visual, aural, electronic, photographic, or other means. (Army) — This includes the use of special NBC and air defense equipment. (See also sensor.)

survey — **1.** The act of determining a precise location with various instruments. **2.** The directed effort to determine the location and the nature of contamination within an area. See FMs 3-3 and 3-19. **3.** The element of an artillery unit which determines an exact location and marks it as a point of reference for laying in the artillery unit. See FMs 6-series and 7-90.

survivability — **1.** Includes all aspects of protecting personnel, weapons, and supplies while simultaneously deceiving the enemy. **2.** Encompasses planning and locating position sites, designing adequate overhead cover, analyzing terrain conditions and construction materials, selecting excavation methods, and countering the effects of direct and indirect fire weapons. See FM 5-103. **3-33**

survivability operations — The development and construction of protective positions such as earth berms, dug-in positions, overhead protection, and countersurveillance means to reduce the effectiveness of enemy weapon systems. See FM 5-103.

survival, evasion, resistance, and escape (SERE) — Training and actions taken by military members to assist them in surviving in hostile environments, resisting enemy activities, escaping enemy forces, and evading enemy forces until the individual or unit can be reunited with friendly forces. See FM 1-111.

suspect (JP 1-02) — In counterdrug operations, a track of interest where correlating information actually ties the track of interest to alleged illegal drug operations. See FM 100-20.

sustained rate of fire (JP 1-02, NATO) — Actual rate of fire that a weapon can continue to deliver for an indefinite length of time without seriously overheating. (Army) — Or without doing other mechanical damage to the weapon or weapon system. (See also maximum rate of fire.) See FMs 6-series, 7-90, 7-91, 17-12, and 23-1.

sustainment (JP 1-02) — The provision of personnel, logistic, and other support required to maintain and prolong operations or combat until successful accomplishment or revision of the mission or of the national objective.

sweep jamming (JP 1-02, NATO) — A narrow band of jamming that is swept back and forth over a relatively wide operating band of frequencies.

synchronization (JP 1-02) — **1.** The arrangement of military actions in time, space, and purpose to produce maximum relative combat power at a decisive place and time. **2.** In the intelligence context, application of intelligence sources and methods in concert with the operational plan. See FMs 1-111, 6-20, 7-20, 7-30, 17-95, 71-100, 71-123, 100-5, 100-15, 100-40, and 101-5.

synchronization matrix — A format for the staff to record the results of wargaming and synchronize the course of action (COA) across time, space, and purpose in relation to the enemy's most likely COA. The staff can readily translate a synchronization matrix into a graphic decision-making product such as a decision support matrix. Each battlefield operating system can develop its own synchronization matrix for more detail on specific tasks. See FM 101-5.

T

tactical air control party (TACP) (JP 1-02, NATO) — A subordinate operational component of a tactical air control system designed to provide air liaison to land forces and for the control of aircraft.

tactical air liaison officer (TALO) (Army) — An Air Force officer who works at the division or higher rear command post G4 section and facilitates the coordination of cargo aircraft. He maintains information on runway availability, cargo handling capability, and the location of brigade medical treatment facilities and landing areas. See FMs 71-100-1/2/3 and 100-15.

tactical air operation (JP 1-02) — An air operation involving the employment of air power in coordination with ground or naval forces to: **a.** gain and maintain air superiority; **b.** prevent movement of enemy forces into and within the objective area and to seek out and destroy these forces and their supporting installations; and **c.** join with ground or naval forces in operations within the objective area, in order to assist directly in attainment of their immediate objective. (See also air interdiction (AI), allocation, apportionment, close air support (CAS), and counterair.)

tactical air reconnaissance — See air reconnaissance.

tactical ballistic missile (TBM) predicted ground impact point (PGIP) — An elliptical area that indicates where a TBM most likely will strike the ground. This area varies in size based on the known or suspected accuracy of the TBM if it functions normally. (See also theater missile defense (TMD).) See FM 44-100.

OPERATIONAL TERMS AND GRAPHICS

tactical combat force (TCF) (JP 1-02) — A combat unit, with appropriate combat support and combat service support assets, that is assigned the mission of defeating Level III threats. (See also rear area response forces.) See FMs 1-111, 6-20, 7-20, 7-30, 17-95, 71-100, 71-123, 100-15, and 101-5.

tactical command post (TAC CP) — The forward echelon of a headquarters. The TAC CP consists of representatives from G/S2, G/S3, fire support, tactical air control party, air defense artillery engineers, and combat service support liaison (G/S1, G/S4) elements. It is located well forward on the battlefield so that the commander is near subordinate commanders and can directly influence operations. At division level, the TAC CP is normally located within FM radio range of the committed brigades. (See also command post (CP).) See FM 101-5. **A-3**

tactical control (TACON) (JP 1-02) — Command authority over assigned or attached forces or commands, or military capability or forces made available for tasking, that is limited to the detailed and, usually, local direction and control of movements or maneuvers necessary to accomplish missions or tasks assigned. Tactical control is inherent in operational control. Tactical control may be delegated to, and exercised at any level at or below the level of combatant command. (Army) — Tactical control allows commanders below combatant command level to apply force and direct the tactical use of logistics assets but does not provide authority to change organizational structure or direct administrative and logistical support. See FMs 1-111, 31-20, 71-100, 100-15, and 101-5.

tactical intelligence (JP 1-02) — Intelligence that is required for planning and conducting tactical operations. (See also intelligence and combat intelligence.) See FM 34-1, 34-2, 34-3, and 34-130.

tactical level of war (JP 1-02) — The level of war at which battles and engagements are planned and executed to accomplish military objectives assigned to tactical units or task forces. Activities at this level focus on the ordered arrangement and maneuver of combat elements in relation to each other and to the enemy to achieve combat objectives.

tactical minefield (JP 1-02, NATO) — A minefield which is part of a formation obstacle plan and is laid to delay, channel, or break up an enemy advance (Army) — Minefield employed to directly attack enemy maneuver and to give the defending element a positional advantage over the attacker. See FM 20-32.

3-30, 3-31

tactical movement — A movement or maneuver to contact with the enemy or during which contact is anticipated. In a tactical movement, elements are organized to facilitate combat. (See also administrative movement.) See FM 100-15.

tactical obstacles (JP 1-02) — Those obstacles employed to disrupt enemy formations, to turn them into a desired area, to fix them in position under direct and indirect fires, and to block enemy penetrations. (See also obstacle.)

tactical operations center (TOC) (JP 1-02) — A physical groupment of those elements of an Army general and special staff concerned with the current tactical operations and the tactical support thereof. (See also command post (CP).) **A-2**

tactical road march — A rapid movement used to relocate units within a combat zone in order to prepare for combat operations. Although contact with enemy ground forces is not anticipated, security against air attack, enemy special forces, and sympathizers is maintained and the unit is prepared to take immediate action against an enemy threat. (See also march column, march serial, and march unit.) See FMs 7-20, 7-30, 17-95, 55-30, 71-100, 71-123, 100-15, 100-40, and 101-5.

tactical task — The specific activity to be performed by the unit while conducting a form of tactical operation or a choice of maneuver. It is the minimum essential effects to accomplish the purpose. (See also mission statement and operation order (OPORD).) See FMs 1-111, 6-20, 7-20, 7-30, 17-95, 71-100, 71-123, 100-5, 100-15, and 101-5.

tactics (JP 1-02) — **1.** The employment of units in combat. **2.** The ordered arrangement and maneuver of units in relation to each other and/or to the enemy in order to use their full potentialities. (Army) — **tactics, techniques, and procedures (TTP)** — **1. Tactics** — the art and science of employing available means to win battles and engagements. **2. Techniques** — the methods used by troops and/or commanders to perform assigned missions and functions, specifically, the method of employing equipment and personnel. **3. Procedures** — the standard and detailed courses of action that describe how to perform a task. See FMs 1-111, 6-20, 7-20, 7-30, 17-95, 71-100, 71-123, 100-15, 100-40, and 101-5.

tailor — To task-organize forces for the accomplishment of a specific mission.

tanker airlift control element (TALCE) (JP 1-02) — A mobile command and control organization deployed to support strategic and theater air mobility operations at fixed, en route, and deployed locations where air mobility operational support is nonexistent or insufficient. The Tanker Airlift Control Element provides on-site management of air mobility airfield operations to include command and control, communications, aerial port services, maintenance, security, transportation, weather, intelligence, and other support functions, as necessary. The Tanker Airlift Control Element is composed of mission support elements from various units and deploys in support of peacetime, contingency, and emergency relief operations on both planned and "no notice" basis. See FMs 55-12, 71-100, 71-100-2, 71-100-3, 90-26, and 100-15.

target (JP 1-02) — **1.** A geographical area, complex, or installation planned for capture or destruction by military forces. **2.** In intelligence usage, a country, area, installation, agency, or person against which intelligence operations are directed. **3.** An area designated and numbered for future firing. **3-22** **3-24** **4.** In gunfire support usage, an impact burst which hits the target. (NATO) In radar, any discrete object which reflects or retransmits energy back to the radar equipment, or the object of a radar search or surveillance. See FM 44-100. (Army) — An object, vehicle, individual, and so forth, which is the aiming point of any weapon or weapon system. See FMs 6-series, 7-90, 7-91, 17-12, and 23-1.

target acquisition (JP 1-02, NATO) — The detection, identification, and location of a target in sufficient detail to permit the effective employment of weapons. (See also target analysis.) See FMs 6-series, 7-90, 7-91, 17-12, and 23-1.

target analysis (JP 1-02, NATO) — An examination of potential targets to determine military importance, priority of attack, and weapons required to obtain a desired level of damage or casualties. (See also target acquisition.)

target array (JP 1-02) — A graphic representation of enemy forces, personnel, and facilities in a specific situation, accompanied by a target analysis.

target box — Areas designated on identifiable terrain in which enemy targets are expected to appear and against which air support will be employed. See FMs 6-series and 7-90.

target concentration (JP 1-02, NATO) — A grouping of geographically proximate targets. (See also target and group of targets.)

OPERATIONAL TERMS AND GRAPHICS

targeted area of interest (TAI) — The geographical area or point along a mobility corridor where successful interdiction will cause the enemy to either abandon a particular course of action or require him to use specialized engineer support to continue, where he can be acquired and engaged by friendly forces. Not all TAIs will form part of the friendly course of action; only TAIs associated with high-payoff targets are of interest to the staff. These are identified during staff planning and wargaming. TAIs differ from engagement areas in degree. Engagement areas plan for the use of all available weapons; TAIs might be engaged by a single weapon. See FM 34-130. **3-20**

targeting (JP 1-02) — **1.** The process of selecting targets and matching the appropriate response to them, taking account of operational requirements and capabilities. **2.** The analysis of enemy situations relative to the commander's mission, objectives, and capabilities at the commander's disposal, to identify and nominate specific vulnerabilities that, if exploited, will accomplish the commander's purpose through delaying, disrupting, disabling, or destroying enemy forces or resources critical to the enemy. See FM 6-20-10.

target list (JP 1-02) — The listing of targets maintained and promulgated by the senior echelon of command; it contains those targets that are to be engaged by supporting arms, as distinguished from a "list of targets" that may be maintained by any echelon as confirmed, suspected, or possible targets for informational and planning purposes. See FM 6-series and 7-90.

target of opportunity (JP 1-02) — **1.** A target visible to a surface or air sensor or observer which is within range of available weapons and against which fire has not been scheduled or requested. **2. nuclear** — A nuclear target observed or detected after an operation begins that has not been previously considered, analyzed, or planned for a nuclear strike. Generally fleeting in nature, it should be attacked as soon as possible within the time limitations imposed for coordination and warning of friendly troops and aircraft. See FMs 6-series, 7-90, 7-91, 17-12, and 23-1.

target-oriented method — A method of nuclear analysis used when detailed target information is available. It gives the best estimate of the effects that the weapon will probably have on the target. See JPs 3-12.2 and 3-12.3.

target overlay (JP 1-02, NATO) — A transparent sheet which, when superimposed on a particular chart, map, drawing, tracing or other representation, depicts target locations and designations. The target overlay may also show boundaries between maneuver elements, objectives, and friendly forward dispositions. See FMs 6-series and 101-5.

target reference point (TRP) — An easily recognizable point on the ground (either natural or man-made) used to initiate, distribute, and control fires. TRPs are designated by maneuver leaders from platoon through battalion to define battalion, company, platoon, section, squad, or individual sectors of fire and observation usually within an engagement area. TRPs can also designate the center of an area where the commander plans to distribute or converge the fires of all his weapons rapidly. TRPs are designated using the standard target symbol and numbers issued by maneuver commanders. Once approved by the battalion fire support officer, TRPs can be designated as indirect fire targets using the standard target symbol with letters and numbers issued by the fire support officer. (See also engagement area (EA), principal direction of fire (PDF), and sector of fire.) See FMs 6-series, 7-7, 7-8, 7-10, 7-20, 7-90, 7-91, 17-12, 17-15, 17-9 and 23-1. **3-9**

target signature (JP 1-02, NATO) — **1.** The characteristic pattern of a target displayed by detection and identification equipment. **2.** In naval mine warfare, the variation in the influence field produced by the passage of a ship or sweep.

task force (TF) (JP 1-02, NATO) — **1.** A temporary grouping of units, under one commander, formed for the purpose of carrying out a specific operation or mission. **2.** Semipermanent organization of units, under one commander, formed for the purpose of carrying out a continuing specific task. **3.** (Army) — A battalion-sized unit of the combat arms consisting of a battalion control headquarters, with at least one of its major organic subordinate elements (a company), and the attachment of at least one company-sized element of another combat or combat support arm. (See also task organization.) A component of a fleet organized by the commander of a task fleet or higher authority for the accomplishment of a specific task or tasks. See FMs 1-111, 6-20, 7-20, 7-30, 17-95, 71-100, 71-123, 100-15, 100-40, and 101-5.

task organization (JP 1-02) — **1.** In the Navy, an organization which assigns to responsible commanders the means with which to accomplish their assigned tasks in any planned action. **2.** An organization table pertaining to a specific naval directive. (Army) — A temporary grouping of forces designed to accomplish a particular mission. It is the process of allocating available assets to subordinate commanders and (establishing) determining their command and support relationships. See FMs 1-111, 6-20, 7-20, 7-30, 17-95, 71-100, 71-123, 100-15, 100-40, and 101-5.

technical control (TECHCON) — The authority a controlling element has to control all technical aspects of other unit operations.

technical intelligence (TECHINT) (JP 1-02) — Intelligence derived from exploitation of foreign materiel, produced for strategic, operational, and tactical level commanders. Technical intelligence begins when an individual service member finds something new on the battlefield and takes the proper steps to report it. The item is then exploited at succeeding higher levels until a countermeasure is produced to neutralize the adversary's technological advantage. (See also intelligence, and scientific and technical intelligence.)

tempo — The rate of military action; controlling or altering that rate is a necessary means to initiative. All military operations alternate between action and pauses as opposing forces battle one another and fight friction to mount and execute operations at the time and place of their choosing. See FM 100-5.

terrain analysis (JP 1-02, NATO) — The collection, analysis, evaluation, and interpretation of geographic information on the natural and manmade features of the terrain, combined with other relevant factors, to predict the effect of the terrain on military operations. See FMs 34-3 and 34-130.

terrain flight (JP 1-02, NATO) — Flight close to the Earth's surface during which airspeed, height, and/or altitude are adapted to the contours and cover of the ground in order to avoid enemy detection and fire. See FM 1-111.

terrain following — Terrain flying that includes low-level, contour, and nap-of-the-earth flight techniques. See FMs 1-111 and 100-103.

terrain management — **1.** The process of allocating terrain by establishing areas of operation, designating assembly areas, and specifying locations for units and activities to deconflict activities that might interfere with each other, for example, ensuring artillery firing units are not placed within air corridors. **2.** In rear operations, the process includes grouping units together to form bases, and designating a base cluster as necessary. See FMs 1-111, 6-20, 7-3, 7-30, 71-100, and 100-15.

terrain reinforcement — The development of terrain using obstacles to degrade enemy mobility or to enhance friendly survivability through the construction of fighting positions and cover. (See also countermobility operations and survivability operations.)

OPERATIONAL TERMS AND GRAPHICS

terrorism (JP 1-02) — The calculated use of violence or threat of violence to inculcate fear; intended to coerce or to intimidate governments or societies in the pursuit of goals that are generally political, religious, or ideological. (See also antiterrorism (AT) and counterterrorism (CT).) See FM 100-20.

terrorist (JP 1-02) — An individual who uses violence, terror, and intimidation to achieve a result. See FM 100-20.

terrorist threat condition (THREATCON) (JP 1-02) — A Chairman of the Joint Chiefs of Staff-approved program standardizing the Military Services' identification of and recommended responses to terrorist threats against US personnel and facilities. This program facilitates inter-Service coordination and support for antiterrorism activities. There are four THREATCONs above normal: **a. THREATCON ALPHA** — This condition applies when there is a general threat of possible terrorist activity against personnel and facilities, the nature and extent of which are unpredictable, and circumstances do not justify full implementation of THREATCON BRAVO measures. However, it may be necessary to implement certain measures from higher THREATCONs resulting from intelligence received or as a deterrent. The measures in this THREATCON must be capable of being maintained indefinitely. **b. THREATCON BRAVO** — This condition applies when an increased and more predictable threat of terrorist activity exists. The measures in this THREATCON must be capable of being maintained for weeks without causing undue hardship, affecting operational capability, and aggravating relations with local authorities. **c. THREATCON CHARLIE** — This condition applies when an incident occurs or intelligence is received indicating some form of terrorist action against personnel and facilities is imminent. Implementation of measures in this THREATCON for more than a short period probably will create hardship and affect the peacetime activities of the unit and its personnel. **d. THREATCON DELTA** — This condition applies in the immediate area where a terrorist attack has occurred or when intelligence has been received that terrorist action against a specific location or person is likely. Normally, this THREATCON is declared as a localized condition. (See also antiterrorism (AT).) See FM 100-20.

theater(JP 1-02) — The geographical area outside the continental United States for which a commander of a combatant command has been assigned responsibility. See FMs 100-5 and 100-7.

theater airlift (intratheater airlift) (Army) — The movement of personnel and materiel by aircraft within a theater of operations that provides air movement and delivery of combat troops and supplies directly into objective areas through airlanding, extraction, airdrop, or other delivery techniques; the use of air transport in direct support of airborne assault, carriage of air transported forces, tactical air supply, evacuation of casualties from forward airfields, and special operations. See FMs 8-10-6, 100-5, and 100-17.

theater missile (TM) (JP 1-02) — A missile, which may be a ballistic missile, a cruise missile, or an air-to-surface missile (not including short-range, non-nuclear, direct-fire missiles, bombs, or rockets such as Maverick or wire-guided missiles), whose target is within a given theater of operation. See FM 44-100 and JP 3-01.5.

theater missile defense (TMD) — Applies to the identification, integration, and employment of forces supported by other theater and national capabilities, to detect, identify, locate, track, minimize the effects of, or destroy enemy theater missiles (TMs). This includes the destruction of TMs on the ground and in flight, their ground-based launchers and supporting infrastructure; TM-capable ships and vessels in port or at sea; and enemy aircraft armed with air-to surface missiles. TMD comprises four pillars necessary for a complete TM defense: passive defense, active defense, attack operations, and C⁴I measures. See FM 44-100 and JP 3-01.5. **4-11**

theater missile defense system — Applies to a system or systems with applicable capabilities that may be used to support passive defense measures, active defense measures, attack operations capabilities, and the command, control, communications, computers, and intelligence and countermeasures required to counter the missile threat. See FM 44-100.

thermal crossover (JP 1-02) — The natural phenomenon which normally occurs twice daily when temperature conditions are such that there is a loss of contrast between two adjacent objects on infrared imagery. See FMs 7-91, 17-12, and 23-1.

thermal radiation (JP 1-02, NATO) — **1.** The heat and light produced by nuclear explosion. (DOD)
2. Electromagnetic radiations emitted from a heat or light source as a consequence of its temperature; it consists essentially of ultraviolet, visible, and infrared radiations. See JPs 3-12.2 and 3-12.3.

thorough decontamination (JP 1-02, NATO) — Decontamination carried out by a unit, with or without external support, to reduce contamination on personnel, equipment, materiel and/or working areas to the lowest possible levels, to permit the partial or total removal of individual protective equipment, and to maintain operations with minimum degradation. This may include terrain decontamination beyond the scope of operational decontamination. (See also decontamination, immediate decontamination, and operational decontamination.) See FM 3-5.

throughput (JP 1-02) — The average quantity of cargo and passengers that can pass through a port on a daily basis from arrival at the port to loading onto a ship or plane, or from the discharge from a ship or plane to the exit (clearance) from the port complex. Throughput is usually expressed in measurement tons, short tons, or passengers. Reception and storage limitation may affect final throughput. See FM 100-10.

throughput distribution — The bypassing of one or more intermediate supply echelons in the supply system to avoid multiple handling. See FM 100-10.

time of attack (JP 1-02) — The hour at which the attack is to be launched. If a line of departure is prescribed, it is the hour at which the line is to be crossed by the leading elements of the attack. (See also H-hour.) See FMs 1-111, 6-20, 7-20, 7-30, 17-95, 71-100, 71-123, 100-15, 100-40, and 101-5.

time of flight (JP 1-02, NATO) — In artillery and naval gunfire support, the time in seconds from the instant a weapon is fired, launched, or released from the delivery vehicle or weapons system to the instant it strikes or detonates. See FMs 6-series and 7-90.

time-phased force and deployment data (TPFDD) (JP 1-02) — The Joint Operation Planning and Execution System data base portion of an operation plan; it contains time-phased force data, nonunit-related cargo and personnel data, and movement data for the operation plan, including: **a.** In-place units. **b.** Units to be deployed to support the operation plan with a priority indicating the desired sequence for their arrival at the port of debarkation. **c.** Routing of forces to be deployed. **d.** Movement data associated with deploying forces. **e.** Estimates of nonunit-related cargo and personnel movements to be conducted concurrently with the deployment of forces. **f.** Estimate of transportation requirements that must be fulfilled by common-user lift resources, as well as those requirements that can be fulfilled by assigned or attached transportation resources. See JP 5-0.

time-phased force and deployment list (TPFDL) (JP 1-02) — Appendix 1 to Annex A of the operation plan. It identifies types and/or actual units required to support the operation plan and indicates origin and ports of debarkation or ocean area. It may also be generated as a computer listing from the time-phased force and deployment data.

OPERATIONAL TERMS AND GRAPHICS

time on target (TOT) (JP 1-02) — **1.** Time at which aircraft are scheduled to attack/photograph the target. **2.** The actual time at which aircraft attack/photograph the target. **3.** The time at which a nuclear detonation is planned at a specified desired ground zero. See FM 6-series.

time zone — A geographical area having the exact same time (clockwise). These areas are designated from east to west from ZULU time or Greenwich Mean Time and expressed by a letter of the alphabet.

tolerance dose (JP 1-02) — The amount of radiation which may be received by an individual within a specified period with negligible results.

topographical crest — Highest point of a hill, ridge, or mountain. (See also military crest.) See FM 21-26.

topographic map (JP 1-02) — A map which presents the vertical position of features in measurable form as well as their horizontal positions. See FM 21-26.

total asset visibility (TAV) — The ability to identify the location of equipment, supplies, or personnel during in-processing and while in transit or in storage. See FM 55-12.

total mobilization. See mobilization.

toxin agent (JP 1-02) — A poison formed as a specific secretion product in the metabolism of a vegetable or animal organism as distinguished from inorganic poisons. Such poisons can also be manufactured by synthetic processes. See FM 3-9 and 3-100.

track (JP 1-02) — **1.** A series of related contacts displayed on a plotting board. **2.** To display or record the successive positions of a moving object. **3.** To lock onto a point of radiation and obtain guidance therefrom. **4.** To keep a gun properly aimed, or to point continuously a target-locating instrument at a moving target. **5.** The actual path of an aircraft above, or a ship on, the surface of the Earth. The course is the path that is planned; the track is the path that is actually taken. **6.** One of the two endless belts on which a full-track or half-track vehicle runs. **7.** A metal part forming a path for a moving object, e.g., the track around the inside of a vehicle for moving a mounted machine gun.

tracking (JP 1-02, NATO) — **1.** Precise and continuous position-finding of targets by radar, optical, or other means. (DOD) **2.** In air intercept, a code meaning, "By my evaluation, target is steering true course indicated."

trafficability (JP 1-02, NATO) — Capability of terrain to bear traffic. It refers to the extent to which the terrain will permit continued movement of any and/or all types of traffic. See FMs 5-36, 34-3, and 34-130.

traffic control post (TCP) — A place at which traffic is controlled either by military police or by mechanical means. See FMs 17-95, 19-1, 55-10, 55-30, 71-100, 71-123, 100-15, and 100-40. **3-40**

trailer transfer point — A location where trailers are transferred from one carrier to another while *en route*. (See also logistics release point (LRP).) See FM 55-30. **3-40**

trail party — The last march unit in a march serial, usually consisting of priority maintenance and recovery vehicles. See also unit maintenance collection point (UMCP). See FM 63-2.

train (Army) — **1.** A service force or group of service elements which provides logistic support, that is, the vehicles and operating personnel which furnish supply, evacuation, and maintenance services to a land

unit. **2.** Bombs dropped in short intervals or sequence. (See also unit trains, combat trains, and field trains.) See FMs 17-95 and 71-123.

traveling — A movement technique used when speed is necessary and contact with enemy forces is not likely. All elements of the unit move simultaneously with the unit leader located where he can best control his unit. (See also movement technique.) See FM 7-7, 7-8, 7-10, 17-95, and 17-98.

traveling overwatch — A movement technique used when contact with enemy forces is possible. The lead element and trailing element are separated by a short distance which varies with the terrain. The trailing element moves at variable speeds and may pause for short periods to overwatch the lead element. It keys its movement to terrain and the lead element. The trailing element overwatches at such a distance that should the enemy engage the lead element, it will not prevent the trailing element from firing or moving to support the lead element. (See also movement technique.) See FM 7-7, 7-8, 7-10, 17-95, and 17-98.

traverse (JP 1-02, NATO) — 1. To turn a weapon to the right or left on its mount. 2. A method of surveying in which lengths and directions of lines between points on the earth are obtained by or from field measurements, and used in determining positions of the points. (Army) — To move across terrain. See FMs 7-91, 17-12, and 23-1.

triage (JP 1-02, NATO) — The evaluation and classification of casualties for purposes of treatment and evacuation. It consists of the immediate sorting of patients according to type and seriousness of injury, and likelihood of survival, and the establishment of priority for treatment and evacuation to assure medical care of the greatest benefit to the largest number. See FM 8-series.

trigger — **1.** Event or time-oriented criteria used to initiate planned actions directed toward achieving surprise and inflicting maximum destruction on the enemy. **2.** A designated point or points (selected along identifiable terrain) in an engagement area used to mass fires at a predetermined range.

troop safety (nuclear) (JP 1-02) — An element which defines a distance from the proposed burst location beyond which personnel meeting the criteria described under degree of risk will be safe to the degree prescribed. (Army) — It is expressed as a combination of a degree of risk and vulnerability category. (See also emergency risk (nuclear), negligible risk (nuclear), unwarned exposed, and warned protected.) See FM 100-30, JPs 3-12.2, and 3-12.3.

true azimuth — Direction measured as an angle to the east of the north star (Polaris). (See also azimuth.) See FM 21-26.

true north (JP 1-02, NATO) — The direction from an observer's position to the geographic North Pole. The north direction of any geographic meridian. See FM 21-26.

turn — A tactical obstacle effect that integrates fire planning and obstacle effort to divert an enemy formation off one avenue of approach to an adjacent avenue of approach, or into an engagement area. See FM 90-7. **3-31**

turnaround (JP 1-02, NATO) — The length of time between arriving at a point and being ready to depart from that point. It is used in this sense for the loading, unloading, refueling and rearming, where appropriate, of vehicles, aircraft, and ships. See FMs 1-111 and 55-30.

turning movement (JP 1-02, NATO) — A variation of the envelopment in which the attacking force passes around or over the enemy's principal defensive positions to secure objectives deep in the enemy's rear to

OPERATIONAL TERMS AND GRAPHICS

force the enemy to abandon his position or divert major forces to meet the threat. (See also choices of maneuver.) See FMs 100-5 and 100-15.

turret-down — Fighting position in which the entire vehicle is behind cover, but the commander can still observe to the front from the turret hatch or cupola. (See also hide and hull down.) See FMs 7-8, 7-91, 17-12, and 23-1.

twilight — The period of incomplete darkness following sunset and preceding sunrise. Twilight is designated as civil, nautical, or astronomical, as the darker limit occurs when the center of the sun is 6, 12, or 18 degrees, respectively, below the celestial horizon. (See also begin morning nautical twilight (BMNT).) See FM 34-130.

type of operation — A broad category of tactical activities, each with specific doctrinal tenets. Reconnaissance, security, entry operations, offensive operations, defensive operations, retrograde operations, troop movement, and specialized operations are specific types of operations. (See also form of tactical operations, choices of maneuver, and tactical task.) See FM 100-40.

U

uncertain environment. *See* operational environment.

uncommitted force — A force that is not in contact with an enemy and is not already assigned a specific mission or course of action which would preclude its use elsewhere.

unconventional warfare (UW) (JP 1-02) — A broad spectrum of military and paramilitary operations, normally of long duration, predominantly conducted by indigenous or surrogate forces who are organized, trained, equipped, supported, and directed in varying degrees by an external source. It includes guerrilla warfare and other direct offensive, low visibility, covert, or clandestine operations, as well as the indirect activities of subversion, sabotage, intelligence activities, and evasion and escape. (Army) — A broad spectrum of military and paramilitary operations conducted in enemy-held, enemy-controlled, or politically sensitive territory. UW includes guerrilla warfare, evasion and escape, subversion, sabotage, direct action missions, and other operations of a low-visibility, covert, or clandestine nature. These interrelated aspects of UW may be prosecuted singly or collectively by predominantly indigenous personnel, usually supported and directed in varying degrees by an external source during all conditions of war or peace. (See military operations other than war (MOOTW).) See FM 100-20.

underground— A covert unconventional warfare organization established to operate in areas denied to the guerrilla forces or conduct operations not suitable for guerrilla forces.

unexploded explosive ordnance (UXO) (JP 1-02, NATO) — Explosive ordnance which has been primed, fused, armed, or otherwise prepared for action, and which has been fired, dropped, launched, projected, or placed in such a manner as to constitute a hazard to operations, installations, personnel, or material, and remains unexploded either by malfunction or design or for any other cause. **3-33**

unified command (JP 1-02) — A command with a broad continuing mission under a single commander and composed of significant assigned components of two or more Military Departments, and which is established and so designated by the President, through the Secretary of Defense with the advice and assistance of the Chairman of the Joint Chiefs of Staff. Also called unified combatant command. See FM 100-5 and JP 5-0.

unit(JP 1-02, NATO) — **1.** Any military element whose structure is prescribed by competent authority, such as a table of organization and equipment; specifically, part of an organization. **2.** An organization title of a subdivision of a group in a task force. **3.** A standard or basic quantity into which an item of supply is divided, issued, or used. In this meaning, also called unit of issue. **4.** With regard to reserve components of the Armed Forces, denotes a Selected Reserve unit organized, equipped, and trained for mobilization to serve on active duty as a unit or to augment or be augmented by another unit. Headquarters and support functions without wartime missions are not considered units. (Army) — This first level of command (company, troop, or battery) upon which all other higher formations and organizations are built. (See also organization.)

unit distribution — A method of distributing supplies by which the receiving unit is issued supplies in its own area with transportation furnished by the issuing agency.

United Nations Protection Force (UNPROFOR) — A tailored, temporary force, comprised of joint and/or multinational forces or agencies under the command of the United Nations Secretary-General, that monitors or verifies compliance with United Nations Resolutions by various parties or ensures humanitarian care is provided to noncombatants. These forces are equipped with light defensive weapons and are authorized to use force only for self-defense. (See also implementation force (IFOR).) See FMs 100-20 and 100-23.

unit maintenance collection point (UMCP) — A location or a series of locations, operated by a battalion maintenance platoon, that is the nearest point to the combat unit to which equipment can be recovered, and where limited parts are available, and some repairs can be performed. See FM 72-1. **3-40**

unit trains — Combat service support personnel and equipment organic or attached to a force that provides support such as supply, evacuation, and maintenance services. Unit trains, whether or not echeloned, are under unit control and no portion of them is released to the control of a higher headquarters. Trains are normally echeloned into combat and field trains. (See also combat trains and field trains.) **4-23**

unity of command — One of the nine principles of war. All forces operate under one responsible commander who possesses requisite authority to direct forces in pursuit of a common unified purpose. (See also maneuver, offensive, objective, surprise, economy of force, mass, security, and simplicity.) See FM 100-5.

unity of effort — Coordination and cooperation among all forces, not necessarily part of the same command structure toward a commonly recognized objective. See FM 100-5.

Universal Time (ZULU) (JP 1-02) — A measure of time that conforms, within a close approximation, to the mean diurnal rotation of the Earth and serves as the basis of civil timekeeping. Universal Time (UTI) is determined from observations of the stars, radio sources, and also from ranging observations of the Moon and artificial Earth satellites. The scale determined directly from such observations is designated Universal Time Observed (UTO); it is slightly dependent on the place of observation. When UTO is corrected for the shift in longitude of the observing station caused by polar motion, the time scale UT1 is obtained. When an accuracy better than one second is not required, Universal Time can be used to mean Coordinated Universal Time (UTC). Formerly called Greenwich Mean Time. (See also ZULU time.) See FM 101-5.

universal transverse mercator grid (JP 1-02, NATO) — A grid coordinate system based on the transverse mercator projection, applied to maps of the Earth's surface extending to 84 degrees N and 80 degrees S latitudes. See FM 21-26.

OPERATIONAL TERMS AND GRAPHICS

unknown (JP 1-02) — **1.** A code meaning information not available. **2.** An unidentified target. (Army) — An aircraft or ship which has not been determined to be hostile, friendly, or neutral using identification friend or foe (IFF) and other techniques, but which must be tracked by air defense or naval engagement systems.

unobserved fire (JP 1-02, NATO) — Fire for which the points of impact or burst are not observed. See FM 6-series, 7-90, 7-91, 17-12, and 23-1.

unwarned exposed (JP 1-02, NATO) — The vulnerability of friendly forces to nuclear weapon effects. In this condition, personnel are assumed to be standing in the open at burst time, but have dropped to a prone position by the time the blast wave arrives. They are expected to have areas of bare skin exposed to direct thermal radiation, and some personnel may suffer dazzle. (See also warned exposed and warned protected.) See FM 100-30, JPs 3-12.2, and 3-12.3.

up (JP 1-02, NATO) — In artillery and naval gunfire support: **1.** A term used in a call for fire to indicate that the target is higher in altitude than the point which has been used as a reference point for the target location. **2.** A correction used by an observer or a spotter in time fire to indicate that an increase in height of burst is desired. (Army) — Indirect fire, a term used to move the point of aim higher than the previous point of aim, usually expressed in mils. See FMs 6-series, 7-90, 7-91, 17-12, and 23-1.

V

vaccine — A preparation of killed or attenuated infective or toxic agent used as an inoculation to produce active artificial immunity. See FM 3-9.

V-agents — Persistent, highly toxic nerve agents absorbed primarily through the skin. See FM 3-9.

vector — **1.** A carrier, especially the animal or intermediate host, that carries a pathogen from one host to another. See FM 3-9. **2.** An angle of direction expressed in degrees or mils to a target or a specified point.

vee formation — A unit formation with subordinate elements arranged in a V formation with the point facing away from the templated enemy. This formation is hard to reorient and difficult to control in heavily wooded areas but provides good firepower to the front and flanks. (See also formation, movement formation, and wedge formation.) See FMs 7-7, 7-8, and 7-20.

vehicle distance (JP 1-02, NATO) — The clearance between vehicles in a column which is measured from the rear of one vehicle to the front of the following vehicle. (See also march column, march serial, and march unit.) See FMs 55-10, 55-30, and 101-5.

vehicle washdown — Technique used for flushing contamination off equipment surfaces to limit the spreading and transferring of contamination. Along with mission-oriented protective posture (MOPP) gear exchange, it is part of decontamination operations. See FM 3-5.

versatility — The ability of units to meet diverse mission requirements and for commanders to shift focus, tailor forces, and move from one form or type of operation to another rapidly and efficiently. It is also the ability to be multifunctional and to operate across the full range of military operations. See FM 100-5.

vertical envelopment (JP 1-02) — A tactical maneuver in which troops, either air-dropped or air-landed, attack the rear and flanks of a force, in effect cutting off or encircling the force. (See also air assault and choices of maneuver.)

vesicant— chemical agent that acts on the eyes, lungs, and skin, capable of producing blisters. See FM 3-9.

visual flight rules (VFR) — A meteorological condition that allows pilots to control aircraft orientation and attitude using visual references (the ground and the natural horizon). When weather conditions are good enough to allow pilots to safely operate their aircraft without the control requirements of instrument flight rules (IFR) flight procedures, and weather minimum conditions are above the regulatory requirements for VFR flight, pilots may operate under VFR procedures. See FM 1-111.

vulnerability analysis — A process to determine which friendly elements are within the radius of vulnerability (RV) for a proposed friendly weapon of mass destruction target and whether they will be exposed to a radiation risk greater than emergency risk. (See also emergency risk (nuclear), radius of vulnerability (RV) (nuclear), and troop safety (nuclear) .) See FMs 3-3, 3-100, 100-30, JPs 3-12.2, and 3-12.3

W

walking patient (JP 1-02, NATO) — A patient not requiring a litter while in transit. (See also casualty and patient.) See FM 8-series.

war game (JP 1-02, NATO) — A simulation, by whatever means, of a military operation involving two or more opposing forces, using rules, data, and procedures designed to depict an actual or assumed real life situation.

war gaming — A step-by-step process of action, reaction, and counteraction for visualizing the execution of each friendly course of action (COA) in relation to enemy COAs and reactions. It explores the possible branches and sequels to the primary plan resulting in a final plan and decision points for critical actions. (See also battlefield visualization.) See FMs 71-100, 100-5, 100-15, and 101-5.

warned exposed (JP 1-02, NATO) — The vulnerability of friendly forces to nuclear weapon effects. In this condition, personnel are assumed to be prone with all skin covered and with thermal protection at least that provided by a two-layer summer uniform. (See also unwarned exposed and warned protected.) See FM 100-30, JPs 3-12.2, and 3-12.3.

warned protected (JP 1-02, NATO) — The vulnerability of friendly forces to nuclear weapon effects. In this condition, personnel are assumed to have some protection against heat, blast, and radiation such as that afforded in closed armored vehicles or crouched in fox holes with improvised overhead shielding. See also unwarned exposed and warned exposed. See FM 100-30, JPs 3-12.2, and 3-12.3.

warning order (WARNO) (JP 1-02, NATO) — **1.** A preliminary notice of an order or action which is to follow. **2.** A crisis action planning directive issued by the Chairman of the Joint Chiefs of Staff that initiates the development and evaluation of courses of action by a supported commander and requests that a commander's estimate be submitted. **3.** A planning directive that describes the situation, allocates forces and resources, establishes command relationships, provides other initial planning guidance, and initiates subordinate unit mission planning. See FMs 1-111, 6-20, 7-20, 7-30, 17-95, 71-100, 71-123, 100-15, 100-40, 101-5, and JP 5-0.

OPERATIONAL TERMS AND GRAPHICS

wave (JP 1-02, NATO) — A formation of forces, landing ships, craft, amphibious vehicles or aircraft required to beach or land about the same time. Can be classified as to type, function, or order as shown: **a.** Assault wave; **b.** Boat wave; **c.** Helicopter wave; **d.** Numbered wave; **e.** On-call wave; **f.** Scheduled wave.

way point (JP 1-02) — In air operations, a point or a series of points in space to which an aircraft may be vectored. (Army) — A designated point or series of points loaded and stored in a global positioning system or other electronic navigational aid system to facilitate movement. **3-26**

weapon control status — The degree of fire control imposed upon Army units having assigned, attached, or organic air defense weapons. (See air defense weapon control status.)

weapon engagement zone (WEZ) (JP 1-02) — In air defense, airspace of defined dimensions within which the responsibility for engagement of air threats normally rests with a particular weapon system. **a. fighter engagement zone (FEZ).** In air defense, that airspace of defined dimensions within which the responsibility for engagement of air threats normally rests with fighter aircraft. **b. high-altitude missile engagement zone (HIMEZ).** In air defense, that airspace of defined dimensions within which the responsibility for engagement of air threats normally rests with high-altitude surface-to-air missiles. **c. low-altitude missile engagement zone (LOMEZ).** In air defense, that airspace of defined dimensions within which the responsibility for engagement of air threats normally rests with low- to medium-altitude surface-to-air missiles. **d. short-range air defense engagement zone (SHORADEZ).** In air defense, that airspace of defined dimensions within which the responsibility for engagement of air threats normally rests with short-range air defense weapons. It may be established within a low- or high-altitude missile engagement zone. **e. joint engagement zone (JEZ).** In air defense, that airspace of defined dimensions within which multiple air defense systems (surface-to-air missiles and aircraft) are simultaneously employed to engage air threats. **3-6**

weapons free (JP 1-02, NATO) — In air defense, a weapon control order imposing a status whereby weapons systems may be fired at any target not positively recognized as friendly. (See also weapons hold, weapons tight, and air defense weapon control status.) See FM 44-100.

weapons free zone (JP 1-02) — An air defense zone established for the protection of key assets or facilities, other than air bases, where weapon systems may be fired at any target not positively recognized as friendly. (See also weapons free and air defense weapon control status.) See FMs 100-103 and 44-100.

3-7

weapons hold (JP 1-02, NATO) — In air defense, a weapon control order imposing a status whereby weapons systems may only be fired in self-defense or in response to a formal order. (See also weapons free, weapons tight, and air defense weapon control status.) See FM 44-100.

weapon signature — Any smoke, vapor trail, noise, heat, flash, tracer, or flight characteristic that denotes a specific weapon system. (See also signature.)

weapons of mass destruction (JP 1-02) — In arms control usage, weapons that are capable of a high order of destruction and/or of being used in such a manner as to destroy large numbers of people. Can be nuclear, chemical, biological, and radiological weapons, but excludes the means of transporting or propelling the weapon where such means is a separable and divisible part of the weapon.

weapons tight (JP 1-02, NATO) — In air defense, a weapon control order imposing a status whereby weapons systems may be fired only at targets recognized as hostile. (See also air defense, weapons free, and weapons hold.)

weathering — The process of decontamination by natural evaporation or decomposition of the chemical agent. See FM 3-100.

wedgeformation — A unit formation with subordinate elements in a V formation with the point toward the suspected or templated enemy positions. This facilitates control and transition to the assault (line formation). The wedge provides maximum firepower forward and good firepower to the flanks. (See also vee formation and formation.) See FMs 7-7, 7-8 and 7-20.

white lists — Listings that identify and locate individuals who have been identified as being of intelligence or counterintelligence interest and who are expected to be able to provide information or assistance in existing or new intelligence areas of interest. The individuals are usually in accordance with, or favorably inclined toward, US policies. Contributions are based on a voluntary and cooperative attitude. **D-8**

white propaganda (JP 1-02) — Propaganda disseminated and acknowledged by the sponsor or by an accredited agency thereof.

withdrawal operation (JP 1-02, NATO) — A planned operation in which a force in contact disengages from an enemy force. (Army) — A type of retrograde where a force in contact **plans** to disengage from the enemy and move in a direction away from the enemy. (See retrograde.) **C-11**

world geographic reference system (GEOREF) (JP 1-02) — A worldwide position reference system that may be applied to any map or chart graduated in latitude and longitude regardless of projection. It is a method of expressing latitude and longitude in a form suitable for rapid reporting and plotting.

wounded in action (WIA) (JP 1-02) — A casualty category applicable to a hostile casualty, other than the victim of a terrorist activity, who has incurred an injury due to an external agent or cause. The term encompasses all kinds of wounds and other injuries incurred in action, whether there is a piercing of the body, as in a penetration or perforated wound, or none, as in the contused wound. These include fractures, burns, blast concussions, all effects of biological and chemical warfare agents, and the effects of an exposure to ionizing radiation or any other destructive weapon or agent. The hostile casualty's status may be very seriously ill or injured, seriously ill or injured, incapacitating illness or injury, or not seriously injured.

wrong (JP 1-02) — A proword meaning, "Your last transmission was incorrect, the correct version is _____."

X

X-hour— The unspecified time that commences unit notification for planning and deployment preparation in support of potential contingency operations that do not involve rapid, no-notice deployment.

X-hour sequence — Extended sequence of events initiated by X-hour that allows a unit to focus on planning for a potential contingency operation, to include preparations for deployment.

Z

zone of action (JP 1-02, NATO) — A tactical subdivision of a larger area, the responsibility for which is assigned to a tactical unit; generally applied to offensive action. (Army) — The offensive operational area assigned to a unit or commander that is defined by a forward boundary, rear boundary, lateral boundaries, and a coordinating altitude. (See also sector.)

OPERATIONAL TERMS AND GRAPHICS

zone of fire (Army) — A maneuver control measure usually utilized during amphibious operations that is an area within which designated ground fire support units and naval gunfire support ships deliver, or are prepared to deliver, fire support. Fire may be observed or unobserved. The zone of fire is used to coordinate the efforts of the fire support ships and units with each other and with the ground scheme of maneuver. The size and location of a zone of fire is based on the ground force boundaries; the area in which the supporting ships and units can provide effective fire; visibility; range of the ship's guns; and the height of intervening terrain. (See also fire support area (FSA), fire support station (FSS), and naval gunfire support (NGFS).) See FM 6-series.

zone reconnaissance — A directed effort to obtain detailed information concerning all routes, obstacles (to include chemical or radiological contamination), terrain, and enemy forces within a zone defined by boundaries. A zone reconnaissance normally is assigned when the enemy situation is vague or when information concerning cross-country trafficability is desired. (See also reconnaissance (recon) (recce).)

zone of separation (ZOS) — That space controlled by a third-party neutral force that enforces the parameters specified by international agreement, ceasefire agreement, or United Nations mandate.

D-10

ZULU time — A measure of time that conforms, within a close approximation, to the mean diurnal rotation of the Earth and serves as the basis of civil timekeeping. ZULU time is determined from observations of the stars, radio sources, and also from ranging observations of the Moon and artificial Earth satellites. The scale determined directly from such observations is designated Universal Time Observed (UTO); it is slightly dependent on the place of observation. When ZULU time is corrected for the shift in longitude of the observing station caused by polar motion, the time scale ZULU time is obtained. Formerly called Greenwich Mean Time (See also Universal Time.) See FM 101-5.

Chapter 2

Operational Acronyms and Abbreviations

— A

A/A	air to air
AA	avenue of approach; assembly area
AAA	antiaircraft artillery
A²C²	Army airspace command and control
AADC	area air defense commander
AAP	Allied Administrative Publication
AASLT	air assault
AAW	antiair warfare
abn	airborne
ABCCC	airborne battlefield command and control center
ABCS	Army Battle Command System
ACA	airspace coordination area; airspace control authority
ACE	air combat element (NATO); analysis and control element; aviation combat element (USMC)
acft	aircraft
ACL	allowable combat load; allowable cabin load
ACM	airspace control measures
ACO	airspace control order
ACP	air control point; Allied Communications Publication
acq	acquisition
ACR	armored cavalry regiment
ACT	analysis control team
AD	air defense; armored division
ADA	air defense artillery
ADC	area damage control; assistant division commander
ADC(M)	assistant division commander (maneuver)
ADC(S)	assistant division commander (support)
ADM	atomic demolition munitions
admin	administrative
ADOA	air defense operations area
ADP	automated data process(ing)
AEW	airborne early warning
AFSOC	Air Force special operations component
A/G	air to ground
AG	adjutant general
AGL	above ground level
AGM	air-to-ground missile
AGS	Armored Gun System (light tank)

OPERATIONAL TERMS AND GRAPHICS

AI	air interdiction
AIM	air intercept missile
AJ	Azerbaijan
ALCE	airlift control element
ALO	air liaison officer; artillery liaison officer
alt	altitude, alternate
AMB	air mission brief; air mobility branch
AMC	air mission commander
ammo	ammunition
ANGLICO	air/naval gunfire liaison company
AO	area of operations
AOA	amphibious objective area
AOC	air operations center
AOI	area of interest
AOR	area of responsibility
AP	antipersonnel
APC	armored personnel carrier
APOD	aerial port of debarkation
APOE	aerial port of embarkation
APP	Allied Procedural Publication
AQ	Samoa (US)
AR	Army regulation; armor
ARFOR	Army forces
ARG	amphibious ready group
armd	armored
ARSOA	Army special operations aviation
ARSOF	Army special operations forces
ARSOTF	Army special operations task force
arty	artillery
AS	Australia; area security
ASCC	Army service component commander
ASL	authorized stockage list; allowable supply list
aslt	assault
ASLT PSN	assault position (graphics)
ASM	antiship missile
ASOC	air support operations center
ASP	ammunition supply point
ASR	alternate supply route; ammunition supply rate
ASW	antisubmarine warfare
AT	antiterrorism; antitank
ATACMS	Army Tactical Missile System
ATC	air traffic control
ATF	amphibious task force
atk	attack

ATK PSN	attack position (graphics)
ATM	air tasking message (Army)
ATO	air tasking order
ATP	ammunition transfer point; Allied Tactical Publication
AVIM	aviation intermediate maintenance
AVLB	armored vehicle-launched bridge
AVLM	armored vehicle-launched mine clearing
AVLO	aviation liaison officer
avn	aviation
AWACS	Airborne Warning and Control System
AXP	ambulance exchange point

B

B	biological (graphics)
BA	Bahrain
BAI	battlefield air interdiction
BAS	battalion aid station
BC	battle command
BCC	battlefield circulation control
BCD	battlefield coordination detachment
BCOC	base cluster operations center
BDA	battle damage assessment
BDAR	battle damage assessment and repair
bde	brigade
BDOC	base defense operations center
BDU	battle dress uniform
BDZ	base defense zone
BE	Belgium
BF	beginning of radioactive fallout
BFV	Bradley fighting vehicle
BH	Belize
BICC	battlefield information coordination center
biol	biological
BK	Bosnia-Herzegovina
BL	Bolivia
BMCT	begin morning civil twilight
BMNT	begin morning nautical twilight
bn	battalion
BO	Belarus
BOS	battlefield operating systems
BP	battle position
BPAD	broadcast public affairs detachment
B/P	be-prepared mission

OPERATIONAL TERMS AND GRAPHICS

BPSE	brigade PSYOP support element
BR	Brazil
BRAA	bearing, range, altitude, aspect
BSA	brigade support area
btry	battery
BU	Bulgaria
BZ	buffer zone

C

C	chemical (graphics)
C²	command and control
C²W	command and control warfare
C³	command, control, and communications
C³CM	command, control, and communications countermeasures
C³I	command, control, communications, and intelligence
C⁴I	command, control, communications, computers, and intelligence
CA	Canada; civil affairs; combat assessment
cal	caliber
CALFEX	combined arms live fire exercise
CAP	crisis action planning; combat air patrol
CARP	computed air release point
CARS	combat arms regimental system
cas	casualty
CAS	close air support
CATF	commander, amphibious task force
CATK	counterattack (graphics)
cav	cavalry
cbt	combat
CCIR	commander's critical information requirements
CCL	combat-configured load
CCP	communications checkpoint
CCT	combat control team
CD	chemical defense; counterdrug; Chad
C-day	unnamed day on which a deployment operation commences or is to commence
CDM	chemical downwind message
CDS	container delivery system
CE	command element
CENTCOM	United States Central Command
CEP	circular error probable
CEWI	combat electronic warfare and intelligence
CFA	covering force area; call forward area
CFL	coordinated fire line

CG	commanding general
cGy	centigray
CH	China; chaplain
chem	chemical
CHS	combat health support
CI	combat intelligence; counterintelligence; Chile
CINC	commander of a combatant command; commander in chief
CJCS	Chairman of the Joint Chiefs of Staff
CJTF	commander, joint task force
CLF	commander, landing force
CLR STA	clearing station (graphics)
cmd	command
CMO	civil-military operations
CMOC	civil-military operations center
co	company
CO	commanding officer; Colombia
COA	course of action
COCOM	combatant command (command authority)
COFM	correlation of forces and means
COLT	combat observation and lasing team
COMINT	communications intelligence
comm	communications
COMMZ	communications zone
COMSEC	communications security
CONPLAN	concept plan
const	construction
CONUS	continental United States
COSCOM	corps support command
CP	command post
CPSE	corps PSYOP support element
CPX	command post exercise
CS	combat support; Costa Rica
CSAR	combat search and rescue
CSC	combat stress control
CSH	corps surgical hospital
CSR	controlled supply rate
CSS	combat service support
CSSE	combat service support element
CT	counterterrorism
CTCP	combat trains command post
CU	Cuba
CUWTF	Combined Unconventional Weapons Task Force
CW	chemical warfare
CY	Cyprus
CZ	combat zone

OPERATIONAL TERMS AND GRAPHICS

D

D	dental (graphics)
DA	Denmark; direct action
DAO	division ammunition officer
DCA	defensive counterair; Defense Communications Agency
DCM	deputy chief of mission
DCS	defensive counterspace; Defense Communications System
D-day	unnamed day on which a particular operation commences or is to commence
D-3	3 days prior to D-day
D+7	7 days after D-day
D+90	90 days after D-day
DE	directed energy
DEFCON	defense readiness condition
det cord	detonation cord
DEW	directed-energy warfare
DFSCOORD	deputy fire support coordinator
DGZ	desired ground zero
DISCOM	division support command
DISE	division intelligence support element
DISUM	daily intelligence summary
div	division
DLIC	detachment left in contact
DMZ	demilitarized zone
DOA	direction of attack
DOD	Department of Defense
DOS	day of supply
DOW	died of wounds
DP	decision point
DPSE	division PSYOP support element
DPU	data processing unit
DR	Dominican Republic
DRB	division ready brigade
DS	direct support
DSA	division support area
DSM	decision support matrix
DST	decision support template
DSU	direct support unit
DTG	date-time group
DWRIA	died of wounds received in action
DZ	drop zone

E

EA	engagement area; electronic attack; emergency action
EAC	echelons above corps
EAD	echelons above division
EC	Ecuador
ECM	electronic countermeasures
E&E	evasion and escape
EECT	end evening civil twilight
EEFI	essential elements of friendly information
EEI	essential elements of information
EENT	end evening nautical twilight
EF	end of radioactive fallout
eff	effective
EG	Egypt
EI	Ireland
ELINT	electronic intelligence
ELSEC	electronics security
EMCON	emission control
EMI	electromagnetic interference
EMP	electromagnetic pulse
EN	engineer (unit designations; graphics)
ENCOORD	engineer coordinator
engr	engineer
ENY	enemy (graphics)
EOD	explosive ordnance disposal
EP	electronic protection
EPW	enemy prisoner of war
equip	equipment
ERP	engineer regulating point
ES	electronic warfare support; El Salvador
ESM	electronic warfare support measures; electronic surveillance measures
EUCOM	European Command
EW	electronic warfare
EZ	extraction zone

F

FA	field artillery
FAA	forward assembly area
FAAD	forward area air defense
FAADEZ	forward area air defense engagement zone
FAAWC	force anti-air warfare commander
FAC	forward air controller

OPERATIONAL TERMS AND GRAPHICS

FAC(A)	forward air controller (airborne)
FARP	forward arming and refueling point
FASCAM	family of scatterable mines
fax	facsimile
FB	fire base
FCC	flight coordination center
FCL	final coordination line
FDC	fire direction center
FDO	flexible deterrent option ; fire direction officer
FDRP	first destination reporting point
FEBA	forward edge of the battle area
FES	forced entry system
FEZ	fighter engagement zone
FFA	free-fire area
FFCC	friendly forces coordination center; force fires coordination center
FFIR	friendly forces information requirements
FH	field hospital
FID	foreign internal defense
FISINT	foreign instrumentation signals intelligence
FIST	fire support team
FLB	forward logistics base
fld	field
FLE	forward logistics element
FLO	fighter liaison officer
FLOT	forward line of own troops
FM	field manual; frequency modulated/modulation
FMC	fully mission capable
FMF	Fleet Marine Force
FO	forward observer
FOB	forward operations base
FOC	flight operations center
FPF	final protective fire
FPL	final protective line
FR	France
FRAGO	fragmentary order
FSA	forward support area (NGFS)
FSB	forward support battalion
FSC	fire support coordinator (USMC)
FSCC	fire support coordination center (USMC)
FSCL	fire support coordination line
FSCM	fire support coordinating measure
FSCOORD	fire support coordinator
FSE	fire support element
FSO	fire support officer

FSS	fire support station (NGFS)
FSSG	force service support group
FTCP	field trains command post
 fwd	forward
FY	Former Yugoslav Republic of Macedonia (FYROM)

G

G1	Assistant Chief of Staff, Personnel
G2	Assistant Chief of Staff, Intelligence
G3	Assistant Chief of Staff, Operations
G4	Assistant Chief of Staff, Logistics
G5	Assistant Chief of Staff, Civil Affairs
G6	Assistant Chief of Staff, Communications
GA	nerve agent tabun
GB	nerve agent sarin
GCC	Gulf Cooperation Council
GCE	ground combat element
GD	nerve agent soman
GE	Germany
GEOREF	geographic reference
GG	Georgia (the nation)
GIE	global information environment
GMT	Greenwich Mean Time
gp	group
GPS	global positioning system
GR	Greece
GS	general support
GSM	ground station module
GSR	general support-reinforcing; ground surveillance radar
GT	Guatemala
GW	guerrilla warfare
GZ	ground zero

H

HA	Haiti; holding area; humanitarian assistance
HACC	humanitarian assistance coordination center
HAHO	high-altitude high-opening (parachute technique)
HALO	high-altitude low-opening (parachute technique)
HARM	high-speed antiradiation missile
HCA	humanitarian and civic assistance
HD	heavy drop; blister agent (distilled Levinstein mustard)
HE	high explosive

OPERATIONAL TERMS AND GRAPHICS

hel	helicopter
HELO	helicopter
HET	heavy equipment transporter
HF	high frequency
H-hour	specific hour on D-day at which a particular operation commences
H-3	3 hours prior to H-hour
H+7	7 hours after H-hour
H+30 min	30 minutes after H-hour
HHB	headquarters and headquarters battery (FA and ADA)
HHC	headquarters and headquarters company
HHT	headquarters and headquarters troop (cavalry units)
HIDACZ	high-density airspace control zone
HIMAD	high-altitude missile air defense
HL	blister agent (mustard-lewisite mixture)
HMMWV	high-mobility multipurpose wheeled vehicle
HN	host nation; blister agent (nitrogen mustard)
HO	Honduras
HOB	height (depth) of burst
hos	hostile
HPRF	high pulse repetition frequency
HPT	high-payoff target
HQ	headquarters
HR	Croatia
H&S	headquarters and service
HT	blister agent (mustard T-mixture)
HU	Hungary
HUMINT	human intelligence
HVT	high-value target

ICAC²	integrated combat airspace command and control
ID	identification; infantry division
IDAD	internal defense and development
IDP	initial delay position
IED	imitative electromagnetic deception
IEW	intelligence and electronic warfare
IFF	identification, friend or foe (radar)
IFV	infantry fighting vehicle
IG	inspector general
IHL	intelligence handover line
IMINT	imagery intelligence
IN	India; infantry
inf	infantry

INFOSEC	information security
INTSUM	intelligence summary
IPB	intelligence preparation of the battlefield
IPW	prisoner of war interrogation
IR	information requirements; infrared, thermal; Iran
IS	Israel
ISB	intermediate staging base
ISE	intelligence support element
ISS	information system security
IT	Italy
IV	intravenous
IW	information warfare
IZ	Iraq

J

JA	Japan
JAAT	joint air attack team
JCATF	joint civil affairs task force
JCS	Joint Chiefs of Staff
JCSE	joint communications support element
JDISS	Joint Deployable Intelligence Support System
JEZ	joint engagement zone
JFACC	joint force air component commander
JFC	joint force commander
JFLCC	joint force land component commander
JFMCC	joint force maritime component commander
JFSOCC	joint force special operations component commander
JIB	Joint Information Bureau
JIC	joint intelligence center
JLOTS	joint logistics over-the-shore
JMC	joint movement center
JO	Jordan
JOA	joint operations area
JOC	joint operations center
JOPES	Joint Operation Planning and Execution System
JP	joint publication
JPOTF	joint psychological operations task force
JRC	joint reception center
JSEAD	joint suppression of enemy air defenses
JSOA	joint special operations area
JSOACC	joint special operations air component commander
JSOLE	joint special operations liaison element
JSOTF	joint special operations task force

OPERATIONAL TERMS AND GRAPHICS

JSTARS	Joint Surveillance Target Attack Radar System
JTB	joint target board
JTF	joint task force
JUWC	Joint Unconventional Warfare Command
JUWTF	Joint Unconventional Warfare Task Force

— K

KIA	killed in action
km	kilometer
KN	Korea (North)
KS	Korea (South)
kt	kiloton
KU	Kuwait
KZ	Kazakhstan

— L

L	light (refers to light infantry) (graphics)
LAB	logistics assault base
LANTCOM	United States Atlantic Command
LAPES	low-altitude parachute extraction system
LAV	light armored vehicle
LC	line of contact
LCC	land component commander
LD	line of departure
LD/LC	line of departure is line of contact
LE	Lebanon
LEN	large extension node
LF	landing force
LG	Latvia
LH	Lithuania
LIWA	land information warfare agency
LL	light line; latent lethality
LLTR	low-level transit route
LNO	liaison officer
LO	lubrication order; law and order; Slovakia
LOA	limit of advance
LOC	lines of communications
LOD	line of demarcation
LOGPAC	logistics package
LOS	line of sight
LOTS	logistics over-the-shore
LP/OP	listening post/observation post (USMC)
LRP	logistics release point

LRS	long-range surveillance
LRS D	long-range surveillance detachment
LRSU	long-range surveillance unit
LSD	least separation distance
LTD	laser target designator
LU	Luxembourg
LY	Libya
LZ	landing zone

M

M	mechanized (graphics)
MACCS	Marine air command and control system
MACG	Marine air control group
MACS	Marine air control squadron
MAG	Marine aircraft group
MAGTF	Marine air-ground task force
MAIN	primary command post (graphics)
maint	maintenance
MALS	Marine aviation logistics squadron
MarDiv	Marine division
MASINT	measurement and signature intelligence
MASS	Marine air support squadron
max	maximum
MBA	main battle area
MCM	mine countermeasures
MCRP	Marine Corps Reference Publication
MD	Moldavia; medium division
M-day	mobilization day
mech	mechanized
med	medical
MED	manipulative electromagnetic deception
MEDEVAC	medical evacuation
MEF	Marine expeditionary force
MEF(FWD)	Marine expeditionary force (forward)
met	meteorological
METL	mission essential task list
METT-T	mission, enemy, terrain, troops, and time available (Army); mission, enemy, terrain and weather, troops and support available, and time available (USMC)
MEU	Marine expeditionary unit
MEZ	missile engagement zone
MFF	military free fall
MG	Mongolia; machine gun
MHE	materials handling equipment
MI	military intelligence

OPERATIONAL TERMS AND GRAPHICS

MICLIC	mine clearing line charge
MIE	military information environment
MIJI	meaconing, interference, jamming, and intrusion
MILSTD	military standard
min	minimum
MIST	military information support team
MLC	military load classification
MLRS	multiple launch rocket system
mm	millimeter
MOB	main operations base
MOBA	military operations in a built-up area
MOOTW	military operations other than war (joint only)
MOPP	mission-oriented protective posture
MOUT	military operations on urbanized terrain
MP	military police
MPA	mission planning agent; manpower authorization; maritime patrol aircraft
MPC	military pay certificate
MPF	maritime prepositioning force
MPRF	medium pulse repetition frequency
MRC	major regional conflict/contingency
MRE	meal, ready to eat
MRR	motorized rifle regiment; minimum-risk route
MSB	main support battalion
MSC	Military Sealift Command; major subordinate command
MSD	minimum safe distance
MSR	main supply route
MSL	mean sea level
mt	megaton
MST	maintenance support team
MTF	medical treatment facility
MTT	mobile training team
MU	Oman
MX	Mexico

N

NAI	named area of interest
NATO	North Atlantic Treaty Organization
NAVSO	naval special operations forces
NBC	nuclear, biological, and chemical
NBCWRS	nuclear, biological, and chemical warning and reporting system
NCA	National Command Authorities
NCS	net control station
NCTR	noncooperative target recognition
NEO	noncombatant evacuation operations

NFA	no-fire area
NFL	no-fire line
NGFS	naval gunfire support
NGLO	naval gunfire liaison officer
NGO	nongovernmental organizations
NI	Nigeria
NIST	national intelligence support team
NL	Netherlands
NLT	not later than
NMCM	not mission capable, maintenance
NMCS	not mission capable, supply
NO	Norway
NOTAM	notice to airman
NPG	network participating group
NSFS	naval surface fire support
NSWG	naval special warfare group
NSWU	naval special warfare unit
NU	Nicaragua
NVD	night vision device
NZ	New Zealand

O

OAS	offensive air support
obj	objective
OCA	offensive counterair
OCOKA	observation, concealment, obstacles, key terrain, and avenue of approach (Army)
OCS	offensive counterspace
OEG	operation exposure guide
OP	observation post
OPCOM	operational command (NATO)
OPCON	operational control
OPLAN	operation plan
opns	operations
OPORD	operation order
OPSEC	operations security
OPTEMPO	operational tempo
OT	observer-target

P

PA	Paraguay; public affairs
PAA	position area for artillery
PACOM	United States Pacific Command
PD	point of departure

OPERATIONAL TERMS AND GRAPHICS

PDB	PSYOP dissemination battalion
PDF	principal direction of fire
PE	Peru
PERINTSUM	periodic intelligence summary
pers	personnel
PGIF	predicted ground impact point
PIR	priority intelligence requirements
PIREP	pilot report
PK	Pakistan
PL	phase line; Poland
PLD	probable line of deployment
plt	platoon
PM	provost marshal; preventive maintenance; Panama
PMCS	preventive maintenance checks and services
PNL	prescribed nuclear load
PO	Portugal
POD	port of debarkation
POE	port of embarkation
POG	psychological operations group
POL	petroleum, oils, and lubricants
POTF	PSYOP task force
PP	passage point
PRF	pulse repetition frequency
PS	personnel services
PSE	PSYOP support element
psn	position
PSYOP	psychological operations
pub	publication
PUP	pop-up point
PVNTMED	preventive medicine
PVO	private voluntary organizations
PW	prisoner of war
PWRS	prepositioned war reserve stock
PZ	pickup zone
PZCO	pickup zone control officer

— Q —

QA	Qatar
-----------	-------

— R —

R	reinforcing
R³P	rearm, refuel, and resupply point
RAA	rear assembly area

RAAMS	route antiarmor mine system
RAD	radiation absorbed dose
RAOC	rear area operations center
RAS	rear area security
RAU	remote access unit
RCA	riot control agent
RD	radius of damage
REAR	rear command post (graphics)
recon	reconnaissance
regt	regiment
REMS	remotely employed sensor
RES	radiation exposure status
retrans	retransmission
RFA	restrictive fire area
RFI	request for intelligence/information
RFL	restrictive fire line
RGR	ranger (graphics)
RHU	replacement holding unit
RIP	relief in place
RISTA	reconnaissance, intelligence, surveillance, and target acquisition. <i>See</i> RSTA also.
RL	release line
RO	Romania
ROE	rules of engagement
ROI	rules of interaction
ROM	refuel on the move
ROTA	releases other than attack (related nuclear, biological, and chemical)
ROZ	restricted operations zone
RP	Republic of Philippines; release point
RPB	regional PSYOP battalion
RPV	remotely piloted vehicle
RQ	Puerto Rico
RS	Russia; radiation status
RSO&I	reception, staging, onward movement, and integration
RSR	required supply rate
RSTA	reconnaissance, surveillance, and target acquisition
RV	radius of vulnerability
RW	Rwanda
RWR	radar warning receiver

S

S	scatterable mines (graphics)
SA	Saudi Arabia
S/A	surface to air

OPERATIONAL TERMS AND GRAPHICS

SAAFR	standard use Army aircraft flight route
SAB	separate armored brigade
SAR	search and rescue
SAEDA	subversion and espionage directed against the Army
SALUTE	size, activity, location, unit, time, and equipment
SAM	surface-to-air missile
SASP	special ammunition supply point
SAT	security assistance team
SATCOM	satellite communications
SBF	support by fire
SBU	special boat unit
SCI	sensitive compartmented information
SEAD	suppression of enemy air defenses
SEAL	sea-air-land team
SECDEF	Secretary of Defense
SEN	small extension node
SERE	survival, evasion, resistance, and escape
SF	special forces
SFC	special forces command
SFOB	special forces operations base
SFOD-ABC	special forces operational detachment Alpha/Bravo/Charlie
SHAPE	Supreme Headquarters Allied Powers Europe
SHELREP	shelling report
SHF	super-high frequency
SI	Slovenia
SIB	separate infantry brigade
SIDPERS	Standard Installation Division Personnel System
SIF	selective identification feature
sig	signal
SIGINT	signals intelligence
SIGSEC	signals security
SITMAP	situation map
SITREP	situation report
SJA	staff judge advocate
SO	special operations; Somalia
SOCCE	special operations command and control element
SOCORD	special operations coordinator
SOF	special operations forces
SOFA	status-of-forces agreement
SOI	signal operating instructions
SOLL	special operations low-level
SOP	standing operating procedures
SOSB	special operations support battalion

SOSCOM	special operations support command
SOSR	suppress, obscure, secure, and reduce
SOT-A/B	special operations team Alpha/Bravo
SOUTHCOM	United States Southern Command
S&P	stake and platform
SP	start point; strongpoint; self-propelled; Spain
SPOD	seaport of debarkation
SPOE	seaport of embarkation
SPOTREP	spot report
spt	support
sqdn	squadron
SRD	secret restrictive data
ST	SEAL team
STANAG	standardization agreement (NATO)
SU	Sudan
SUPCOM	support command
SURFREP	surf report
svc	service
SY	Syria

T

TAACOM	Theater Army Area Command
TAB	target acquisition battery
tac	tactical
TAC	tactical command post; tactical (artillery, naval gunfire, and close air support) (graphics)
TACAN	tactical air navigation
TACC	tactical air control center (USN); tactical air command center (USMC)
TACCP	tactical command post
TACON	tactical control
TACP	tactical air control party
TACSAT	tactical satellite
TADIL	tactical digital information link
TAF	tactical air force
TAI	targeted area of interest
TALCE	tanker airlift control element
TALO	tactical air liaison officer; theater airlift liaison officer
TAV	total asset visibility
TBM	tactical ballistic missile; theater ballistic missile
TCF	tactical combat force
TCP	traffic control post
TDA	table of distribution and allowances
TEB	tactical exploitation brigade

OPERATIONAL TERMS AND GRAPHICS

TECHCON	technical control
TECHINT	technical intelligence
TF	task force
tgt	target
THREATCON	threat condition
TI	Tajikistan
TIRS	terrain index reference system
tm	team
TM	theater missile
TMD	theater missile defense
TOC	tactical operations center
TOE	table of organization and equipment
TOR	terms of reference
TOT	time on target (naval gunfire, mortar, and close air support)
TOW	tube-launched, optically tracked, wire-guided, heavy antitank missile system
TPFDD	time-phased force and deployment data
TPFDL	time-phased force and deployment list
TPT	tactical PSYOP team
TRADOC	United States Army Training and Doctrine Command
trans	transportation
TRP	target reference point
TS	Tunisia; top secret
TU	Turkey
TX	Turkmenistan

U

UAV	unmanned aerial vehicle
UGS	unattended ground sensors
UHF	ultrahigh frequency
UK	United Kingdom
UMCP	unit maintenance collection point
UN	United Nations
UP	Ukraine
US	United States
USAF	United States Air Force
USASOC	United States Army Special Operations Command
USCG	United States Coast Guard
USFK	United States Forces Korea
USMC	United States Marine Corps
USN	United States Navy
UTM	universal transverse mercator
UW	unconventional warfare
UXO	unexploded explosive ordnance

UY Uruguay
UZ Uzbekistan

— V

V veterinary (graphics)
VE Venezuela
VFR visual flight rules
VHF very high frequency

— W

WARNO warning order
WCS weapons control status
WFZ weapons free zone
WIA wounded in action
WS Samoa Western

— Y

YE Yemen
YU Serbia and Montenegro Federal Republic

— Z

Z Zulu Time
ZI Zimbabwe
ZK Czech Republic
ZOS zone of separation
ZULU Universal Time

Chapter 3

Graphic Control Measures

The shadowed boxes 1-16 show the page number for the definition of a symbol or graphic in this chapter .

This chapter establishes a standard system for the use of graphic control measures. It applies to both automated and hand-drawn graphic displays or overlays. The control measures portrayed are for use on situation maps, overlays, and annotated aerial photographs. They are also the standard for all simulations, to include those used in live, virtual, and constructive environments.

GRAPHIC OVERLAYS

Overlays are graphics drawn on top of a map, sketch, or photograph. To ensure accurate alignment, the overlay must have at least two reference marks at opposite locations. On automated displays, overlays are graphical information that is joined electronically so that it can be “turned on or off” over or in front of the primary digital display, such as a map, sketch, or photograph.

All obstacles, friendly, enemy, neutral, or factional, will be drawn using the color green. These graphics are shown in the mobility and survivability section. All friendly graphic control measures will be shown in black when drawn manually or on a color display. Enemy graphic control measures will be shown in red. If red is not available, they will be drawn in black with a double line or the abbreviation “ENY” placed on the graphic in at least two places to avoid confusion. If other colors are used to show friendly or enemy (hostile) factions, then the colors used will be shown in a legend on the overlay describing what each color means.

USE OF GRAPHICS

This section describes how to label various graphic control measures. Some boundary labeling can be abbreviated when the abbreviation will not cause confusion. All text labeling should be drawn so that it can be read when the bottom of the overlay is closest to the reader. Labeling written on an angle should be readable when the overlay is turned a quarter of a turn (90 degrees) clockwise (to the left).

OPERATIONAL TERMS AND GRAPHICS

For **boundaries**, size markings should be perpendicular to the boundary line. For a corps boundary, use Roman numerals to show the number of the corps. A national abbreviation from Chapter 2 should be used if the boundary is between forces from different countries.

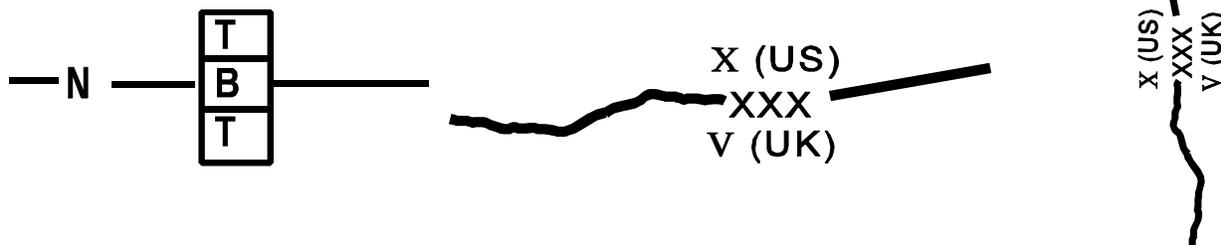

Field	Field Title	Description	Application	Length
B	Size Indicator	A symbol that denotes the size of a unit or installation (see Figure 4-5)	Units and installations	
N	Enemy (Hostile)	Indicated enemy by letters "ENY"	Enemy equipment, lines, areas, and boundaries	3
T	Unique Designation	An alphanumeric title that uniquely identifies a particular symbol; track number. Nuclear: friendly delivery unit (missile, satellite, aircraft, etc)	All	21

Fire support control measures should be labeled with the effective times, the controlling headquarters, and the abbreviation of the control measure. This labeling should be on both ends of the line and repeated as often as necessary for clarity along any line that passes through many boundaries.

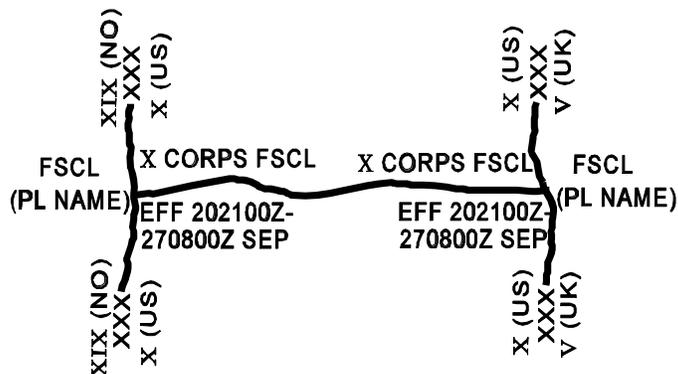

Most **lines** should be named as a phase line for easy reference during orders and radio transmissions. A phase line should be marked as “PL NAME.” Other lines that have a specific purpose and are also named as phase lines should have the primary purpose such as no fire line “NFL” labeled on top of the name and at both ends of the line or as often as necessary for clarity. The phase line labeling should be in parentheses.

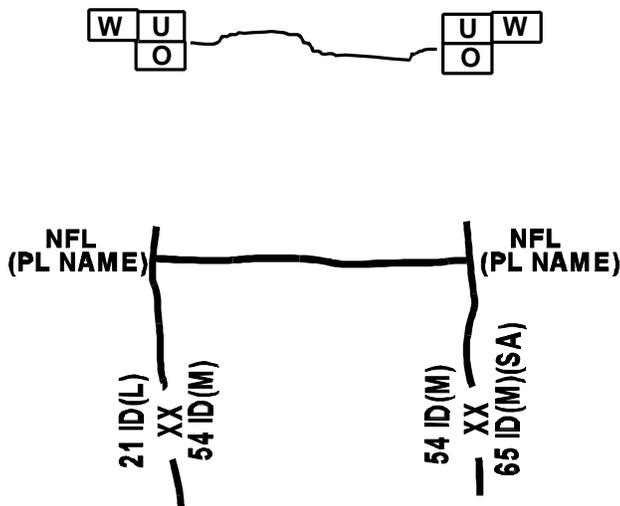

Field	Field Title	Description	Application	Length
O	Control Measure Code Name	A name given to a phase line and other control measures for easy reference and security when using in orders and in electromagnetic transmission. It is placed in parentheses below the abbreviation of a control measure.	Control measures	20
U	Control Measure Abbreviation	An abbreviation of a fire support or other control measure, such as LOA for limit of advance.	As necessary	4
W	Date-Time Group	Alphanumeric field for date/time (MIL-STD-2500A) (DDHHMMSSZMONYY) or “o/o” for on order.	All	15

OPERATIONAL TERMS AND GRAPHICS

Areas will normally be marked with the abbreviation for the type of area followed by a name. This labeling should be in the center of the area unless the area is too small or the labeling would interfere with the locating of units.

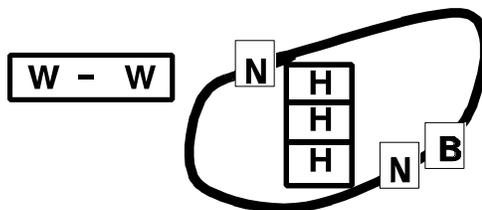

Field	Field Title	Description	Application	Length
B	Size Indicator	A symbol that denotes the size of a unit or installation (see Figure 4-5)	Units and installations	
H	Additional Information	Free text	All	20
N	Enemy (Hostile)	Indicated enemy by letters "ENY"	Enemy equipment, lines, areas, and boundaries	3
W	Date-Time Group	Alphanumeric field for date/time (MIL-STD-2500A) (DDHHMMSSZMONYY) or "o/o" for on order.	All	15

Points can be numbered, lettered, or a combination. An abbreviation for the point may be inside the point as in a passage point or release point, or on the upper right hand corner of the point symbol. Way points and targets are marked uniquely as shown later in this chapter.

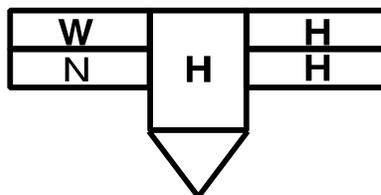

Field	Field Title	Description	Application	Length
H	Additional Information	Free text	All	20
N	Enemy (Hostile)	Indicated enemy by letters "ENY"	Enemy equipment, lines, areas, and boundaries	3
W	Date-Time Group	Alphanumeric field for date/time (MIL-STD-2500A) (DDHHMMSSZMONYY) or "o/o" for on order.	All	15

MANEUVER

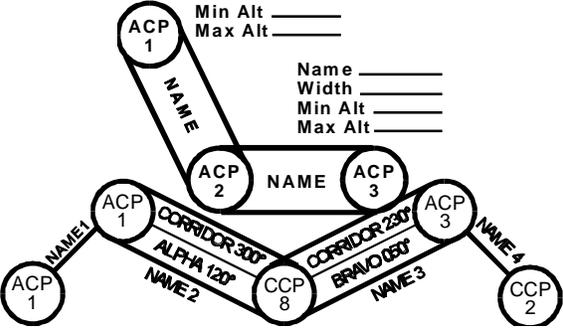
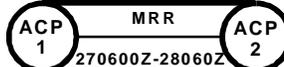
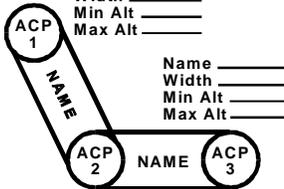
<p>Air Control Point (ACP) I-5</p>	
<p>Air Corridor I-5</p>	<p>Name _____ Width _____ Min Alt _____ Max Alt _____</p> <p>Name _____ Width _____ Min Alt _____ Max Alt _____</p> 
<p>Low-Level Transit Route (LLTR) I-94</p>	
<p>Minimum-Risk Route (MRR) I-101</p>	
<p>Standard Use Army Aircraft Flight Route (SAAFR) I-144</p>	<p>Name _____ Width _____ Min Alt _____ Max Alt _____</p> <p>Name _____ Width _____ Min Alt _____ Max Alt _____</p> 
<p>Unmanned Aerial Vehicle (UAV) Route</p>	
<p>Communications Checkpoint (CCP) I-35</p>	
<p>Downed Aircrew Pickup Point I-56</p>	

OPERATIONAL TERMS AND GRAPHICS

<p>Forward Area Air Defense Engagement Zone (FAADEZ)</p>	
<p>High-Density Airspace Control Zone (HIDACZ) <u>I-77</u></p>	
<p>Missile Engagement Zone (MEZ)</p>	
<p>Low altitude (LOMEZ)</p>	
<p>High altitude (HIMEZ)</p>	
<p>Restricted Operations Zone (ROZ) <u>I-133</u></p>	
<p>Pop-up Point (PUP) <u>I-122</u></p>	

Maneuver-Airspace (Continued)

<p>Weapons Free Zone (WFZ) 1-162</p>	
---	---

Maneuver-Deception

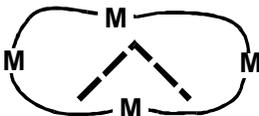
<p>Dummy (Deception) (decoy) 1-45</p>	
<p>Axis of Advance for Feint 1-64</p>	
<p>Decoy Infantry Battalion 1-46</p>	
<p>Direction of Attack for Feint 1-64</p>	
<p>Decoy Mined Area</p>	
<p>Decoy Mined Area, Fenced</p>	
<p>Dummy Minefield 1-57</p>	

OPERATIONAL TERMS AND GRAPHICS

Maneuver-Defensive

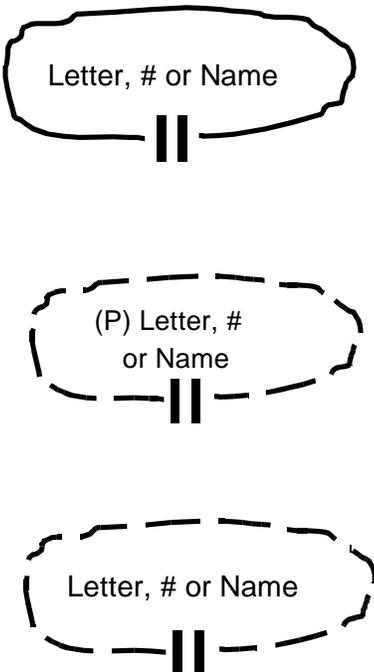
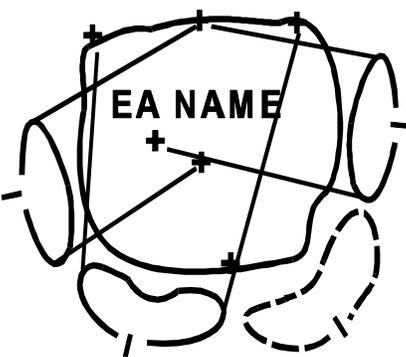
<p>Battle Position (BP) 1-18</p> <p>Occupied (Battalion sized unit)</p> <p>Prepared "(P)" but not occupied</p> <p>Planned</p>	 <p>Letter, # or Name</p> <p>(P) Letter, # or Name</p> <p>Letter, # or Name</p>
<p>Engagement Area 1-61</p>	 <p>EA NAME</p>

OPERATIONAL TERMS AND GRAPHICS

Maneuver-Defensive

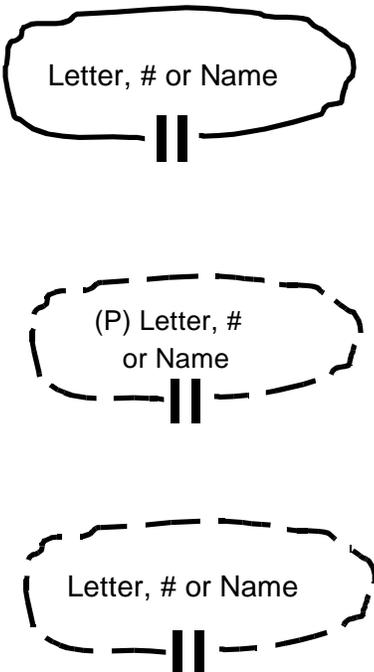
<p>Battle Position (BP) 1-18</p> <p>Occupied (Battalion sized unit)</p> <p>Prepared "(P)" but not occupied</p> <p>Planned</p>	
<p>Engagement Area 1-61</p>	

Maneuver-Defensive (Continued)

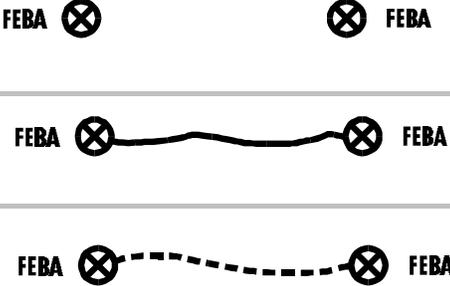
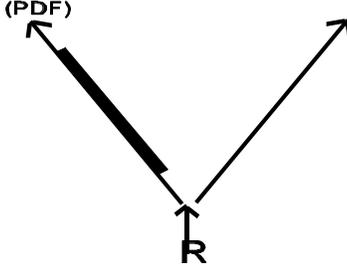
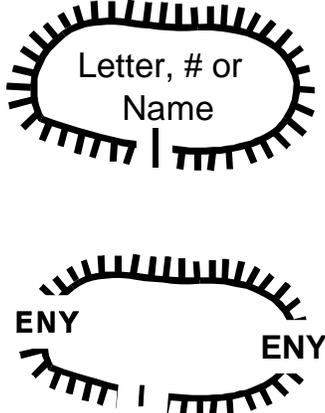
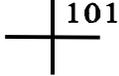
<p>Forward Edge of the Battle Area (FEBA) 1-70 Forward Edge of the Battle Area</p> <hr/> <p>Actual Trace of the FEBA</p> <hr/> <p>Proposed or On Order Trace of the FEBA</p>	
<p>Principal Direction of Fire (PDF) 1-123 (This shows an automatic rifle with the sector of fire between the two lines and with the arrows indicating the maximum effective range of the weapon or maximum range based on the terrain. The PDF is along the left side of the sector.)</p>	
<p>Strong Point 1-146 Friendly</p> <p>Enemy Known and Confirmed (Company sized)</p>	
<p>Target Reference Point (TRP) 1-152</p>	

OPERATIONAL TERMS AND GRAPHICS

Maneuver-General

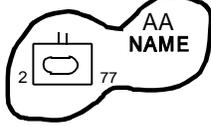
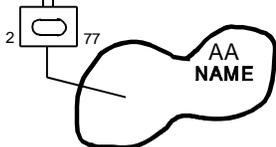
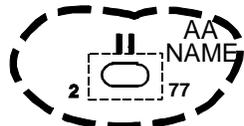
<p>Areas (General)</p> <p>Friendly</p>	
<p>Friendly Planned/On Order</p>	
<p>Enemy Known/Confirmed</p>	
<p>Enemy Suspected/Templated</p>	
<p>Assembly Areas 1-13</p> <p>Occupied</p>	
<p>Occupied</p>	
<p>Occupied by Multiple Units</p>	
<p>Proposed/On Order</p>	

OPERATIONAL TERMS AND GRAPHICS

Maneuver-General

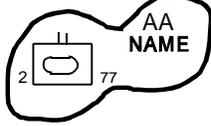
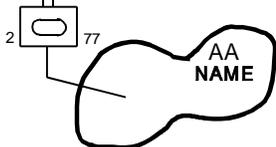
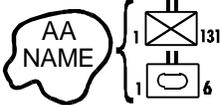
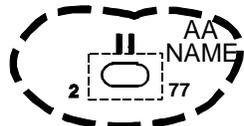
<p>Areas (General)</p> <p>Friendly</p>	
<p>Friendly Planned/On Order</p>	
<p>Enemy Known/Confirmed</p>	
<p>Enemy Suspected/Templated</p>	
<p>Assembly Areas 1-13</p> <p>Occupied</p>	
<p>Occupied</p>	
<p>Occupied by Multiple Units</p>	
<p>Proposed/On Order</p>	

Maneuver-General (Continued)

<p>Boundaries (General) 1-20</p> <p>Friendly Present (Size markings are always perpendicular or at a 90-degree angle to the boundary.)</p> <hr/> <p>Friendly Planned or On Order</p> <hr/> <p>Enemy Known</p> <hr/> <p>Enemy Suspected or Templated</p>	
<p>Boundaries (Lateral) 1-90</p>	
<p>Boundaries (Rear) 1-128 (Forward) 1-70</p> <p>(Corps are designated by Roman numerals.) (All text should be oriented as shown so that it is readable with the bottom nearest the reader or by turning the overlay one quarter turn clockwise.)</p>	

OPERATIONAL TERMS AND GRAPHICS

Maneuver-General (Continued)

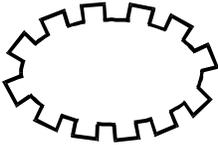
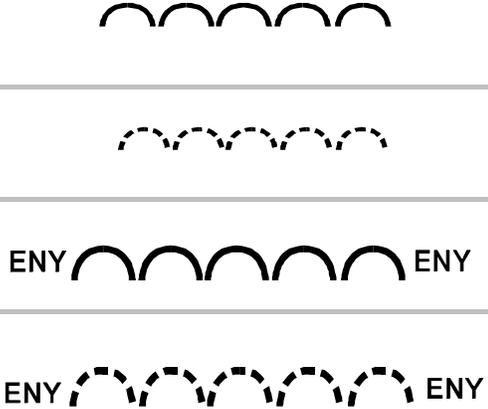
<p>Drop Zone (DZ) I-57</p>	
<p>Engagement Area (EA) I-61</p>	
<p>Extraction Zone (EZ) I-64</p>	
<p>Fortified Area I-65</p>	
<p>Forward Line of Own Troops (FLOT) I-70 Friendly Present</p> <hr/> <p>Friendly Planned or On Order</p> <hr/> <p>Enemy Known or Confirmed</p> <hr/> <p>Enemy Suspected or Templated</p>	

Maneuver-General (Continued)

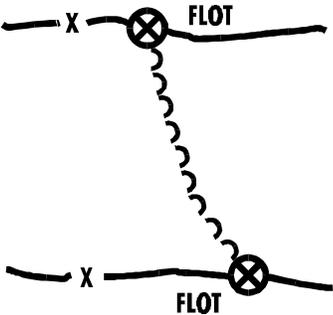
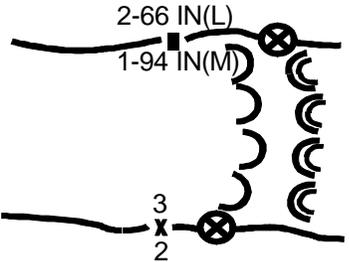
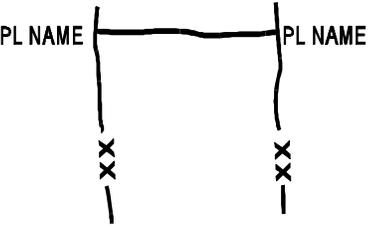
<p>Forward Line of Own Troops (Continued)</p>	
<p>Landing Zone (LZ) 1-89</p>	
<p>Line of Contact (LC) 1-91</p>	
<p>Phase Line (PL) 1-121</p>	
<p>Pickup Zone (PZ) 1-121</p>	

OPERATIONAL TERMS AND GRAPHICS

Maneuver-Offensive

<p>Assault Position I-13</p>	
<p>Attack by Fire Position I-13</p>	
<p>Attack Position I-13</p> <p>Friendly Attack Position (Actual)</p> <hr/> <p>Friendly Occupied (Only if a unit must stop in the attack position)</p> <hr/> <p>Friendly Planned, Proposed, or On Order</p>	 <hr/>  <hr/> 
<p>Axis of Advance I-14</p> <p>(The tip of the arrow should touch the objective or limit of the movement.)</p> <p>Friendly Aviation</p>	

Maneuver-Offensive (Continued)

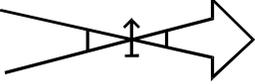
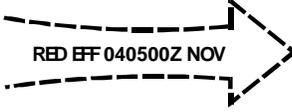
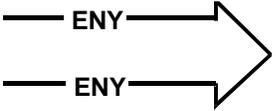
<p>Axis of Advance (Continued) Friendly Airborne</p>	
<p>Friendly Attack Helicopter</p>	
<p>Friendly Ground Axis of Supporting Attack I-147</p>	
<p>Friendly Ground Axis of Main Attack I-94</p>	
<p>Friendly Ground Axis On Order with Date and Time (if known) Effective</p>	
<p>Enemy Confirmed</p>	
<p>Enemy Templated</p>	
<p>Direction of Attack I-53 (The tip of the arrow should touch the objective or limit of the movement.) Friendly Aviation</p>	
<p>Friendly Aviation Planned or On Order</p>	

OPERATIONAL TERMS AND GRAPHICS

Maneuver-Offensive (Continued)

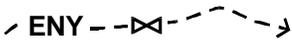
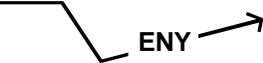
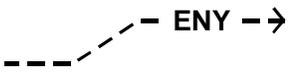
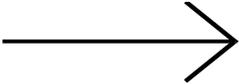
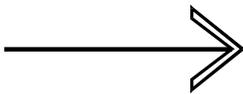
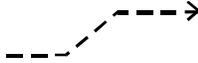
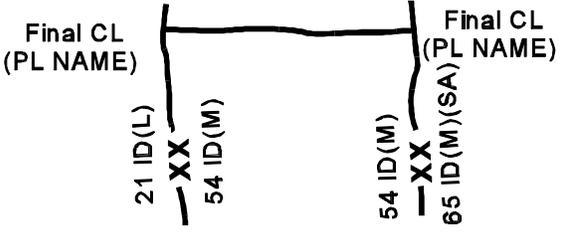
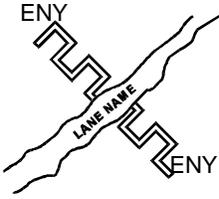
<p>Direction of Attack (Continued) I-53</p> <p>Enemy Known/Confirmed Aviation</p> <hr/> <p>Templated Enemy Aviation</p> <hr/> <p>Enemy Confirmed/Known Ground</p> <hr/> <p>Templated Enemy Ground</p> <hr/> <p>Friendly Direction of Supporting Attack I-147</p> <hr/> <p>Friendly Direction of Main Attack I-94</p> <hr/> <p>Friendly Planned or On Order</p>	 <hr/>  <hr/>  <hr/>  <hr/>  <hr/>  <hr/> 
<p>Final Coordination Line I-65</p>	
<p>Infiltration Lane I-81</p>	

Maneuver-Offensive (Continued)

<p>Limit of Advance (LOA) 1-91</p>	
<p>Line of Departure (LD) 1-91</p>	
<p>Line of Departure is Line of Contact (LD/LC) 1-92</p>	
<p>Objective 1-111</p>	
<p>Point of Departure (PD) 1-121</p>	

Maneuver-Offensive (Continued)

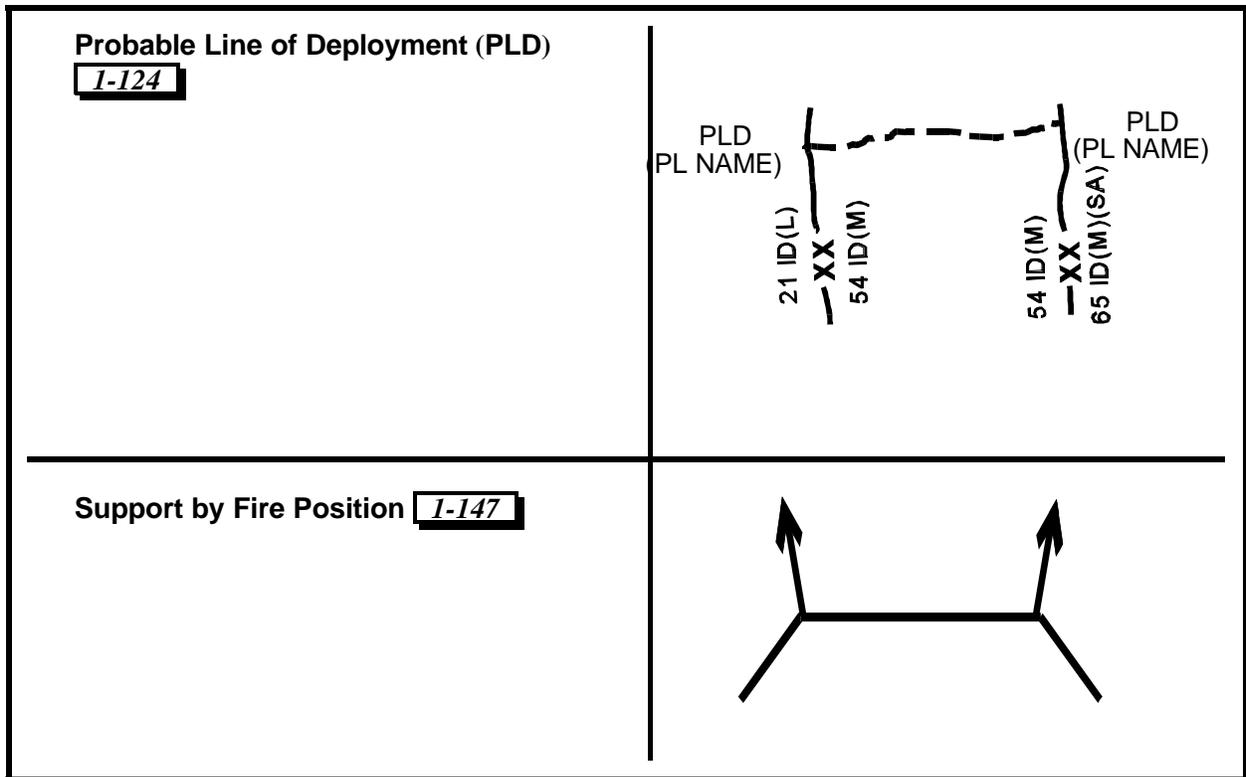

Maneuver-Special

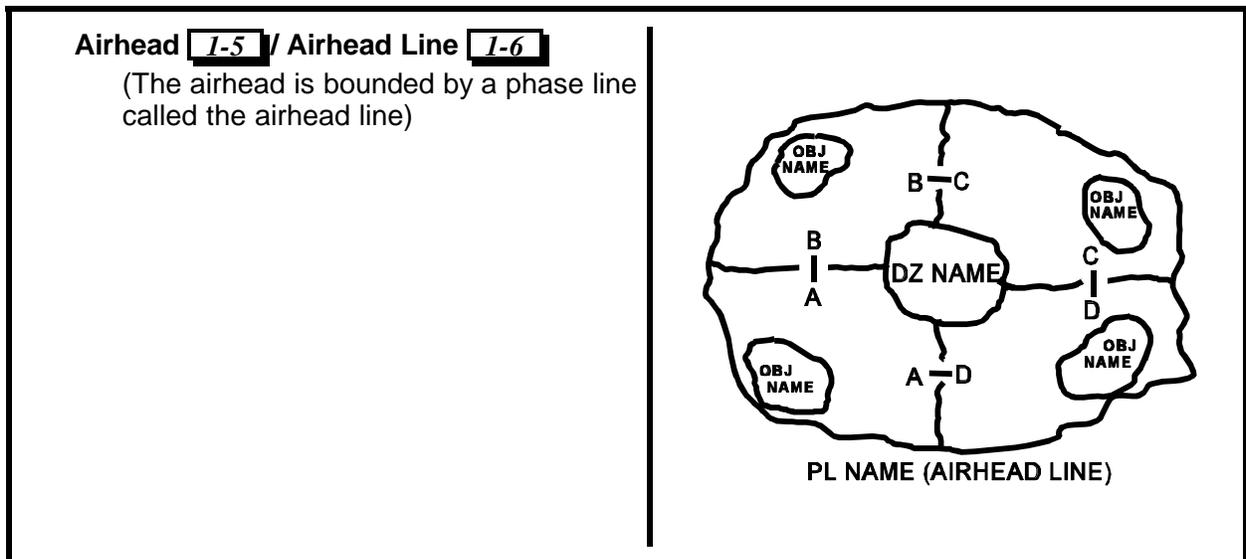

Maneuver-Special (Continued)

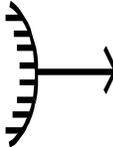
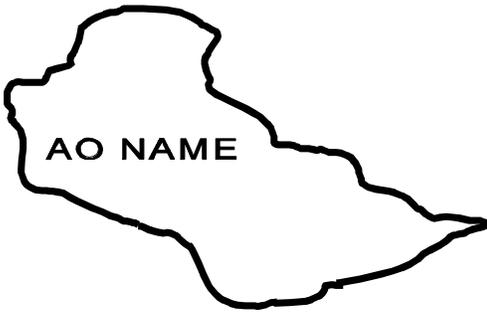
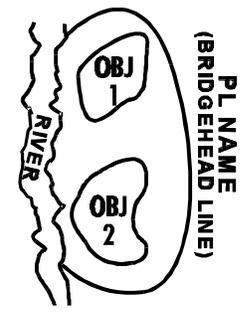
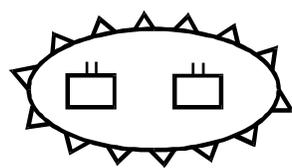
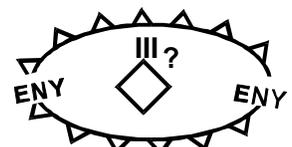
<p>Ambush 1-8</p> <p>(The base of the arrow shaft is the center of mass of the ambush unit's position, the arrow points in the direction of fire from the ambush unit.)</p>	
<p>Area of Operations (AO) 1-10</p>	
<p>Bridgehead 1-22</p> <p>(The bridgehead is bounded by a phase line called the bridgehead line.)</p>	
<p>Encirclement 1-60</p> <p>Friendly</p>	
<p>Enemy</p>	

OPERATIONAL TERMS AND GRAPHICS

Maneuver-Special (Continued)

<p>Holding Line I-78</p>	
<p>Named Area of Interest (NAI) I-107</p> <p>Point of Interest</p>	
<p>Release Line (RL) I-132</p>	
<p>Targeted Area of Interest (TAI) I-152</p> <p>Point of Interest</p>	

OPERATIONAL TERMS AND GRAPHICS

Maneuver and Fire (Continued)

<p>No Fire Line (NFL) I-109</p>	
<p>Restrictive Fire Area (RFA) I-133</p>	
<p>Restrictive Fire Line (RFL) I-133</p>	

FIRE SUPPORT

<p>Area Target I-151</p>	
<p>Bomb Area</p>	

Fire Support (Continued)

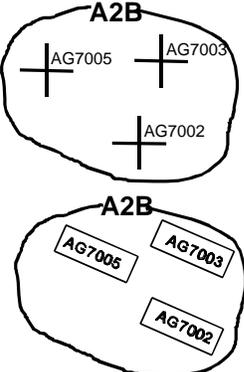
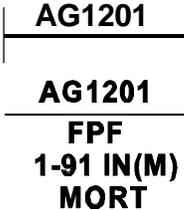
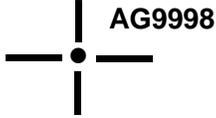
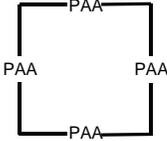
<p>Fire Support Area (FSA) I-67 (A sea area for naval gunfire support)</p>	
<p>Fire Support Station (FSS) I-67</p>	
<p>Group of Targets I-74 All targets are fired at the same time.</p> <p>Group of Targets Using Regular Targets</p> <p>Group of Targets Using Rectangular Targets</p>	
<p>Linear Target Final Protective Fire I-65 (The indirect fire unit designated to fire the FPF is listed below the target)</p>	
<p>Nuclear Target</p>	
<p>Position Area for Artillery (PAA) I-122 Paladin 2 km by 2 km MLRS 3 km by 3 km</p>	

OPERATIONAL TERMS AND GRAPHICS

Fire Support (Continued)

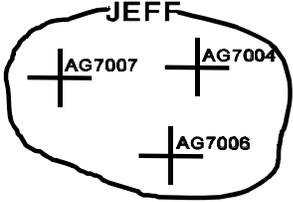
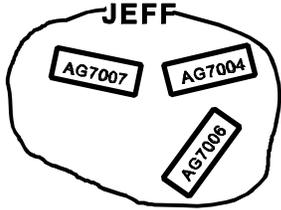
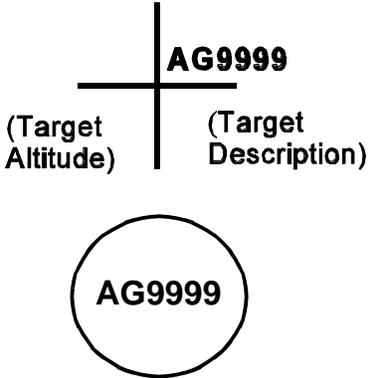
<p>Series of Targets 1-139</p> <p>Targets are fired in a predetermined sequence, for example, AG700, AG7006, and AG7004.</p> <p>Series of Targets Using Regular Targets</p> <p>Series of Targets Using Rectangular Targets</p>	 
<p>Smoke 1-111 1-125 1-141</p> <p>(Planned with designated time shown)</p> <p>(Actually in place)</p> <p>Linear Smoke Target</p>	  
<p>Target 1-151</p> <p>Target, Circular</p>	

COMMAND AND CONTROL

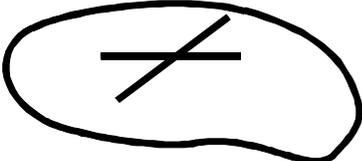
<p>Airfield Zone</p>	
<p>Checkpoint (CKP) I-25 (Bottom point or an extension is exact location.)</p>	
<p>Contact Point I-37</p>	
<p>Coordinating Point I-39 (Center of symbol is exact location.)</p>	
<p>Decision Point I-45</p>	
<p>General or Unspecified Point (Bottom point or an extension is exact location.)</p>	

OPERATIONAL TERMS AND GRAPHICS

Command and Control (Continued)

<p>Light Line (LL) I-91</p>	
<p>Linkup Point I-92</p>	
<p>Passage Point (PP) I-118</p>	
<p>Phase Line (PL) I-121</p>	
<p>Rally Point I-127</p>	
<p>Release Point I-132</p>	
<p>Start Point I-144</p>	
<p>Way Point I-162</p>	

MOBILITY AND SURVIVABILITY

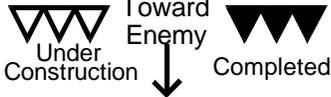
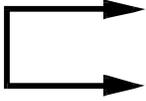
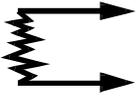
<p>Abatis I-1</p>	
<p>Antitank Obstacles Antitank Ditch</p>	
<p>Antitank Ditch Reinforced with Antitank Mines</p>	
<p>Antitank Obstacles, Tetrahedrons, Dragon's Teeth, and other similar obstacles</p>	<p>Fixed and Prefabricated </p> <p>Movable </p> <p>Movable and Prefabricated </p>
<p>Antitank Wall</p>	
<p>Booby Trap I-20</p>	
<p>Bypass I-23 Bypass Easy</p>	
<p>Bypass Difficult</p>	
<p>Bypass Impossible</p>	

Mobility and Survivability (Continued)

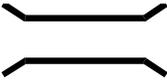
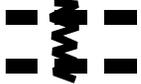
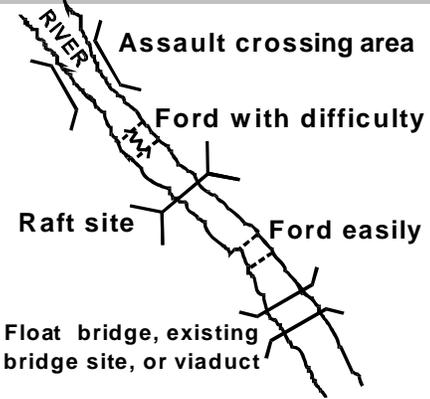
<p>Crossing Sites/Water Crossings Assault Crossing Area I-43</p>	
<p>Bridge or Gap I-72</p>	
<p>Ferry</p>	
<p>Ford/Ford Easy I-69</p>	
<p>Ford Difficult</p>	
<p>Lane I-89</p>	
<p>Raft Site</p>	
<p>Example Crossing Sites I-43</p>	
<p>Engineer Regulating Point I-61</p>	

Mobility and Survivability (Continued)

<p>General Obstacle</p> <p>Obstacle Belt I-112 (Controlled by 3d Brigade, 27th AD)</p> <hr/> <p>Obstacle Line I-112</p> <hr/> <p>Obstacle Zone I-112 (Controlled by 27th AD)</p>	 <hr/>  <hr/> 
<p>Mines</p> <p>Antipersonnel (AP) Mine</p> <hr/> <p>Antitank (AT) Mine</p> <hr/> <p>Antitank Mine with Antihandling Device</p> <hr/> <p>Directional Mine (Arrow Shows Effects) "Claymore Type Mine"</p> <hr/> <p>Unspecified Mine</p> <hr/> <p>Mine Cluster</p> <hr/> <p>Wide Area Mine</p>	 <hr/>  <hr/>  <hr/>  <hr/>  <hr/>  <hr/> 

OPERATIONAL TERMS AND GRAPHICS

Mobility and Survivability (Continued)

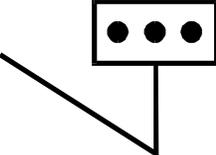
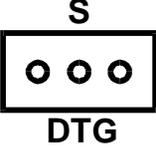
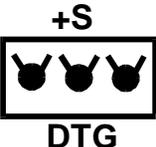
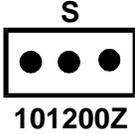
<p>Minefields 1-101 Planned Minefield (Unspecified mines)</p>	
<p>Completed Minefield (Unspecified mines)</p>	
<p>Antipersonnel (AP) Minefield</p>	
<p>Antitank (AT) Minefield with Gap (Show effective time and name of gap.)</p>	
<p>Antitank (AT) Minefield (Line points to center of mass of minefield)</p>	
<p>Scatterable Minefield (Unspecified mines) with Self-Destruct Date-Time Group 1-136</p>	
<p>Antipersonnel (AP) Minefield Reinforced with Scatterable with Self-Destruct Date-Time Group</p>	
<p>Scatterable Minefield (Antitank mines) with Self-Destruct Date-Time Group 1-136</p>	

OPERATIONAL TERMS AND GRAPHICS

Mobility and Survivability (Continued)

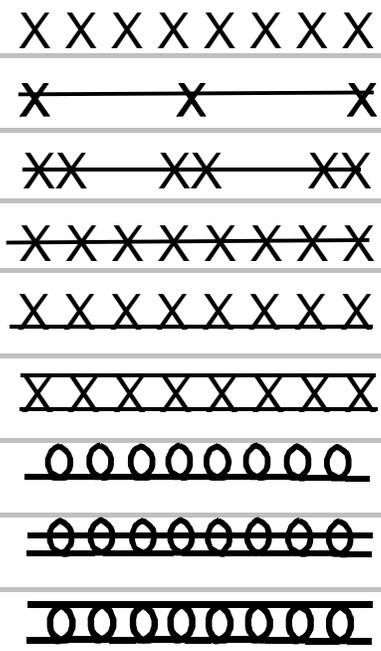
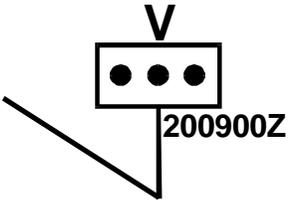
<p>Roadblock (Continued) Explosives, State of Readiness 2 (Armed but passable)</p>	
<p>Roadblock Complete (Executed)</p>	
<p>Wire Obstacles</p> <p>Unspecified</p> <p>Single Fence</p> <p>Double Fence</p> <p>Double Apron Fence</p> <p>Low Wire Fence</p> <p>High Wire Fence</p> <p>Single Concertina</p> <p>Double Strand Concertina</p> <p>Triple Strand Concertina</p>	
<p>Executed Volcano Minefield (The date-time group indicates the self-destruct time; the line indicates the center of mass of the Volcano minefield.)</p>	

Mobility and Survivability (Continued)

<p>Trip Wire</p>	
<p>Unexploded Ordnance (UXO) Area I-158</p>	

SURVIVABILITY

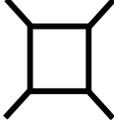
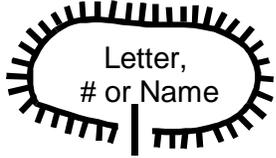
<p>Earthwork, Small Trench, or Fortification (Line points to exact location.) I-65</p>	
<p>Fort</p>	
<p>Fortified Line</p>	
<p>Foxhole, Emplacement I-60, or Weapon Slit</p>	
<p>Strong Point I-146 (Company-sized) (Size indicator faces away from anticipated enemy direction; it is equally fortified on all sides.)</p>	
<p>Surface Shelter Line points to exact location.)</p>	
<p>Underground Shelter (Line points to exact location.)</p>	

OPERATIONAL TERMS AND GRAPHICS

Survivability-Nuclear, Biological, Chemical (NBC)

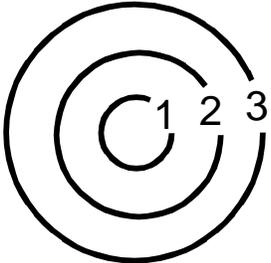
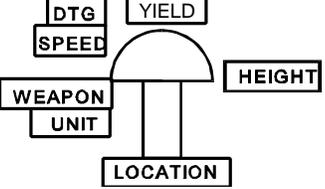
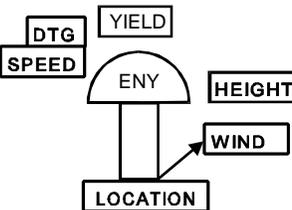
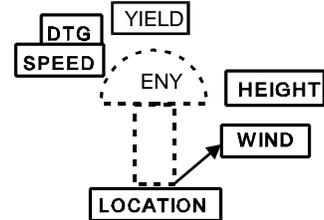
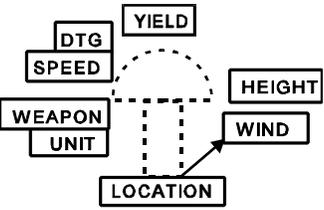
<p>Minimum Safe Distance Zones <u>1-101</u></p> <p>(Shows minimum safe distance (MSD) from ground zero of a friendly nuclear explosion as zones 1, 2, and 3.)</p>	
<p>Nuclear Detonations, Releases, or Events Friendly Ground Zero</p> <p>Note: Height stated in meters or as high, low, surface, or subsurface.</p>	
<p>Enemy Known, Ground Zero</p>	
<p>Enemy Templated</p>	
<p>Friendly Planned or On order</p>	
<p>Fallout Producing</p>	

Survivability-Nuclear, Biological, Chemical (NBC)(Continued)

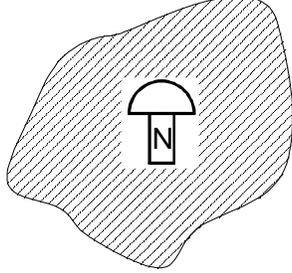
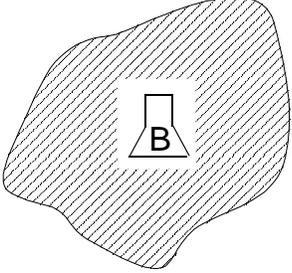
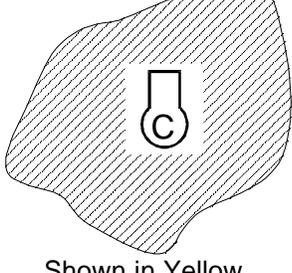
<p>Biological and Chemical Attack Release Events</p>	
<p>Contaminated Areas Radioactive Area (Used to show the limits of the nuclear contamination. A dose rate contour line overlay should be used if entering the area.)</p>	 <p>Shown in Yellow (If Available)</p>
<p>Biologically Contaminated Area</p>	 <p>Shown in Yellow (If Available)</p>
<p>Chemically Contaminated Area</p>	 <p>Shown in Yellow (If Available)</p>

OPERATIONAL TERMS AND GRAPHICS

Survivability-Nuclear, Biological, Chemical (NBC)(Continued)

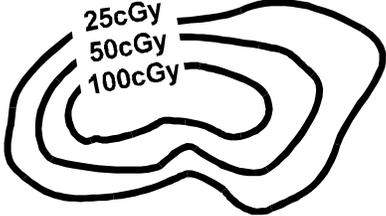
<p>NBC (Continued) Decontamination I-46 Points Decon Site/Point (Unspecified)</p>	
<p>Alternate Decon Site/Point (Unspecified)</p>	
<p>Decon Site/Point (Troops) I-52</p>	
<p>Decon Site/ Point (Equipment) I-52</p>	
<p>Decon Site/Point (Equipment and troops) I-52</p>	
<p>Decon Site/Point (Operational decontamination)</p>	
<p>Decon Site/Point (Thorough decontamination)</p>	
<p>Dose Rate Contour Lines I-56 Levels of radioactivity are represented in centigrays per hour. The overlay is drawn to the scale of the map and from survey (reconnaissance) data.</p>	

COMBAT SERVICE SUPPORT

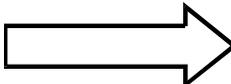
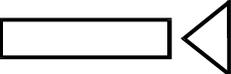
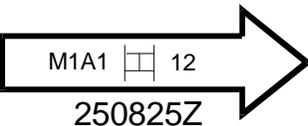
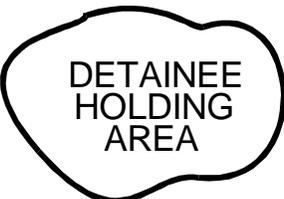
Ambulance Exchange Point I-8 (Point # 3 serviced by 2d Bde)	
Ammunition Points: ASP I-8 ATP I-8	
Cannibalization Point I-24	
Casualty Collection Point (CCP) I-24	
Civilian Collection Point	
Convoys I-39 Moving Convoy	
Halted Convoy	
A Column of 12 Medium Tanks at 0825 on the 25th	
Detainee Holding Area I-52	

OPERATIONAL TERMS AND GRAPHICS

Combat Service Support (Continued)

<p>Detainee Collection Point I-52</p>	 <p>DET</p>
<p>Enemy Prisoner of War (EPW) Collection Point I-60</p>	 <p>EPW</p>
<p>Enemy Prisoner of War (EPW) Holding Area I-60</p>	
<p>Forward Arming and Refueling Point (FARP) I-70</p>	
<p>Logistics Release Point (LRP) I-93</p>	 <p>LRP</p>
<p>Maintenance Collection Point I-96</p>	 <p>MCP</p>
<p>Refugee Holding Area</p>	
<p>Rearm, Refuel, and Resupply Point (R3P) I-129</p>	 <p>R3P</p>

Combat Service Support (Continued)

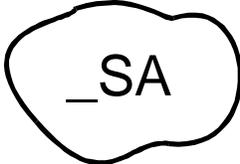
<p>Refuel on the Move (ROM) Point <u>I-131</u></p>	<p></p>
<p>Support Areas: Brigade (BSA) <u>I-22</u> Division (DSA) <u>I-55</u> Regimental (RSA)</p>	<p></p>
<p>Supply Points <u>I-27</u> <u>I-147</u> General (For multiple classes of supplies, show outside upper right.)</p>	<p> </p>
<p>Class I</p>	<p></p>
<p>Class II</p>	<p></p>
<p>Class III</p>	<p></p>
<p>Class IV</p>	<p></p>
<p>Class V</p>	<p></p>
<p>Class VI</p>	<p></p>
<p>Class VII</p>	<p></p>

OPERATIONAL TERMS AND GRAPHICS

Combat Service Support (Continued)

<p>Supply Points (Continued) Class VIII</p> <hr/> <p>Class IX</p> <hr/> <p>Class X</p>	  
<p>Supply Routes 1-95 Main Supply Route</p> <hr/> <p>Alternate Supply Route 1-8</p> <hr/> <p>One-way Traffic</p> <hr/> <p>Alternating Traffic</p> <hr/> <p>Two-way Traffic</p>	<p>MSR NAME</p>  <p>ASR NAME</p>  <p>MSR NAME</p>  <p>MSR NAME ← ALT →</p>  <p>MSR NAME</p> 
<p>Traffic Control Post (TCP) 1-156</p>	
<p>Trailer Transfer Point (TTP) 1-156</p>	
<p>Unit Maintenance Collection Point (UMCP) 1-159</p>	

Chapter 4 Unit Symbols

The shadowed boxes **1-16** show the page number for the definition of a symbol.

This chapter establishes a standard system for the development of ground unit symbols. These symbols are for use on situation maps, overlays, and annotated aerial photographs. This chapter applies to both automated and hand-drawn graphic displays or overlays.

This chapter includes a wide variety of unit symbols as well as modifiers for building new or unique symbols. Users should avoid using any symbols, or combinations and modifications of symbols, that differ from those in this manual. If the user, after searching doctrinal symbols and modifiers, must create a new symbol, it must be explained in an accompanying legend.

The symbols shown in this chapter are adequate for depicting enemy units. When representing unorthodox units and equipment, select the most appropriate symbol contained herein.

ICON-BASED SYMBOLS

A symbol is composed of three components: a frame (geometric border), fill, and icon. Frames are geometric shapes used to display affiliation. Affiliation refers to whether the warfighting object being represented is a threat. The basic affiliation categories are friendly, unknown, neutral, and enemy. The unknown frame shape is normally used only for aircraft and ships. The frame shape for suspected friendly, enemy, or neutral is used for ground units not positively identified. The basic frame shapes for units, installations, activities, and logistics sites are shown in Figure 4-1, page 4-2.

OPERATIONAL TERMS AND GRAPHICS

	Friendly Ground Units	Friendly Sea/Air	Unknown Sea/Air	Neutral	Enemy Units
Surface					
Subsurface					
In-flight					

Figure 4-1. Unit, Installation, and Site Symbol Frames

Fill refers to the area within the frame. If color is used in a symbol, it shall indicate affiliation. Generally, black is used for the frame, icon, and modifiers when symbols are displayed on a light background. White is used for these elements when they are displayed on a dark background. A color fill can be used if an icon is displayed within the area of the frame. Figure 4-2, from MILSTD 2525A, shows the color defaults for affiliation used for hand-drawn and computer-generated symbols. The use of any other colors must be explained in an accompanying legend. Automated systems allow users to select other colors and to portray their meaning on the automated overlay display.

Affiliation	Hand-Drawn	Computer-Generated
Friend, Assumed Friend	Blue	Cyan
Unknown, Pending	Yellow	Yellow
Neutral	Green	Green
Enemy, Suspect, Joker, Faker	Red	Red

Figure 4-2. Color Defaults

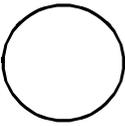
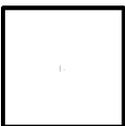
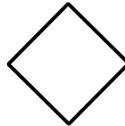
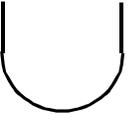
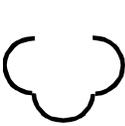
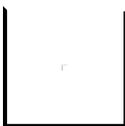
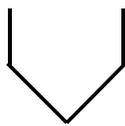
The icon is a “role indicator” that shows the warfighting function the unit performs either on the ground, in the air, or at sea. An example is the crossed rifles which represent an infantry unit.

This manual does not include an example of every type of unit; however, users can see from those presented the pattern of construction in order to make symbols for new or unique units. Upon US Army and Marine Corps approval, MILSTD 2525A, *Common Warfighting Symbolology*, will contain more approved ground unit symbols. Appendix A includes additional examples of friendly units. Appendix B includes examples of enemy units.

BUILDING UNIT SYMBOLS

Seven rules govern the building of unit symbols. They are:

1. Existing standard symbols must be used whenever possible as building blocks for new symbols.
2. Symbols must be usable in manual as well as automated modes.
3. Symbols must be easily distinguishable.
4. Friendly symbols must not use attributes that could be confused with enemy symbols.
5. Symbols must be distinguishable without color. (Monochrome display.)
6. Composite symbols will generally have the primary symbol centered on or below the modifying symbols.
7. All unit symbols will be drawn or portrayed with the top of the symbol facing the top of the overlay (normally North is at the top). Orientation of the symbol will be accomplished by using the "Q" field for moving symbols or another graphic such as a battle position or support by fire position.

Normally, additional information needs to be included with the unit symbol and is placed in standardized unit labeling fields shown in Figure 4-3. The fields are defined in Figure 4-4. The unit location is determined by the center of mass of the symbol or a line (without an arrow head) from the center of the bottom of the frame to the location. Headquarters unit locations are at the bottom of the "headquarters staff," displayed as field "S."

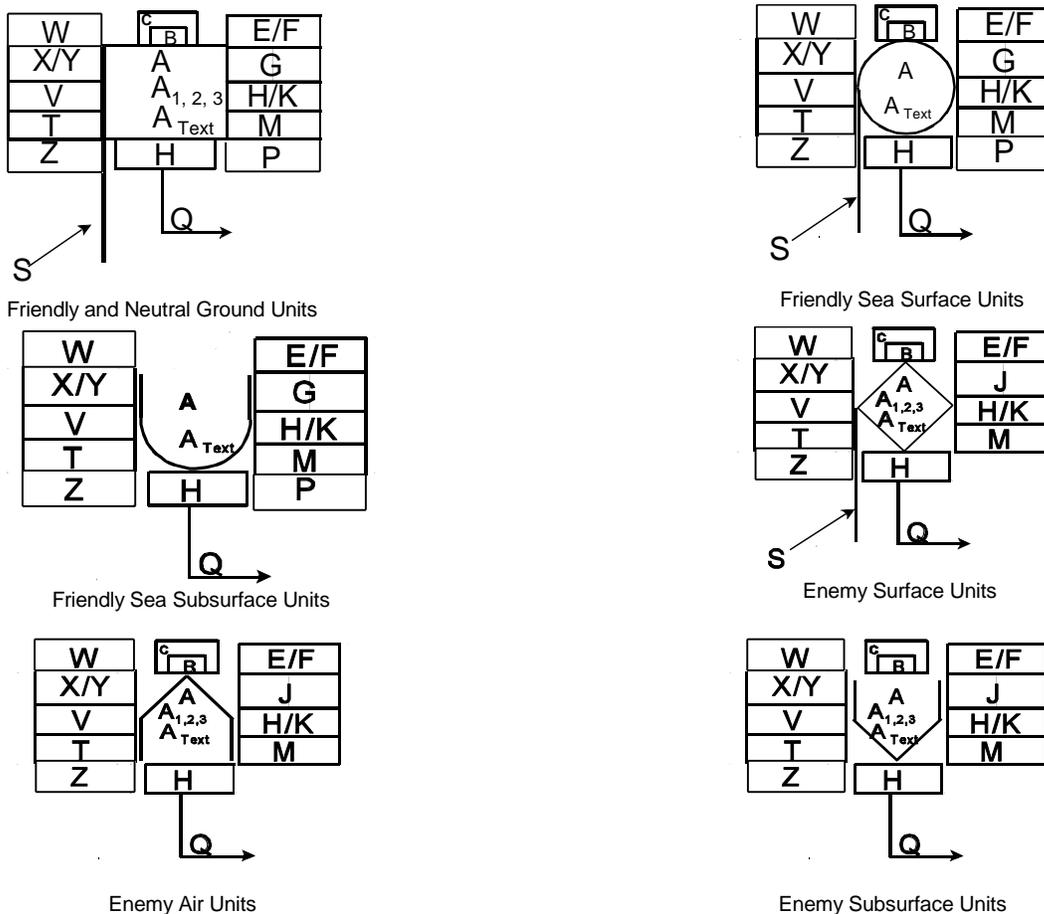

Figure 4-3. Standardized Unit Labeling Fields

OPERATIONAL TERMS AND GRAPHICS

Field	Field Title	Description	Application	Length (characters)
A	Symbol	Frame, fill, and icon showing basic function of units, installations, or equipment with modifiers A1,A2, and A3.	All	
B	Size Indicator	A symbol that denotes the size of a unit or installation (see Figure 4-5).	Units and installations	
C	Equipment	Indicates number of items present. Installation: Size in square feet.	Units and installations	10
D	Task Force	A symbol placed over the size indicator to denote a task force or company team (see Figure 4-3).	Units	6
E	Suspect, Assumed Friend, Faker, Joker	Question mark ' ? ' : suspect, assumed friend, faker. ' J ' : Joker.	All	1
F	Reinforced or Detached	Shows (+) reinforced , (-) reduced, or (+-) reinforced and reduced.	Units	3
G	Staff Comments	Free text.	All	20
H	Additional Information	Free text.	All	20
J	Evaluation Rating	One letter and one number (see STANAG 2022).	Enemy only	2
K	Combat Effectiveness	Effectiveness of unit displayed.	Units and installations	5
L	Signature Equipment	Indicated by "I" (refers to detectable electronic signatures).	Enemy equipment only	1
M	Higher Formation	Number or title of higher echelon command (corps designated by Roman numerals).	All	21
N	Enemy (Hostile)	Indicated enemy by letters "ENY."	Enemy equipment, lines, areas, and boundaries	3
P	IFF/SIF	Identification modes and codes.	Units and equipment	5
Q	Direction of Movement Arrow	Direction symbol is moving or will move. Nuclear, biological, chemical: Downwind direction.	All	4
R	Mobility Indicator	Pictorial representation of mobility.	Equipment only	
S	Headquarters Staff Indicator/Locating Indicator	Identifies unit symbol as a headquarters or used to indicate location or to declutter.	Units	
T	Unique Designation	An alphanumeric title that uniquely identifies a particular symbol; track number. Nuclear: Friendly delivery unit (missile, satellite, aircraft, etc).	All	21
V	Type of Equipment	Identifies unique designation. Nuclear: Friendly weapons type.	Units and equipment	24
W	Date-Time Group	Alphanumeric field for date/time (MILSTD-2500A) (DDHHMMSSZMONYY) or " o/o" for on order.	All	15
X	Altitude/Depth	Altitude portion of GPS. Flight level for aircraft. Depth for submerged objects. Height in feet of equipment or structure on the ground. Nuclear: Height of burst.	All	6
Y	Location	Latitude and longitude ; grid coordinates.	All	19
Z	Speed	Nautical miles per hour; kilometers per hour.	Units and equipment	5

Figure 4-4. Labeling Field Definitions

As an example, we will build the symbol for a friendly nuclear, biological, or chemical (NBC) reconnaissance unit equipped with the FOX and M21 long-range sensor.

STEP 1. First choose the frame (friendly) and graphic for the basic function or branch of the unit, labeling field “A,” In this example, the basic function is NBC.



STEP 2. Choose the graphic modifier for the secondary function or capability, labeling field “A₁” (possibly from the list of modifiers). In this example, the secondary function and first modifier is reconnaissance.



STEP 3. Choose the graphic modifier for the next capability, labeling field “A₂.” In this example, the tertiary (third function or capability) is wheeled armored vehicle.

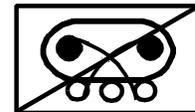

STEP 4. Choose the graphic modifier for any other capability, labeling field “A₃.” This example requires no more graphic modifiers.

STEP 5. If necessary to fully distinguish the unit from another type of unit, include a text abbreviation, labeling field “A_{TEXT},” inside the symbol frame. In this example, a text abbreviation “RS” is added inside the symbol to show that this unit is specially equipped with the M21 sensor. Unit size indicators, shown in Figure 4-5, are placed at the top center of the symbol frame in field “B.”

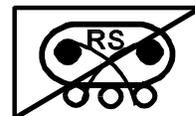

Size Indicator	Meaning
■	Installation
∅	Team/Crew
●	Squad
● ●	Section
● ● ●	Platoon/Detachment
I	Company/Battery/Troop
II	Battalion/Squadron
III	Regiment/Group
X	Brigade
X X	Division
X X X	Corps
X X X X	Army
X X X X X	Army Group/Front
X X X X X X	Region

Figure 4-5. Unit Size and Installation Indicator

OPERATIONAL TERMS AND GRAPHICS

Figure 4-6 shows the abbreviations used when identifying units or marking boundaries.

Long Name	Abbreviation
Air Assault	AASLT
Airborne	ABN
Armored Cavalry Regiment	ACR
Armored Division	AD
Cavalry Division	CAV
Infantry Division	ID
Light Infantry Division	ID(L)
Mechanized Battalion or TF	MECH
Mechanized Infantry Division	ID(M)
Mountain	MTN
Separate Armored Brigade	SAB
Separate Infantry Brigade	SIB
Separate Infantry Brigade (Light)	SIB(L)
Separate Infantry Brigade (Mechanized)	SIB(M)

Figure 4-6. Unit Abbreviations

SYMBOLS FOR THE GROUND ENVIRONMENT

Situation maps and overlays provide a rapid and easily understood means by which a commander or staff may express an operational plan, concept, or friendly or enemy situation. The combination of unit and weapon symbols with objectives, boundaries, routes of march, and other control measures creates an indispensable tool for quickly and accurately portraying battle activity. Standardization of techniques is essential if tactical information is to be relayed without misunderstanding.

Present and Proposed Locations

Basic unit and installation symbols are drawn with either solid or broken lines. The center of mass of the symbol indicates the general vicinity of the center of mass of the unit. If a staff is added to identify a headquarters, the base of the staff indicates the precise location of the headquarters.

A solid line symbol represents a present or actual location.	
A broken line symbol indicates a future or projected location.	

Precise Locations

To indicate locations more precisely, the following methods are employed.

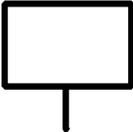
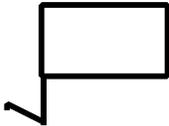
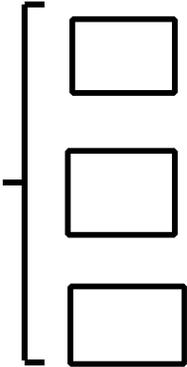
<p>Basic symbols other than the headquarters symbol (for example, points) may be placed on a staff which is extended or bent. The end of the staff indicates the precise location.</p>	
<p>Since the headquarters symbol already includes a staff, this staff may be extended or bent. The end of the staff, or extension (if used), indicates the exact location of the headquarters.</p>	
<p>If several headquarters are at one location, more than one headquarters symbol can be on a single staff.</p>	
<p>If a group of units or installations other than a headquarters is at one location, the grouping of symbols may be enclosed with a bracket and the exact location indicated with a staff.</p>	

UNIT SYMBOL MODIFIERS

Unit symbol modifiers are combined with basic unit function (branch) symbols to create a composite symbol that represents a unique type of unit. All modifiers are placed in either the center of the frame, upper half, or above the basic function symbol with the exception of airborne, mountain, and light modifiers. These are placed below the basic function symbol. In addition to the modifier symbols, text may be used inside the symbol frame to further clarify the symbol.

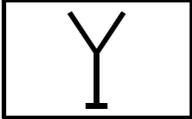
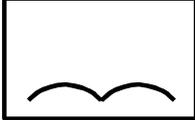
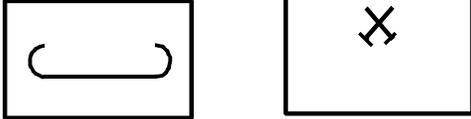
Air Assault 7-4	
Air Assault w/Organic Lift	
Air Assault w/Organic Lift (NATO Only)	
Airborne 7-4	
Amphibious-Naval 7-8	
Arctic-Ski	
Bicycle-Equipped	

Unit Symbol Modifiers (Continued)

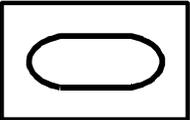
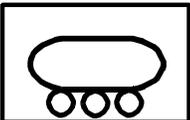
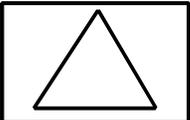
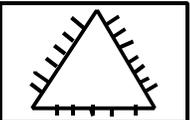
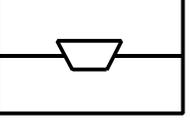
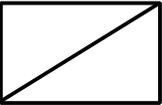
<p>Gun System-Equipped (Vulcan, IFV, ZSU, etc.)</p>	
<p>Horse, Camel, or Pack Animal-Equipped</p>	
<p>Mechanized or Armored (Tracked or Wheeled)</p>	<div style="display: flex; justify-content: space-around; align-items: center;"> <div style="text-align: center;">  <p>Tracked</p> </div> <div style="text-align: center;">  <p>Wheeled</p> </div> </div>
<p>Motorized</p>	
<p>Mountain</p>	
<p>Observation or Listening Posts— Combat Outpost 7-37</p>	<div style="display: flex; justify-content: space-around; align-items: center;"> <div style="text-align: center;">  </div> <div style="text-align: center;">  </div> </div>
<p>Radar—Sensor 7-139</p>	<div style="display: flex; justify-content: space-around; align-items: center;"> <div style="text-align: center;">  </div> <div style="text-align: center;">  </div> </div>
<p>Reconnaissance 7-130</p>	
<p>Riverine or Floating</p>	

OPERATIONAL TERMS AND GRAPHICS

COMBAT ARMS

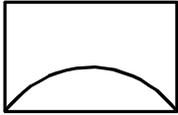
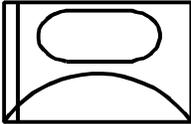
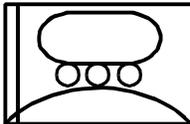
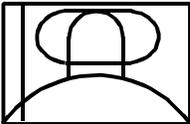
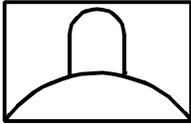
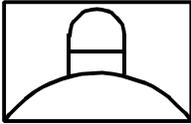
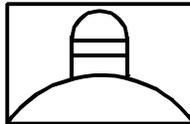
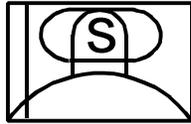
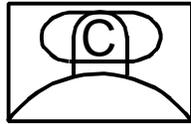
<p>Air Defense Artillery Air Defense I-5</p>	
<p>Generic Gun System-Equipped</p>	   <p>Towed Tracked & Armored Wheeled & Armored</p>
<p>Generic Gun and Missile, Tracked, Armored System-Equipped Unit</p>	
<p>Generic Missile (Low, medium, and high altitude) (Short, medium, and long range)</p>	  
<p>Radar (Target acquisition or tracking)</p>	
<p>Avenger (Motorized missile system)</p>	
<p>Bradley Stinger (Tracked gun/missile combination)</p>	
<p>Chaparral</p>	

Combat Arms (Continued)

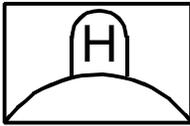
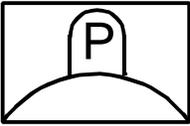
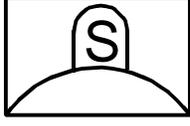
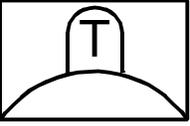
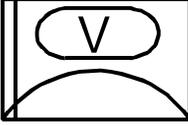
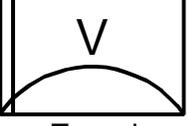
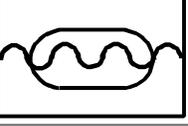
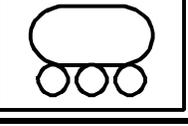
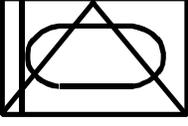
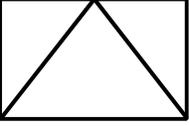
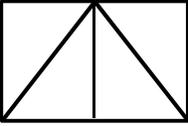
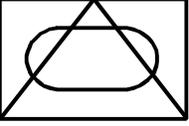
<p>Air Defense Artillery (Continued) Hawk</p>	
<p>Patriot</p>	
<p>Stinger or Short Range/Low Altitude Missile</p>	
<p>Theater Missile Defense I-154</p>	
<p>Vulcan (Gun system)</p>	  <p>M113 (tracked) Towed</p>
<p>Armor Tracked Tank-Equipped</p>	
<p>Assault Amphibious Vehicle (AAV) (US) Amphibious Tank</p>	
<p>Wheeled Tank-Equipped</p>	
<p>Antiarmor</p>	    <p>Fighting Vehicle Dismounted Motorized Mechanized</p>

OPERATIONAL TERMS AND GRAPHICS

Combat Arms (Continued)

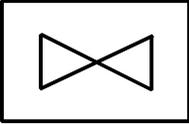
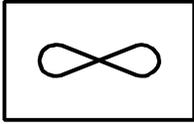
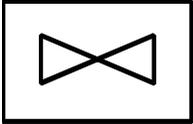
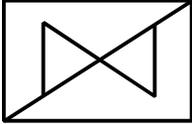
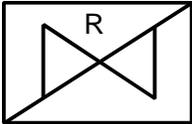
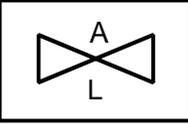
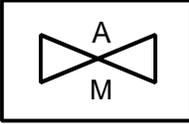
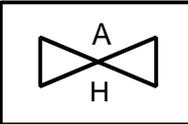
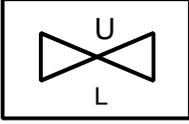
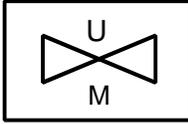
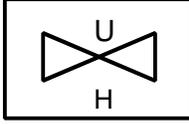
<p>Aviation Aviation (Basic)</p>			
<p>Fixed Wing</p>			
<p>Rotary Wing (Basic)</p>			
<p>Air Cavalry</p>			
<p>Reconnaissance (Scout) Helicopter (OH-58)</p>			
<p>Attack Helicopter</p>			
<p>Lift Helicopter</p>			

Combat Arms (Continued)

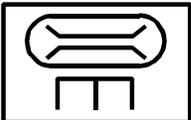
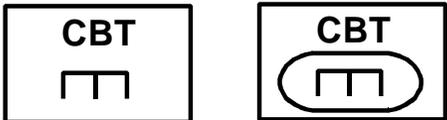
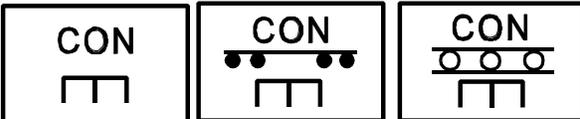
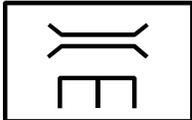
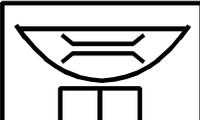
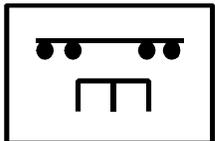
<p>Engineer</p> <p>Engineer (Basic)</p>	
<p>Armored Vehicle-Launched Bridge (AVLB)</p>	
<p>Combat (Dismounted and mechanized)</p>	
<p>Construction (General, railway, pipeline)</p>	
<p>Engineer Bridge</p>	
<p>Floating Bridge</p>	
<p>Railway Operating Unit</p>	

OPERATIONAL TERMS AND GRAPHICS

Combat Arms (Continued)

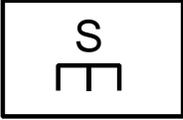
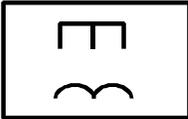
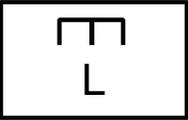
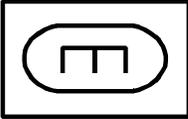
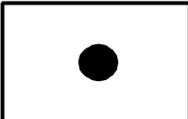
Scatterable Mine-Laying Unit	
Topographic	
Air Assault Engineers	
Airborne Engineers	
Light Engineers	
Mechanized Engineers	
Field Artillery	
Field Artillery (Basic) (Towed)	
Artillery Locating Radar Target Acquisition Radar	

Combat Arms (Continued)

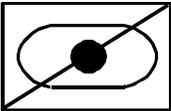
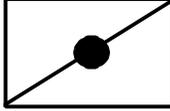
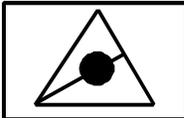
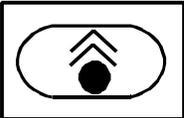
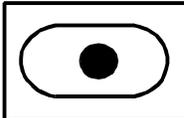
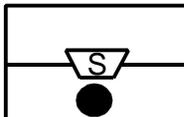
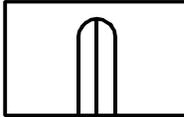
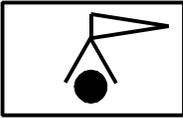
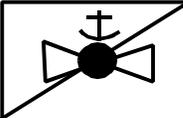
Field Artillery (Continued)	
COLT I-31 or FIST I-67	  Tracked Dismounted
Forward Observer Position	
Rocket Artillery (MLRS or ATACMS)	
Self-propelled (SP) Artillery	
Sound Ranging (Target acquisition)	
Surface-to-Surface Missile	
Survey	
Air/Naval Gunfire Liaison Company (ANGLICO) I-6	

OPERATIONAL TERMS AND GRAPHICS

Combat Arms (Continued)

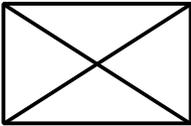
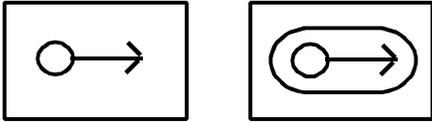
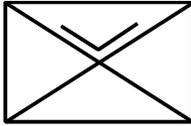
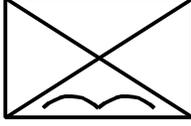
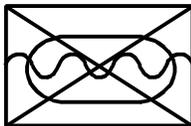
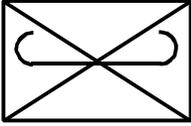
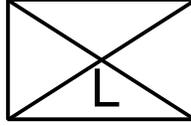
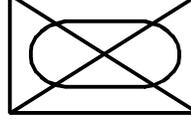
<p>Infantry Infantry (Basic)</p>	
<p>Mortar</p>	
<p>Air Assault I-4 Infantry</p>	
<p>Airborne I-4 Infantry</p>	
<p>Amphibious Infantry (USMC landing teams)—Naval Infantry</p>	
<p>Arctic Infantry</p>	
<p>Light Infantry</p>	
<p>Mechanized Infantry (In tracked armored personnel carrier (APC))</p>	

Combat Arms (Continued)

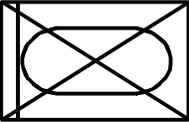
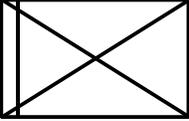
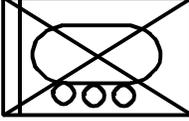
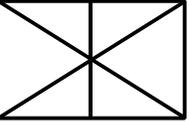
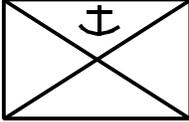
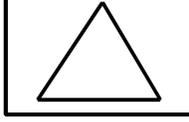
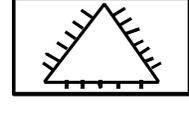
<p>Infantry (Continued) Mechanized Infantry (In tracked infantry fighting vehicle (IFV) (Bradley, Marder, BMP, etc))</p>	
<p>Mechanized Infantry (Dismounted from a tracked infantry fighting vehicle (IFV) (Bradley, Marder, BMP, etc))</p>	
<p>Mechanized Infantry (In wheeled infantry fighting vehicle (IFV)) (Marine light armored infantry (LAI))</p>	
<p>Motorized Infantry (Equipped with unarmored but armed wheeled vehicles) (HMMWVs with MK19s or .50-caliber machine guns)</p>	
<p>Mountain Infantry</p>	
<p>Naval Infantry</p>	
<p>Observation Post/Outpost 1-112</p>	
<p>Combat Outpost 1-31</p>	

OPERATIONAL TERMS AND GRAPHICS

Combat Arms (Continued)

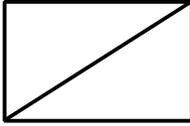
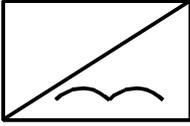
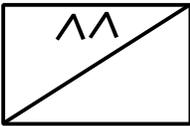
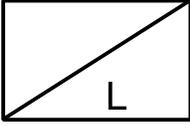
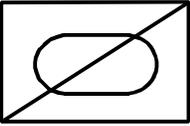
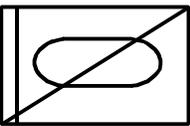
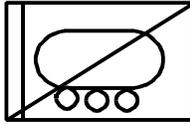
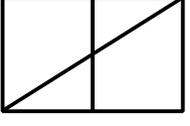
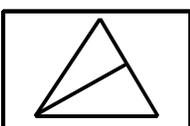
<p>Reconnaissance 1-130 Reconnaissance, Cavalry, or Scouts (Basic or dismounted)</p>	
<p>Airborne Cavalry, Reconnaissance, or Scouts</p>	
<p>Horse Cavalry, Reconnaissance, or Scouts</p>	
<p>Light Cavalry, Reconnaissance, or Scouts</p>	
<p>Armored (APC) Cavalry, Reconnaissance, or Scouts</p>	
<p>Armored (Tracked IFV) Cavalry, Reconnaissance, or Scouts</p>	
<p>Armored (Wheeled IFV) Reconnaissance or Scouts (Marine light armored reconnaissance (LAR))</p>	
<p>Motorized (HMMWV or BRDM) Reconnaissance or Scouts</p>	
<p>Observation Post Occupied by Dismounted Scouts or Reconnaissance</p>	

COMBAT SUPPORT

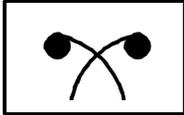
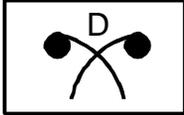
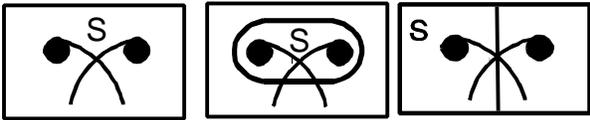
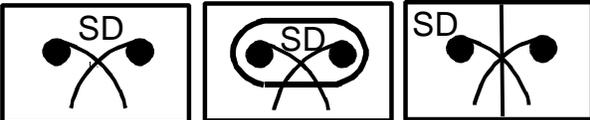
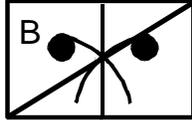
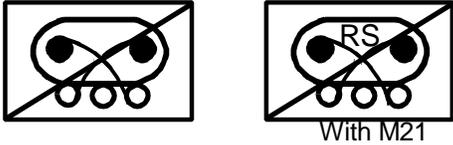
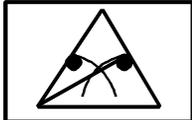
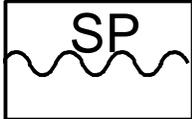
<p>Chemical Corps Nuclear, Biological, and Chemical (NBC) NBC (Basic symbol)</p>	
<p>Decontamination I-46</p>	
<p>Smoke (Basic or truck-equipped, APC-equipped, HMMWV-equipped)</p>	
<p>Smoke and Decontamination (Basic or Truck-equipped, APC-equipped, HMMWV-equipped)</p>	
<p>Biological Reconnaissance (HMMWV-equipped (BIDS))</p>	
<p>Chemical and Nuclear Reconnaissance (Wheeled Armored Vehicle (FOX))</p>	 <p style="text-align: right; margin-right: 50px;">With M21</p>
<p>NBC Observation Post (OP) (Dis-mounted)</p>	
<p>Landing Support Shore Party</p>	
<p>Military Intelligence Basic Symbol</p>	

OPERATIONAL TERMS AND GRAPHICS

Combat Support (Continued)

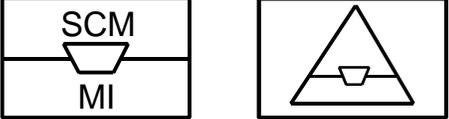
<p>Military Intelligence Aerial Exploitation (UAV)</p>	
<p>Ground Station Module for J-STARS</p>	
<p>Ground Surveillance Radar (GSR)</p>	
<p>Meteorological</p>	
<p>Military Intelligence Operations</p>	
<p>Sensor Control and Management (USMC (SCAMP))—Sensor OP/LP 1-139</p>	
<p>Tactical Exploitation Battalion</p>	
<p>Electronic Warfare (Basic symbol)— (USMC LAV-equipped EW unit) The following symbols replace the “site” symbols for EW.</p>	
<p>Direction Finding (Unit, crew, or installation)</p>	

Combat Support (Continued)

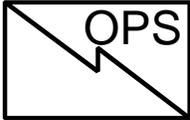
<p>Military Intelligence (Continued) EW Intercept (Unit, crew, or installation)</p> <hr style="border-top: 1px dashed black;"/> <p>EW Jamming (Unit, crew, or installation)</p>	 <hr style="border-top: 1px dashed black;"/> 
<p>Law Enforcement-Army Military Police</p>	
<p>Signal/Communications Basic Symbol</p> <hr/> <p>Area Signal</p> <hr/> <p>Command Operations</p> <hr/> <p>Construction/Installers</p> <hr/> <p>Forced Entry System</p> <hr/> <p>Forward Communications</p>	 <hr/>  <hr/>  <hr/>  <hr/>  <hr/> 

OPERATIONAL TERMS AND GRAPHICS

Combat Support (Continued)

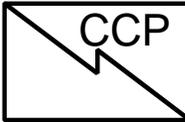
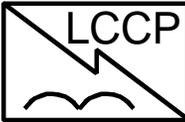
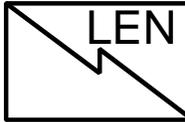
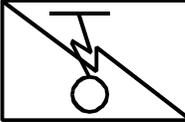
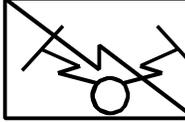
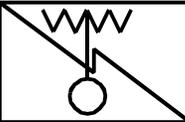
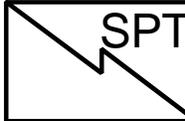
<p>Signal (Continued) Communications Configured Package (CCP); "Light" (LCCP) (Airborne)</p>		
<p>Multiple Subscriber Element (MSE)</p>		
<p>Large Extension Node (LEN)</p>		
<p>Node Center</p>		
<p>Remote Access Unit (RAU)</p>		
<p>Small Extension Node (SEN)</p>		
<p>Radio Relay Station--Retrans Station</p>		
<p>Radio/Wireless Station--Radio Recon OP</p>		
<p>Signal Support Operations</p>		

Combat Support (Continued)

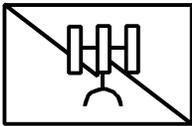
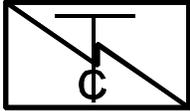
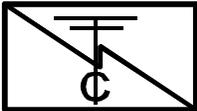
<p>Signal (Continued) Tactical Satellite Communications</p>	
<p>Telephone Switching Center</p>	
<p>Teletype Center</p>	

COMBAT SERVICE SUPPORT

Multifunctional Combat Service Support

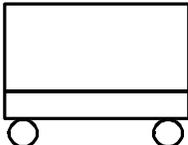
<p>Echelons Above Corps Combat Service Support</p>	
<p>Corps Level Combat Service Support</p>	
<p>Supply</p>	
<p>Supply Trains I-32</p>	

OPERATIONAL TERMS AND GRAPHICS

Multifunctional Combat Service Support (Continued)

The size indicator represents the rank or relative position of the commander of the CSS unit. The “M” labeling field will describe who the higher headquarters is that the CSS organization is supporting.

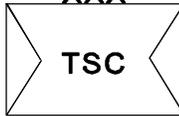
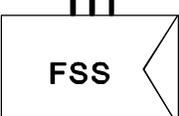
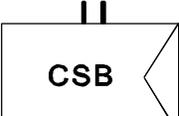
<p>Theater Army Area Command</p> <p>Theater Support Command</p>	<p style="text-align: center;">XX XXX</p> <div style="display: flex; justify-content: space-around; align-items: center;">   </div>
<p>Area Support Group</p>	<p style="text-align: center;">III</p> 
<p>Area Support Battalion I-II</p>	<p style="text-align: center;">II</p> 
<p>Corps Support Command (COSCOM)</p>	<p style="text-align: center;">XX</p> 
<p>Corps Support Group (Forward (F) and Rear (R))</p>	<p style="text-align: center;">III III</p> <div style="display: flex; justify-content: space-around; align-items: center;">   </div>
<p>Force Service Support Group (FSSG) (USMC)</p>	<p style="text-align: center;">III</p> 
<p>Corps Support Battalion</p>	<p style="text-align: center;">II</p> 
<p>Division Support Command (DISCOM)</p>	<p style="text-align: center;">X</p> 

Multifunctional Combat Service Support (Continued)

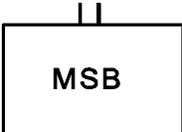
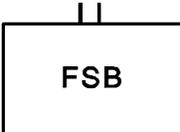
<p>Division Aviation Support Battalion</p>	
<p>Main Support Battalion</p>	
<p>Forward Support Battalion</p>	

Combat Service Support

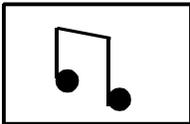
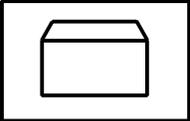
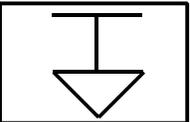
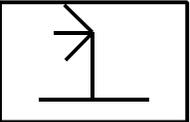
<p>Band</p>	
<p>Finance</p>	
<p>Labor</p>	
<p>Laundry and Bath</p>	
<p>Laundry, Shower, and Clothing Repair</p>	<p>LSCR</p>

OPERATIONAL TERMS AND GRAPHICS

Combat Service Support (Continued)

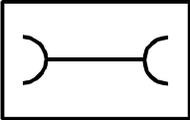
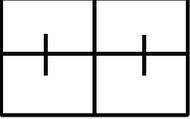
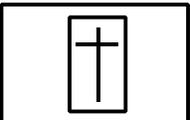
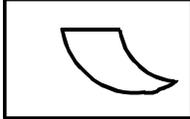
<p>Maintenance 1-95</p>	
<p>Medical Medical (Basic symbol)</p>	
<p>Medical Treatment Facility (MTF) 1-4 (BAS) 1-99</p>	
<p>Dental</p>	
<p>Veterinary</p>	
<p>Morale, Welfare, and Recreation (MWR)</p>	
<p>Mortuary Affairs 1-105</p>	
<p>Personnel Services</p>	
<p>Postal or Courier</p>	

Combat Service Support (Continued)

Public Affairs I-125	<div style="border: 1px solid black; width: 100px; height: 50px; display: flex; align-items: center; justify-content: center; margin: 0 auto;"> PA </div>
Broadcast Public Affairs Detachment	<div style="border: 1px solid black; width: 100px; height: 50px; display: flex; align-items: center; justify-content: center; margin: 0 auto;"> BPAD </div>
Corps Media Center	<div style="border: 1px solid black; width: 100px; height: 50px; display: flex; align-items: center; justify-content: center; margin: 0 auto;"> PRESS </div>
Joint Information Bureau (EAC)	<div style="border: 1px solid black; width: 100px; height: 50px; display: flex; align-items: center; justify-content: center; margin: 0 auto;"> JIB </div>
Replacement Holding Unit	<div style="border: 1px solid black; width: 100px; height: 50px; display: flex; align-items: center; justify-content: center; margin: 0 auto;"> RHU </div>
Salvage I-27 I-136	<div style="border: 1px solid black; width: 100px; height: 50px; display: flex; align-items: center; justify-content: center; margin: 0 auto;"> SALV </div>
Service	<div style="border: 1px solid black; width: 100px; height: 50px; display: flex; align-items: center; justify-content: center; margin: 0 auto;"> SVC </div>
Supply Supply (Basic symbol) Classes of Supply I-27	<div style="border: 1px solid black; width: 100px; height: 50px; display: flex; align-items: center; justify-content: center; margin: 0 auto;"> </div>
Class I I-27 (Food)	<div style="border: 1px solid black; width: 100px; height: 50px; display: flex; align-items: center; justify-content: center; margin: 0 auto;"> ☾ </div>

OPERATIONAL TERMS AND GRAPHICS

Combat Service Support (Continued)

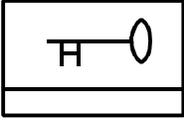
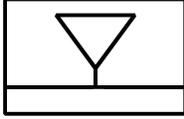
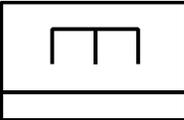
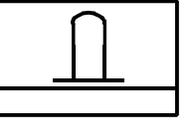
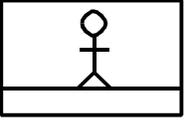
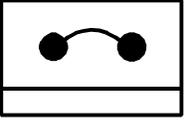
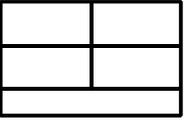
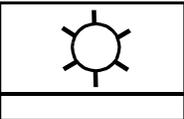
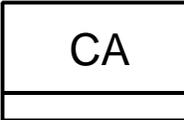
<p>Class II I-27 (Clothing, individual equipment, tentage, organizational tool sets)</p>	
<p>Class III I-27 (Petroleum supply)</p>	
<p>Class IV I-27 (Construction & barrier material)</p>	
<p>Class V I-27 (Ammunition)</p>	
<p>Class VI I-27 (Personal demand)</p>	
<p>Class VII I-27 (Major assemblies)</p>	
<p>Class VIII I-27 (Medical supplies)</p>	
<p>Class IX I-27 (Repair parts)</p>	
<p>Class X I-27 (Agricultural and nonmilitary material not in the other classes of supply)</p>	

Combat Service Support (Continued)

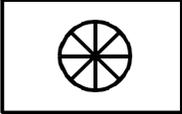
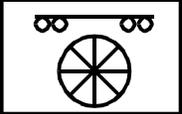
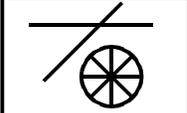
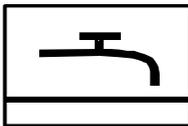
<p>Support</p>	
<p>Transportation Transportation (Basic symbol)</p>	
<p>Railhead I-127</p>	
<p>Seaport (SPOD or SPOE) I-122 I-137</p>	
<p>Airfield/Airport (APOD or APOE) I-3 I-122</p>	
<p>Water I-27</p>	<div style="display: flex; justify-content: space-around; align-items: center;"> <div style="text-align: center;">  <p>Purification</p> </div> <div style="text-align: center;">  <p>Distribution</p> </div> </div>

SPECIAL OPERATIONS FORCES (SOF)

<p>Special Forces (SF)</p>	
<p>Rangers (RGR)</p>	

OPERATIONAL TERMS AND GRAPHICS

Special Operations Forces (SOF) (Continued)

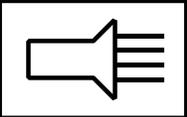
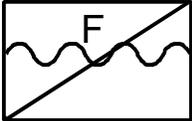
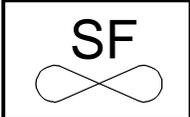
<p>Civil Affairs (CA) 1-26</p>	
<p>Psychological Operations (PSYOP) 1-125</p>	
<p>Marine Force Recon</p>	
<p>SEALS</p>	
<p>Special Forces Aviation Fixed Wing</p>	
<p>Rotary Wing</p>	

Chapter 5 Equipment Symbols

The shadowed boxes **1-16** show the page number for the definition of a symbol or graphic in this chapter .

This chapter describes equipment, weapon, ground vehicle, and aerial vehicle symbols. It describes procedures for creating composite weapon system symbols and the procedures for text labeling to provide necessary details.

The use of the symbol frames shown in Chapter 4 is optional for equipment and recommended only for ships, aircraft, and aerial vehicles.

Orientation of the symbols shown in this chapter is extremely important. All manual and automated displays and overlays should show the symbol oriented the same as the actual equipment. The “Q” field will show the orientation of moving equipment symbols.

Blue or black will represent friendly equipment on color displays and red will represent enemy or hostile equipment. Monochrome displays will use the color available.

EQUIPMENT SYMBOL LABELING

Figures 5-1 through 5-4 show the placement of unit labeling fields around the different symbol frames. Figure 5-5 is a table defining the labeling fields. See Appendix A for examples of fully labeled unit and equipment symbols.

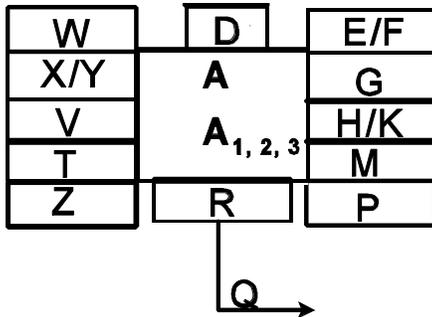

Figure 5-1. Friendly and Neutral Ground Equipment Labeling Fields

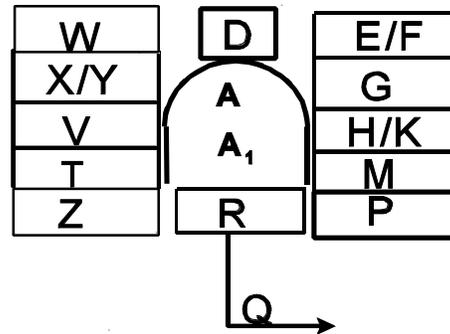

Figure 5-2. Friendly Aerial Vehicle and Aircraft Labeling Fields

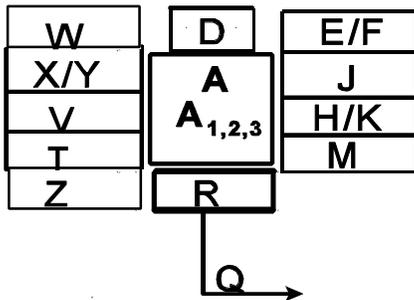

Figure 5-3. Enemy Ground and Naval (Surface) Equipment Labeling Fields

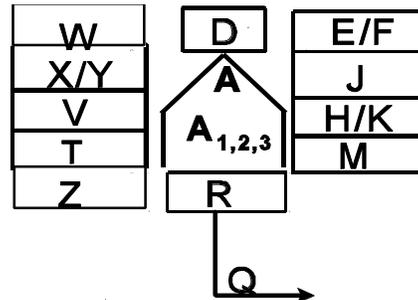

Figure 5-4. Enemy Aerial Vehicles and Aircraft (In Flight) Labeling Fields

Field	Field Title	Description	Application	Length
A	Symbol	Frame shape, fill, and icon showing the basic function of units, installations, or equipment with modifiers A1, A2, and A3	All	(characters)
D	Equipment	Indicates number of items present. Installation : Size in square feet	Units and installations	10
E	Suspect, Assumed Friend, Faker, Joker	Question mark ' ? ' : suspect, assumed friend, faker. ' J ' : joker	All	1
F	Reinforced or Detached	Shows (+) reinforced , (-) reduced, or (+-) reinforced and reduced	Units	3
G	Staff Comments	Free text	All	20
H	Additional Information	Free text	All	20
J	Evaluation Rating	One letter and one number (see STANAG 2022)	Enemy only	2
L	Signature Equipment	Indicated by "!" (refers to detectable electronic signatures)	Enemy equipment only	1
M	Higher Formation	Number or title of higher echelon command (Corps designated by Roman numerals)	All	21
N	Enemy (Hostile)	Indicated enemy by letters "ENY"	Enemy equipment, lines, areas, and boundaries	3
P	IFF/SIF	Identification modes and codes	Units and equipment	5
Q	Direction of Movement Arrow	Direction symbol is moving or will move. Nuclear, biological, chemical: downwind direction	All	4
R	Mobility Indicator	Pictorial representation of mobility	Equipment only	
T	Unique Designation	An alphanumeric title that uniquely identifies a particular symbol; track number. Nuclear: friendly delivery unit (missile, satellite, aircraft, etc)	All	21
V	Type of Equipment	Identifies unique designation. Nuclear: Friendly weapons type	Units and equipment	24
W	Date-Time Group	Alphanumeric field for date/time (MILSTD-2500A) (DDHHMMSSZMONYY) or " o/o " for on order	All	15
X	Altitude / Depth	Altitude portion of GPS. Flight level for aircraft. Depth for submerged objects. Height in feet of equipment or structure on the ground. Nuclear: Height of burst	All	6
Y	Speed	Nautical miles per hour; kilometers per hour	Units and equipment	5
Z	Location	Latitude and longitude; grid coordinates	All	19

Figure 5-5. Equipment Labeling Field Definitions

BUILDING AN EQUIPMENT SYMBOL

The following are example procedures for building a specific equipment symbol. Select the basic equipment symbol.



Rifle/light automatic weapon (M16)

Add horizontal lines to indicate the size or range of a weapon: zero for small, light, or short; one for medium; or two for large, heavy, or long.



Medium machine gun (7.62 mm)

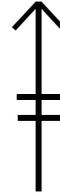

Heavy machine gun (.50 cal)

Add a circle in the center of the line for a grenade launcher.



M203



MK19

If a weapon has a high trajectory, a circle is placed at the base of the shaft.

If the weapon has a flat trajectory, a chevron is placed at the base of the shaft.



Medium mortar

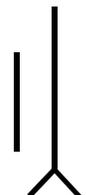

Light antitank gun

If the weapon is primarily for air defense, a horizontal half circle is placed at the base of the shaft.

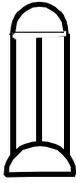

Air defense missile

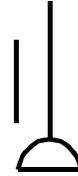

Air defense gun

If the weapon is a rocket launcher, a double arrowhead is placed at the head of the shaft.
If the weapon is also a tracked, self-propelled vehicle, a flat ellipse is placed below the weapon symbol.

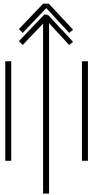

Rocket launcher



Tracked, self-propelled medium howitzer

COMPOSITE WEAPON SYSTEM SYMBOLS

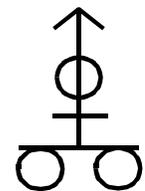

HMMWV
with MK19

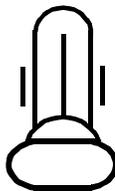

Bradley-Stinger
Fighting Vehicle

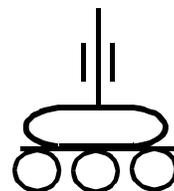

LAV with 25mm

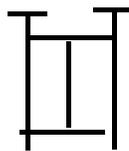

Tank with
Mine Rollers

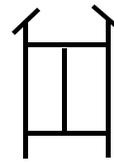

Tank with
Mine Plow

MODIFIERS

Rifle or Automatic Weapon	
Size of Weapon	   <small>small medium large</small>
Antitank Weapon	
Rocket	
Indirect Fire (high trajectory)	
Direct Fire Gun	
Air Defense	
Recoilless Rifle	
Tracked Self-Propelled or Armor-Protected	 

MOBILITY MODIFIERS

Wheeled (limited cross-country)	
Wheeled (cross-country)	
Towed Vehicle or Trailer	
Railway	
Wheeled and Tracked (half track)	
Over-snow (prime mover)	
Sled (towed)	
Pack Animals or Horse-Mounted	
Barge	
Amphibious	

OPERATIONAL TERMS AND GRAPHICS

TYPES OF GROUND EQUIPMENT

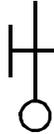
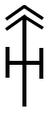
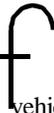
	LIGHT	MEDIUM	HEAVY
Laser			
Howitzer			
Mortar			
Multibarrel Rocket Launcher			
Surface-to-Surface Missiles			
Flame Thrower		 vehicle	
Non-Line-of-Sight Antitank Missile			
Smoke Generator			
Tank (friendly)			

VEHICLE SYMBOLS

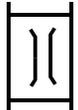
<p>Infantry Fighting Vehicle</p>	
<p>Armored Personnel Carrier</p>	
<p>Cargo or Personnel Carrier</p>	
<p>Train Engine/Locomotive</p>	
<p>Armored Combat Earthmover (ACE)</p>	
<p>Armored Vehicle-Launched Bridge (AVLB)</p>	
<p>Hovercraft</p>	
<p>Armored Vehicle-Mounted MICLIC (AVLM) Trailer-mounted MICLIC</p>	
<p>Tractor, Full-tracked Low-speed (dozer)</p>	
<p>Armored Carrier with Volcano Truck-mounted Volcano</p>	

OPERATIONAL TERMS AND GRAPHICS

AIRCRAFT/AERIAL VEHICLES

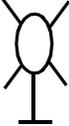
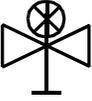
<p>HELICOPTER</p> <p>Civilian</p>	
<p>Attack (Navy; ASW & ASUW)</p>	
<p>Reconnaissance</p>	
<p>Transport (Air Force; HH-53)</p>	
<p>Support (SAR & C2) (Navy; MCM)</p>	

Appendix A Friendly Unit and Equipment Symbols

HIGH LEVEL COMMANDS

<p>ARMY SERVICE COMPONENT COMMANDS 1-11 United States Army, Europe</p>	<p style="text-align: center;">XXXX</p> <div style="display: flex; align-items: center; justify-content: center;"> <div style="border: 1px solid black; padding: 5px; margin-right: 10px;">USAREUR</div> EUCOM </div>
<p>United States Army, Pacific</p>	<p style="text-align: center;">XXXX</p> <div style="display: flex; align-items: center; justify-content: center;"> <div style="border: 1px solid black; padding: 5px; margin-right: 10px;">USARPAC</div> PACOM </div>
<p>Forces Command</p>	<p style="text-align: center;">XXXX</p> <div style="display: flex; align-items: center; justify-content: center;"> <div style="border: 1px solid black; padding: 5px; margin-right: 10px;">FORSCOM</div> LANTCOM </div>
<p>Third US Army</p>	<p style="text-align: center;">XXXX</p> <div style="display: flex; align-items: center; justify-content: center;"> <div style="border: 1px solid black; padding: 5px; margin-right: 10px;">TUSA</div> CENTCOM </div>
<p>US Army South</p>	<p style="text-align: center;">XXXX</p> <div style="display: flex; align-items: center; justify-content: center;"> <div style="border: 1px solid black; padding: 5px; margin-right: 10px;">USARSO</div> SOUTHCOM </div>
<p>Eighth US Army</p>	<p style="text-align: center;">XXXX</p> <div style="display: flex; align-items: center; justify-content: center;"> <div style="border: 1px solid black; padding: 5px; margin-right: 10px;">EUSA</div> USFK </div>
<p>FIELD ARMY Field Army (With Corps Attached)</p>	<p style="text-align: center;">XXXX</p> <div style="display: flex; align-items: center; justify-content: center;"> <div style="border: 1px solid black; padding: 5px; margin-right: 10px; width: 60px; height: 40px;"></div> CENTCOM </div> <p style="margin-left: 10px;">3</p>



OPERATIONAL TERMS AND GRAPHICS

High Level Commands (Continued)

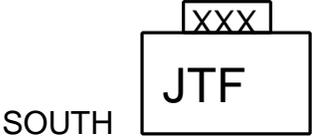
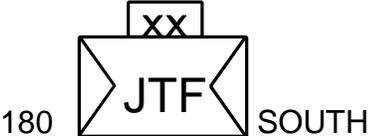
<p>JOINT TASK FORCE COMMANDS I-88 Joint Task Force South</p>	
<p>Joint Support Command</p>	

HEADQUARTERS TYPES

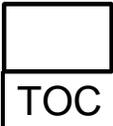
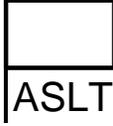
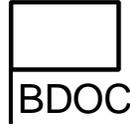
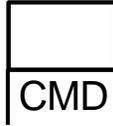
<p>Tactical Operations Center (TOC) I-150</p>	
<p>Assault Command Post (ASLT) I-12</p>	
<p>Base Defense Operations Center (BDOC) I-16</p>	
<p>Command Group (CMD GP) I-34</p>	

Headquarters Types (Continued)

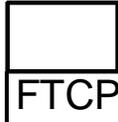
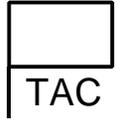
<p>Combat Trains Command Post (CTCP) 1-32</p>	
<p>Field Trains Command Post (FTCP) 1-65</p>	
<p>Forward Command Post (FWD)</p>	
<p>Main Command Post (MAIN) 1-95</p>	
<p>Rear Command Post (REAR) 1-129</p>	
<p>Tactical Command Post (TAC) 1-150</p>	

USMC

<p>Marine air-ground task force (MAGTF) 1-32</p>	
---	---

EXAMPLES OF UNITS IN DIVISIONS

Airborne Division

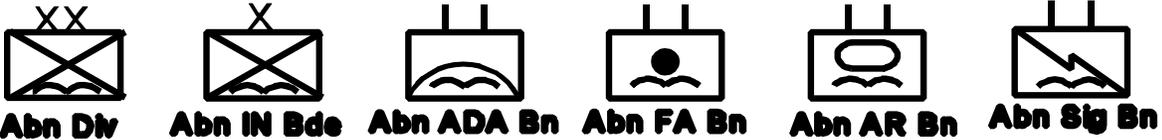

Air Assault Division

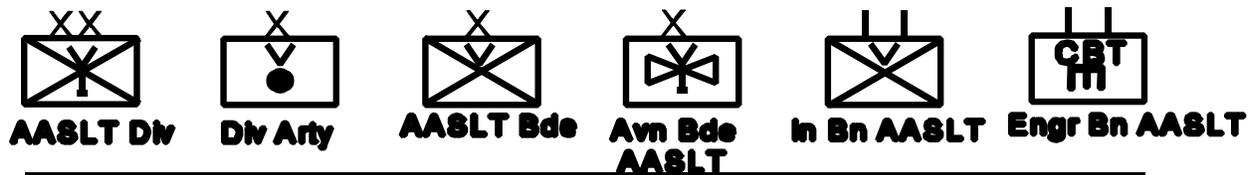

Armored Division

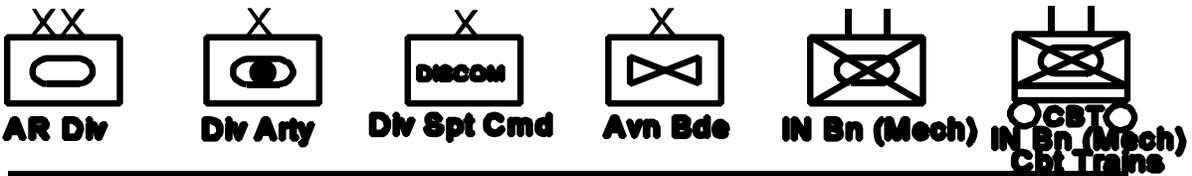

Mechanized Division

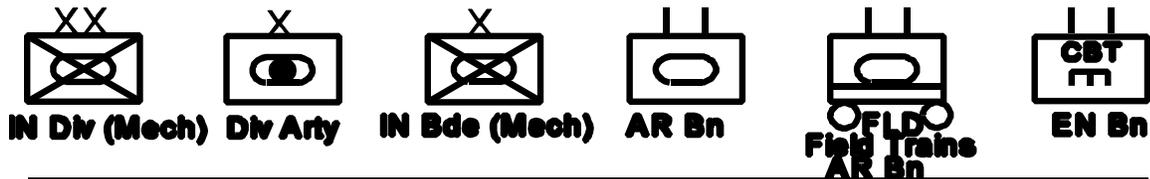

Infantry Division (Light)

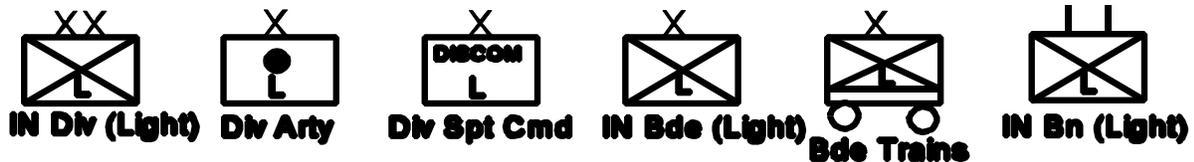

Infantry Division

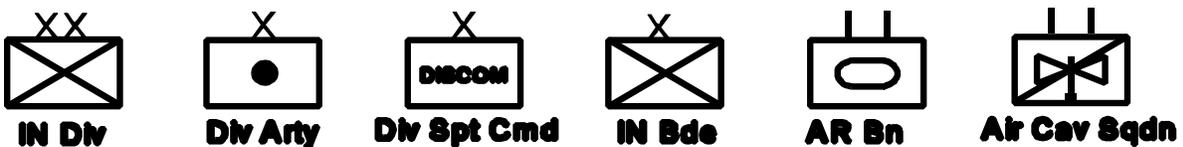

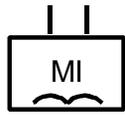

Abn MI Bn

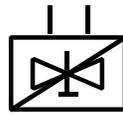

Air Cav Sqdn

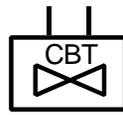

Cbt Avn Bn

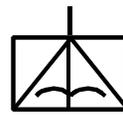

Abn AT Co

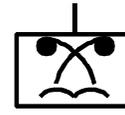

Abn Chem Co

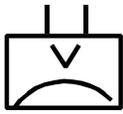

ADA Bn
AASLT

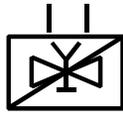

Air Cav Sqdn
AASLT

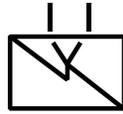

Sig Bn AASLT

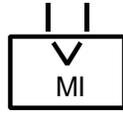

MI Bn AASLT

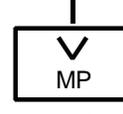

MP Co
AASLT

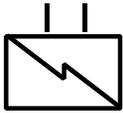

Sig Bn

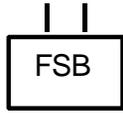

Fwd Spt Bn

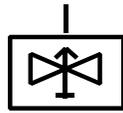

Atk Hel Co

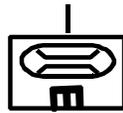

Bridge Co
En Bn

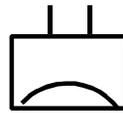

ADA Bn

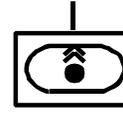

MLRS Btry

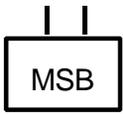

Main Spt Bn

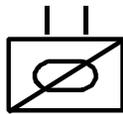

Cav Sqdn

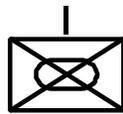

Mech In Co

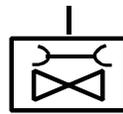

AVIM

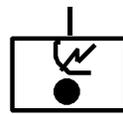

Tgt Acq Btry



Cmd Avn Co

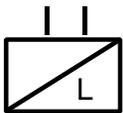

Recon Bn
(Light) In Div

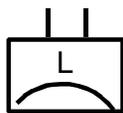

ADA Bn

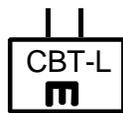

En Bn

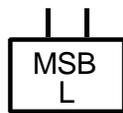

Main Spt Bn

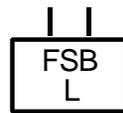

Fwd Spt Bn

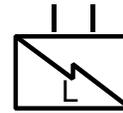

Sig Bn



Cmd Avn Bn

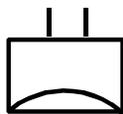

ADA Bn

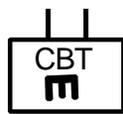

En Bn

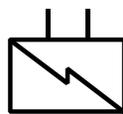

Sig Bn

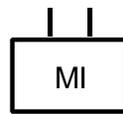

MI Bn

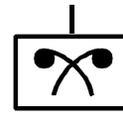

Chem Co

OPERATIONAL TERMS AND GRAPHICS

EXAMPLES OF SUPPLY SITES



Water



Class I

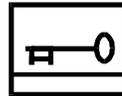

Class II



Multiple Classes



Class III
Army Aviation



Class III
Ground



Class III
Solid Fuel



Class IV

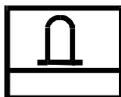

Class V
All Types



Class V
Air Defense



ASP

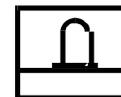

ATP



Class V
Army Aviation



Class V
Artillery



Class V
Mines & Explosives



Class V
Rocket Artillery



Class V
Small Arms



Class V
Tank

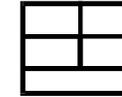

Class VIII

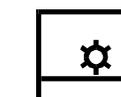

Class IX



All Classes

EXAMPLES OF COMBAT SERVICE SUPPORT UNITS

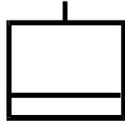

Division Supply Company

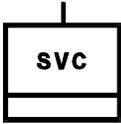

Division Supply and Services Company

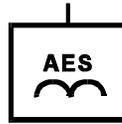

Airdrop Equipment Support Company



Tactical Field Exchange

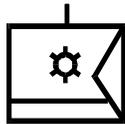

Repair Parts Supply Company (GS)

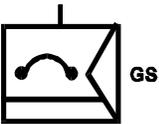

Heavy Materiel Supply Company (GS)

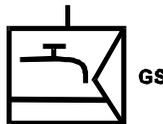

Water Supply Company (GS)

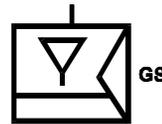

Petroleum Supply Company (GS)



Light Airdrop Supply Company



Heavy Airdrop Supply Company

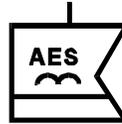

Airdrop Equipment Support Company



Airdrop Equipment Repair and Supply Company

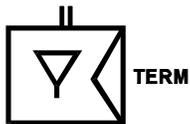

Petroleum Pipeline and Terminal Operating Bn

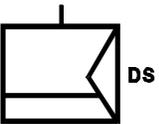

Supply Company (DS)

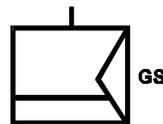

Supply Company (GS)

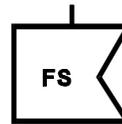

Field Service Company



Petroleum Group



Mortuary Affairs Company

OPERATIONAL TERMS AND GRAPHICS

EXAMPLES OF UNIT SYMBOLS WITH LABELING FIELDS

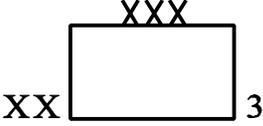
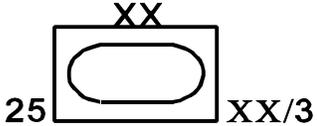
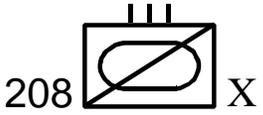
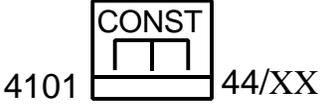
<p>Twentieth Corps, Third Army.</p>	
<p>Twenty-fifth Armored Division, Twentieth Corps, Third Army.</p>	
<p>208th Armored Cavalry Regiment, Tenth Corps</p>	
<p>Engineer construction supply site for the 4101st En Const Spt Co, 44th En Gp, Twentieth Corps.</p>	

EXAMPLES OF EQUIPMENT SYMBOLS WITH LABELING FIELDS

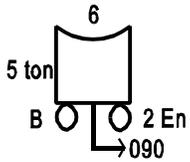
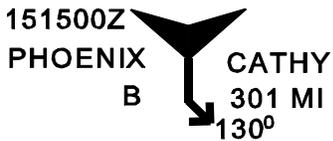
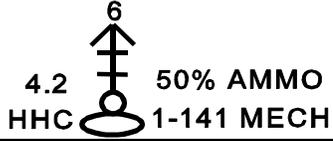
<p>Six 5-ton trucks from B Co, 2d Engr, moving east.</p>	
<p>An UAV launch site of B Co, 301 MI Bn, launch direction 130 degrees, "Phoenix" type UAV, to air corridor "Cathy", next launch at 1500Z on the 15th of the current month.</p>	
<p>Six 4.2-in mortars, in M113s from HHC Co, 1st Bn, 141st IN(M), at 50% of its ammo</p>	

Equipment Symbols with Labeling Fields (Continued)

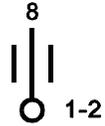
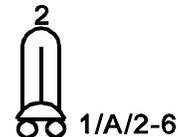
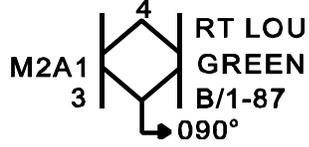
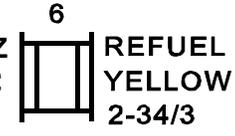
<p>Eight 155-mm towed howitzers of Btry A, 1st Bn, 2d FA, valid as of 0800Z the 7th of the current month</p>	<p>070800Z 155 A</p>  <p>1-2</p>
<p>Two STINGER missiles from 1st Section 1st Plt, A Btry, 2d Bn, 6th ADA, in HUMMWVs. Location valid as of 1000Z the 11th of the current month.</p>	<p>111000Z STING</p>  <p>1/A/2-6</p>
<p>Four IFVs of the 3d Plt, B Co, 1st Bn, 87th IN(M) with a "green" readiness rating and moving east on Route LOU.</p>	<p>M2A1</p>  <p>RT LOU GREEN B/1-87 090°</p>
<p>Six M-1A2 tanks from A Co, 2-34 Armor, 3d Bde, refueling as of 0600Z the 21st, "yellow" status.</p>	<p>210600Z M1A2 A</p>  <p>REFUEL YELLOW 2-34/3</p>
<p>Three MLRS from A Btry, 3d Bn, 16th FA, in a hide position.</p>	<p>A</p>  <p>HIDE 3-16 FA</p>

Appendix B Enemy Unit and Equipment Symbols

EXAMPLES OF ENEMY COMBAT UNITS

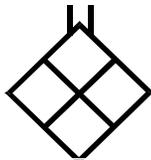

Infantry
Battalion

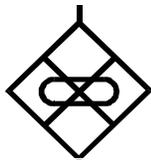

Mech In
Company

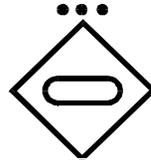

Armor
Platoon

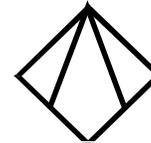

Antitank

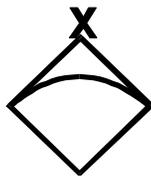

Air Defense
Brigade

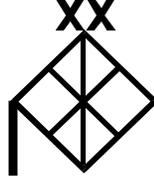

Motorized In
Division HQ

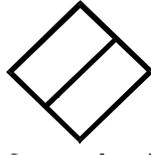

Cavalry/
Reconnaissance

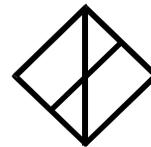

Motorized
Scouts

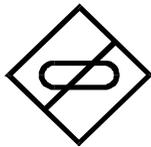

Armored
Cavalry/Scouts



Attack Helicopter
(On Ground)



Attack Helicopter
Company (In Flight)

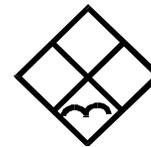

Airborne
Infantry

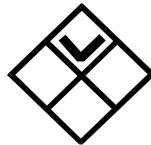

Air Assault In
(Without Aircraft)

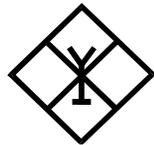

Air Assault In
(With Aircraft)

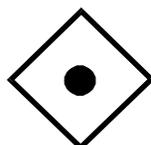

Artillery

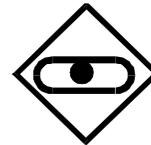

Self-Propelled
Artillery

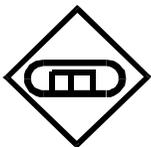

Mechanized
Engineers

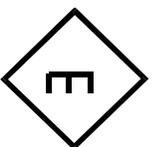

Engineers



Air Defense
Radar



Artillery Locating
Radar

EX

OPERATIONAL TERMS AND GRAPHICS

AMPLES OF ENEMY COMBAT SUPPORT UNITS

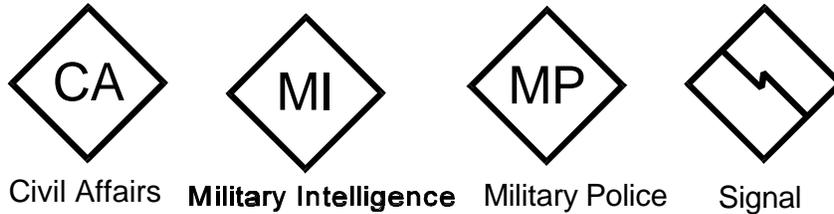

EXAMPLES OF ENEMY COMBAT SERVICE SUPPORT UNITS

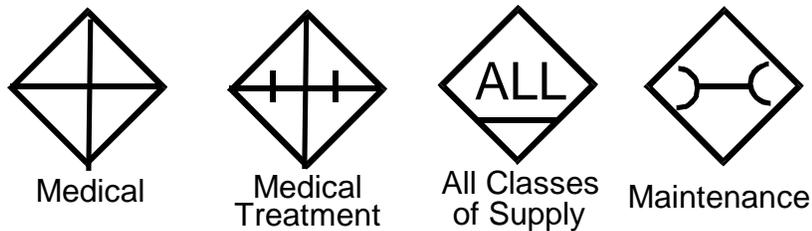

EXAMPLES OF ENEMY EQUIPMENT

Enemy tank	
Enemy wheeled infantry fighting vehicle	
Enemy tracked infantry fighting vehicle	
An enemy 57-mm antitank gun, reported at this location at 1200Z on the 12th of the current month.	<p>121800Z 57</p> <p>ENY</p>

Appendix C

Military Decisionmaking Process and Tactical Mission Graphics

The basic tenets of Army doctrine are initiative, depth, agility, synchronization, and versatility. If commanders and staffs are to adhere to these tenets, they need information in a format that assists them to adapt quickly to the changing factors of METT-T. The graphics portrayed in Chapters 3 through 5 are used to plot locations and directions of movement; however, the decision maker normally requires additional information not readily available by studying a current situation map. The battlefield envisioned by our current doctrine requires rapid and frequent changes in task organization of units to retain or take the initiative and move optimally task-organized forces to the critical point on the battlefield. Military decisionmaking process graphics are a tool for portraying the necessary information.

STATUS AND ASSESSMENT CHARTS

Commanders require two general categories of information when analyzing the situation map: the status of equipment and personnel, and the composition of the task-organized forces. Two common methods for displaying information and identifying status are the bar chart and the gumball chart.

Bar Chart

The bar chart is used to display quantities or percentages. Its major advantage is that it provides a simple method for comparing status indicators to each other and to a set, standard reference point. Bar charts also give the staff flexibility to display and relate various types and combinations of information for the commander. Figure C-1, page C-2, shows examples of various styles and information.

Gumball Chart

The gumball chart provides a clear picture of the status of designated elements using a color code established in the unit standing operating procedures. The chart assists the commander to quickly assess the status of critical elements and assists the staff to focus on problem areas. The color code chosen should be consistent throughout all echelons of the command. The following is a commonly used color code: GREEN indicates that the unit is at 85 percent or greater strength (combat capable); AMBER indicates that the unit is at 70 to 84 percent strength (combat capable with minor deficiencies); RED indicates that the unit is at 50 to 69 percent strength (combat ineffective, unit has major losses or deficiencies); and BLACK indicates that the unit is at less than 50 percent strength (requires reconstitution before next mission). See the example in Figure C-2, page C-3.

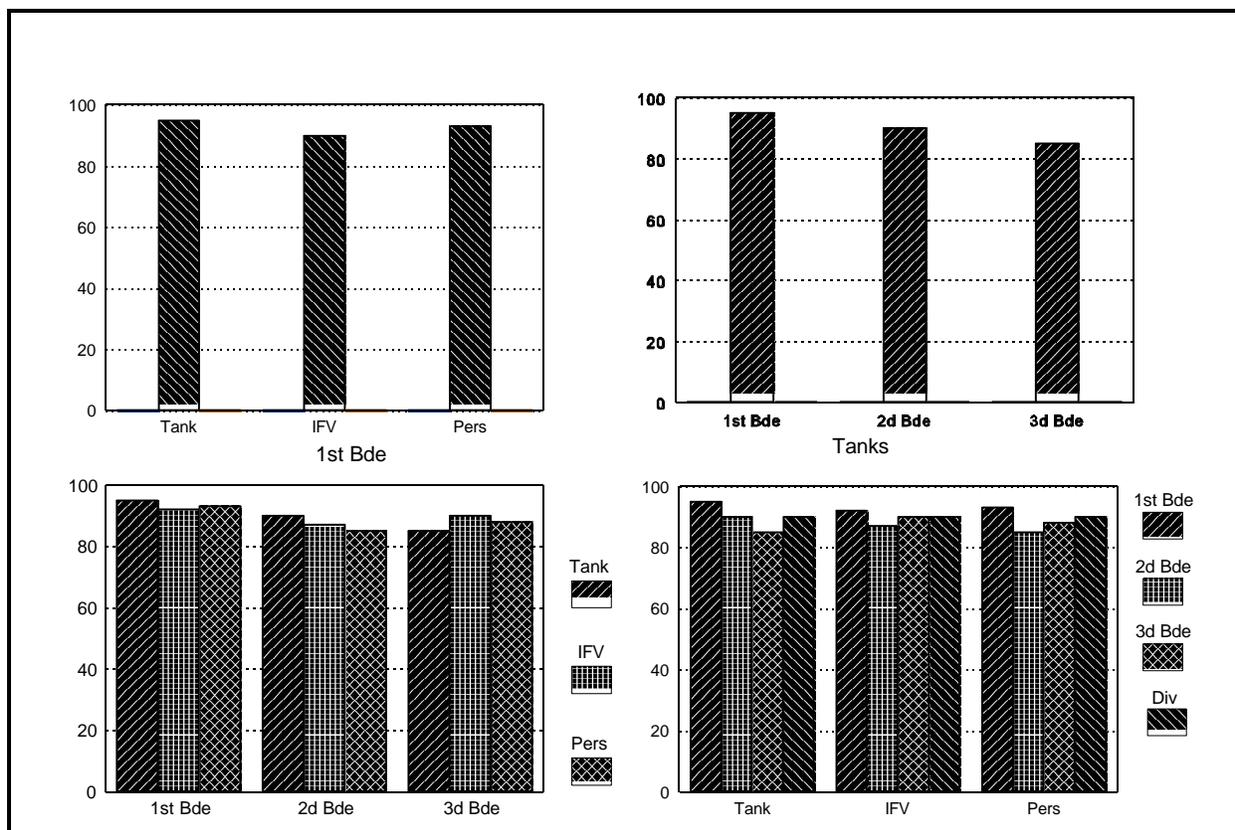

Figure C-1. Example Bar Type Status Charts

Combat Effectiveness Graphics

Situation reports (SITREPs) focus on the collection of information about the ability of subordinate units to perform their mission. Appropriate staff elements use various formats to report factors such as the status of fuel, ammunition, vehicle availability, and personnel. The task force commander, however, provides the net assessment of his unit's ability to perform the mission. This assessment can be expressed using decision graphics as shown in Figure C-3, page C-4.

The center column of Figure C-3 visually depicts the overall combat rating of the unit, and the right column specifies the status of selected items of interest. The standing operating procedures (SOP) will specify the items of interest to be reported higher. The subordinate commander may add to this list for his internal reporting and tracking. The four items shown in the right column are ammunition, weapons, POL, and personnel.

	Overall	Tanks	BFVs	Pers
1st Brigade	○	○	○	○
2d Brigade	○	○	○	○
3d Brigade	○	○	○	○

	Now	24 hours	48 hours
1st Brigade	○	○	○
Tanks	○	○	○
BFVs	○	○	○
Personnel	○	○	○
2d Brigade	○	○	○
Tanks	○	○	○
BFVs	○	○	○
Personnel	○	○	○
3d Brigade	○	○	○
Tanks	○	○	○
BFVs	○	○	○
Personnel	○	○	○

Figure C-2. Example of Gumball Charts

Note: The circles (gumballs) would be filled in with appropriate colors (GREEN/AMBER/RED/BLACK).

OPERATIONAL TERMS AND GRAPHICS

Commander's Assessment of Ability to Perform Mission	Effectiveness Pie Chart	Selected Status Pie Chart
"No Problem"		Personnel  Ammo POL  Weapons
"Some Problems" (Personnel)		
"Major Problems" (Weapon Systems)		
"Can't Perform Mission" (Personnel, Ammunition, Weapon Systems)		

Figure C-3. Example of Combat Effectiveness Graphics

TASK-ORGANIZED COMPOSITION GRAPHICS

The assets available to a commander are established in the operation order and may be later modified by fragmentary and warning orders. The composition of task-organized forces may be portrayed by using the standard symbol system. These symbols do not provide decision makers with a graphic portrayal of information relating to task-organized composition. Figure C-4 on this page and C-5 on the next page show a task force organized around the headquarters of the 1st Battalion, 72d Infantry Regiment (Mechanized), of the 1st Brigade, 52d Infantry Division (Mechanized). The task force unit symbol (Figure C-4) does not tell the decision maker how the unit is organized or what the overall combat effectiveness may be.

Although this data may be available through other charts, reports, and briefings, its impact can be lost when it is in various locations. Figure C-5 shows TF 1-72 as a task-organized composition graphic. Figure C-6 on page C-6 shows examples of "shorthand" unit symbols for use as decision graphics.

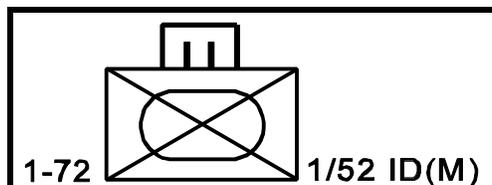

Figure C-4. Task Force Unit Symbol

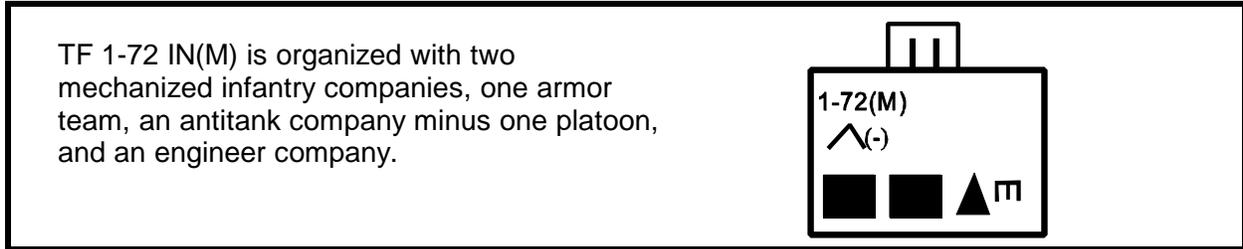

Figure C-5. Example of a Task-Organized Composition Graphic

Armor	
Armored Cavalry	
Infantry	
Air Assault Infantry	
Airborne Infantry	
Light Infantry	
Mechanized Infantry	
Mountain Infantry	
Medium	
Antitank (Mechanized)	

Figure C-6. Shorthand Unit Symbols

OPERATIONAL TERMS AND GRAPHICS

Engineer	
Air Defense	
Artillery	
Attack Helicopter	
Air Cavalry	
Lift/Assault Helicopters	

Figure C-6. Shorthand Unit Symbols (Continued)

DECISION GRAPHICS

Combat effectiveness graphics and task-organized composition graphics can be combined to form decision graphics. Examples of composite decision graphics at the company/team, battalion/task force, and brigade levels are at Figures C-7, 8, and 9. Green, amber, red, or black can be used for the fill colors or outlines of the unit decision graphics to show the status of the subordinate units.

Subordinate units are assumed to be one echelon lower than the parent organization. If any subordinate unit is not one echelon lower, a size indicator should be used for clarity. For example, Task Force 1-6 Armor shows the platoon size indicator over the air defense artillery platoon shorthand symbol (Figure C-8) because the platoon is two echelons lower than the parent organization (TF 1-6 Armor). Figure C-9 shows an example of a brigade-level decision graphic.

Tm A, 1st Bn, 72d IN(M), is organized with two mechanized infantry platoons and one armor platoon. It has “some difficulty” performing its mission because of deadlined weapon systems.

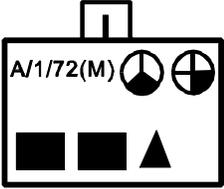

Figure C-7. Example Company Team Decision Graphic

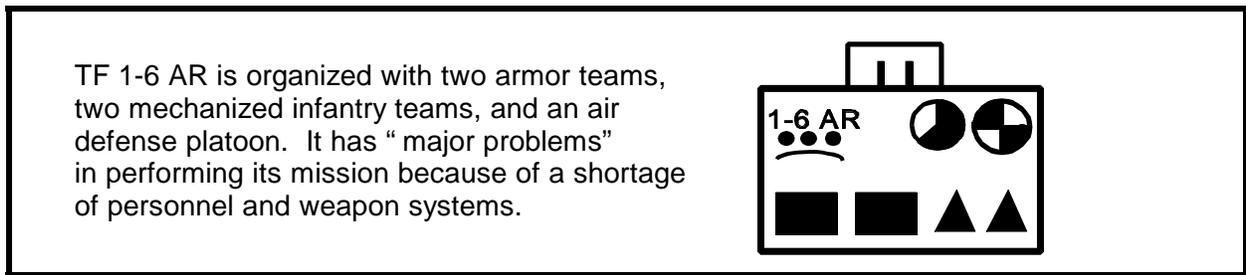

Figure C-8. Example of a Task Force Decision Graphic

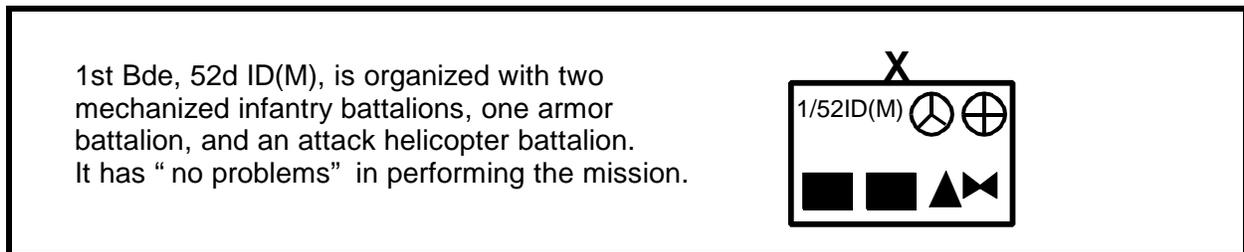

Figure C-9. Example of a Brigade Decision Graphic

MISSION GRAPHICS

Tactical task graphics are for use in course of action sketches, synchronization matrixes, and maneuver sketches. They do not replace any part of the operation order. The graphics should be scaled to fit the map scale and size of unit for which they are being used. The examples shown here are for illustration purposes only. Where practical the task graphic should connect with the decision graphic or unit graphic where the "Q" labeling field is (center of the bottom of the symbol).

Figure C-10 below shows that the 1st Brigade, 52d Infantry Division (Mechanized), is task-organized with two mechanized infantry battalions, an armor (tank) battalion, and an attack helicopter battalion. It has no deficiencies. Its task is to seize objective Tina. The 2d Brigade, 52d Infantry Division (Mechanized), is task-organized with two mechanized infantry battalions and two armor (tank) battalions. It has no deficiencies. Its task is to follow and support the first brigade.

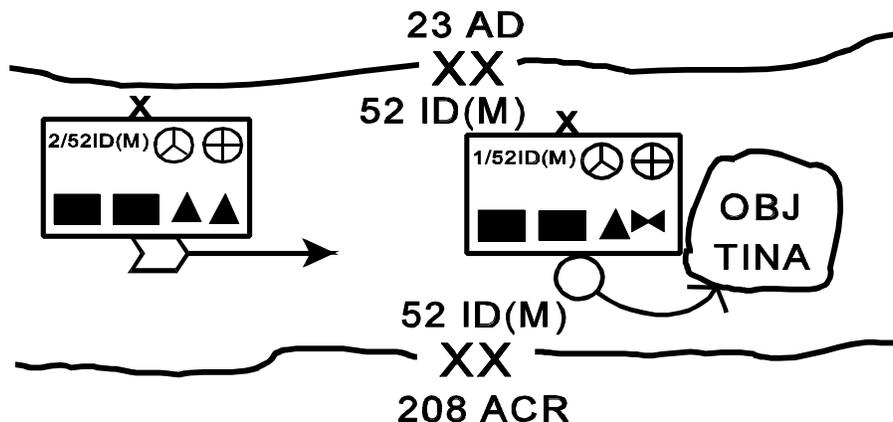
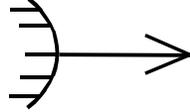
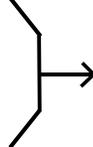
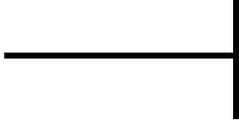
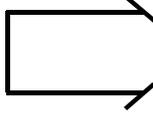
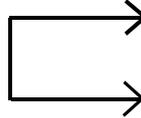
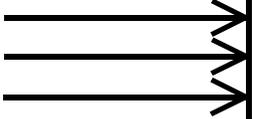
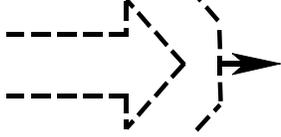
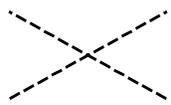
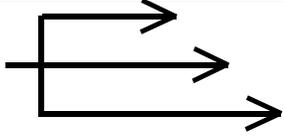
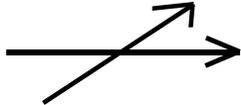

Figure C-10. Example of Use of Decision Graphics and Mission Graphics

TACTICAL MISSION GRAPHICS

<p>Ambush I-8</p>	
<p>Attack by Fire I-13</p>	
<p>Block I-20</p>	
<p>Breach I-21</p>	
<p>Bypass I-23</p>	
<p>Canalize I-23</p>	
<p>Clear I-28</p>	
<p>Contain I-37</p>	

Tactical Mission Graphics (Continued)

<p>Counterattack I-39 (Axis is always dashed.)</p>	
<p>Counterattack by Fire I-70</p>	
<p>Delay I-48, I-49</p>	
<p>Delay (until a specified time) I-48, I-49</p>	
<p>Destroy I-51</p>	
<p>Disrupt I-55</p>	
<p>Fix I-68</p>	
<p>Follow and Assume I-69</p>	
<p>Follow and Support I-69</p>	
<p>Interdict I-84</p>	

OPERATIONAL TERMS AND GRAPHICS

Tactical Mission Graphics (Continued)

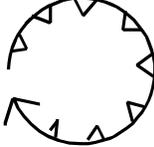
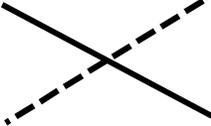
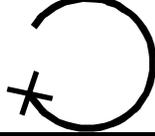
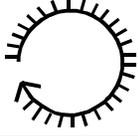
<p>Isolate I-86</p>	
<p>Neutralize I-109</p>	
<p>Occupy I-113</p>	
<p>Penetrate I-120</p>	
<p>Relief in Place I-132</p>	
<p>Retain I-133</p>	
<p>Retirement I-134</p>	
<p>Secure I-138</p>	

Tactical Mission Graphics (Continued)

<p>Security (Arrowheads touch graphics which define the limits of the task.) 1-138 screen 1-137 guard 1-74 cover 1-41</p>	
<p>Seize 1-138</p>	
<p>Support by Fire 1-147</p>	
<p>Withdraw 1-163</p>	
<p>Withdraw under Pressure 1-163</p>	

EXAMPLES

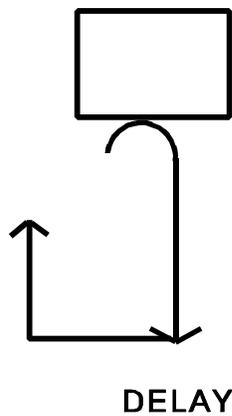
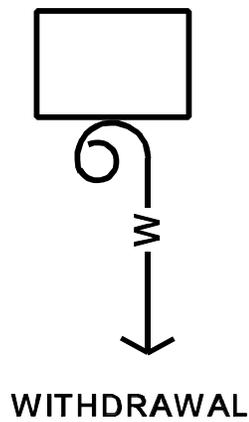

IN POSITIONS

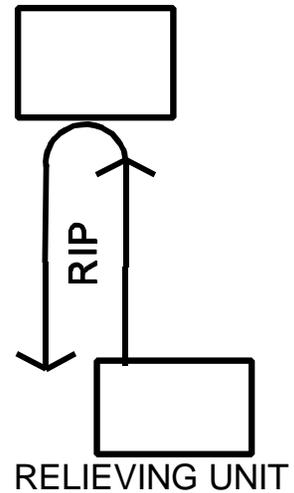

Appendix D

Stability and Support Operations Symbology

During recent stability and support operations, units have found a need to use symbols to track incidents and to support intelligence preparation of the battlefield. This appendix includes examples of symbols used to depict common events in a stability and support operations environment and shows the pattern of developing additional symbols from doctrinal symbols or other easily drawn and understood symbols. Any symbols which deviate from a combination of symbols in this manual must be shown in the margin of the overlay with a legend explaining their meaning.

NOTE: The terms insurgent and hostile are used to describe any force, faction, or political group that is opposed to United States forces presence, the National Security Objectives of the United States, United Nations peacekeeping actions, and humanitarian assistance efforts, or that commits unlawful activities. The terms are also used to describe violent acts against Americans, allies, or friendly factions.

FRIENDLY UNITS, ACTIVITIES, OR FACILITIES

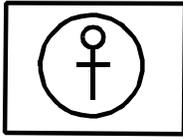
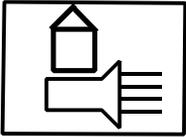
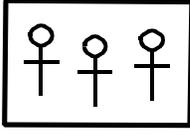
<p>Arrest (Arrest of hostiles by friendly military, police, or other paramilitary organizations friendly to US Forces and goals.)</p>	
<p>Demonstration I-50</p>	
<p>House-to-House Propaganda I-125</p>	
<p>Internal Security Force (ISF) (Paramilitary organizations or militias, whose primary purpose is internal defense.)</p>	
<p>Refugees I-131</p>	

OPERATIONAL TERMS AND GRAPHICS

Friendly Units, Activities, or Facilities (Continued)

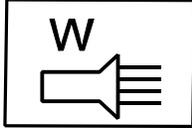
<p>Safe House I-136</p>	
<p>Written Propaganda I-125</p>	

HOSTILE ACTIVITIES, UNITS, OR FACILITIES

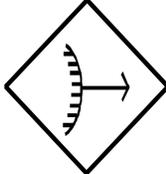
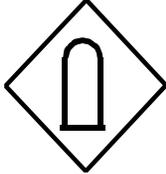
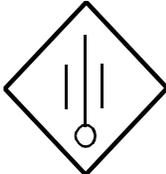
<p>Ambush</p>	
<p>Ammunition Cache</p>	
<p>Arson/Fire</p>	
<p>Artillery/Artillery Fire</p>	

Hostile Activities, Units, or Facilities (Continued)

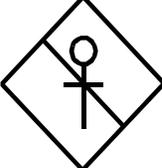
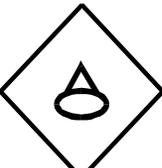
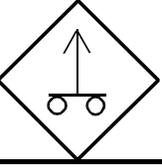
<p>Assassination/Murder/Execution</p>	
<p>Black List Location 1-19</p>	
<p>Bomb/Bombing</p>	
<p>Boobytrap 1-20</p>	
<p>Demonstration</p>	
<p>Drive by Shooting</p>	
<p>Drug Operation</p>	

OPERATIONAL TERMS AND GRAPHICS

Hostile Activities, Units, or Facilities (Continued)

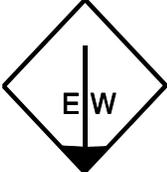
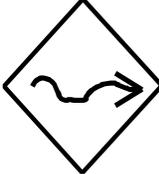
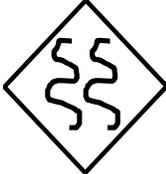
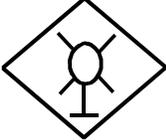
<p>Drug Vehicle</p>	
<p>Electronic Warfare Intercept</p>	
<p>Extortion</p>	
<p>Foraging/Searching</p>	
<p>Graffiti</p>	
<p>Gray List Location 1-73</p>	
<p>Helicopter (civilian being used by hostiles or insurgents)</p>	

Hostile Activities, Units, or Facilities (Continued)

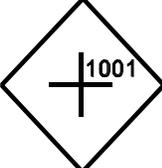
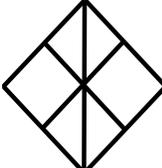
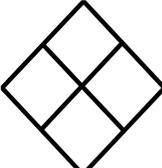
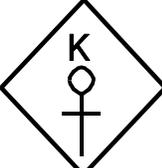
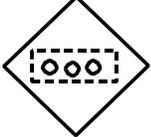
<p>Hijacking</p>	 <p>VEHICLE AIRPLANE BOAT</p>
<p>Indirect Fire (Unspecified Type) (The number sequentially records the number of indirect fire incidents.)</p>	
<p>Hostile or Insurgent Motorized Infantry</p>	
<p>Hostile or Insurgent Infantry</p>	
<p>Kidnapping</p>	
<p>Known Insurgent Vehicle</p>	
<p>Minelaying (in progress)</p>	

OPERATIONAL TERMS AND GRAPHICS

Hostile Activities, Units, or Facilities (Continued)

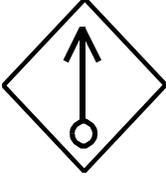
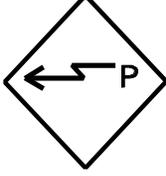
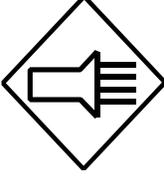
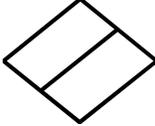
<p>Mortar/Mortar Fire</p>	
<p>Patrolling</p>	
<p>Poisoning</p>	
<p>Psychological Operations (PSYOP) I-125</p>	
<p>PSYOP (TV and radio propaganda) I-125</p>	
<p>PSYOP (written propaganda) I-125</p>	
<p>Reconnaissance/Surveillance</p>	

Hostile Activities, Units, or Facilities (Continued)

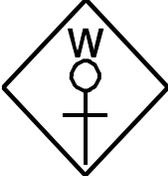
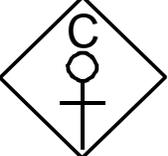
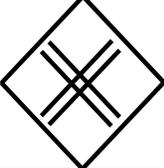
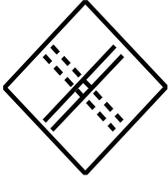
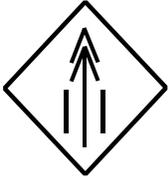
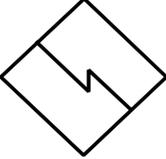
<p>Recruitment (willing)</p>	
<p>Recruitment (coerced/impressed)</p>	
<p>Roadblock (completed/in-place)</p>	
<p>Roadblock (under construction)</p>	
<p>Rocket/Rocket Fire</p>	
<p>Safe House I-136</p>	
<p>Signal/Radio Station</p>	

OPERATIONAL TERMS AND GRAPHICS

Hostile Activities, Units, or Facilities (Continued)

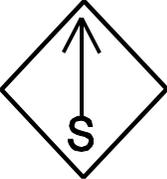
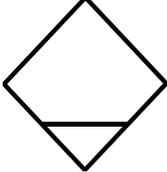
<p>Sniping</p>	
<p>Spy</p>	
<p>Supply Cache</p>	
<p>Vandalism/Rape/Loot/Ransack/ Plunder/ Sack</p>	
<p>White List Location I-163</p>	

NEUTRAL (NGO OR PVO) ACTIVITIES, UNITS, OR FACILITIES

<p>Food Distribution (by an NGO I-110 or PVO I-124)</p>	
---	---

Neutral (NGO or PVO) Activities, Units, or Facilities (Continued)

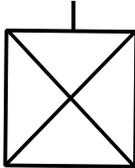
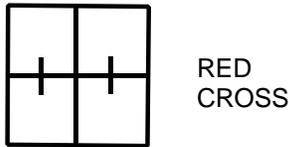
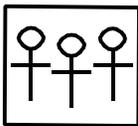
<p>Infantry Unit</p>	
<p>Medical Treatment Facility (Established by the Red Cross, a PVO) 1-99</p>	
<p>Refugees</p>	

UNKNOWN ACTIVITIES, UNITS, OR FACILITIES

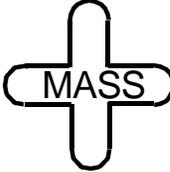
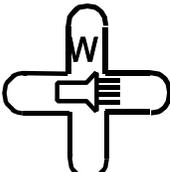
<p>Bomb/Bombing</p>	
<p>Demonstration</p>	
<p>PSYOP (written)</p>	

GRAPHIC CONTROL MEASURES

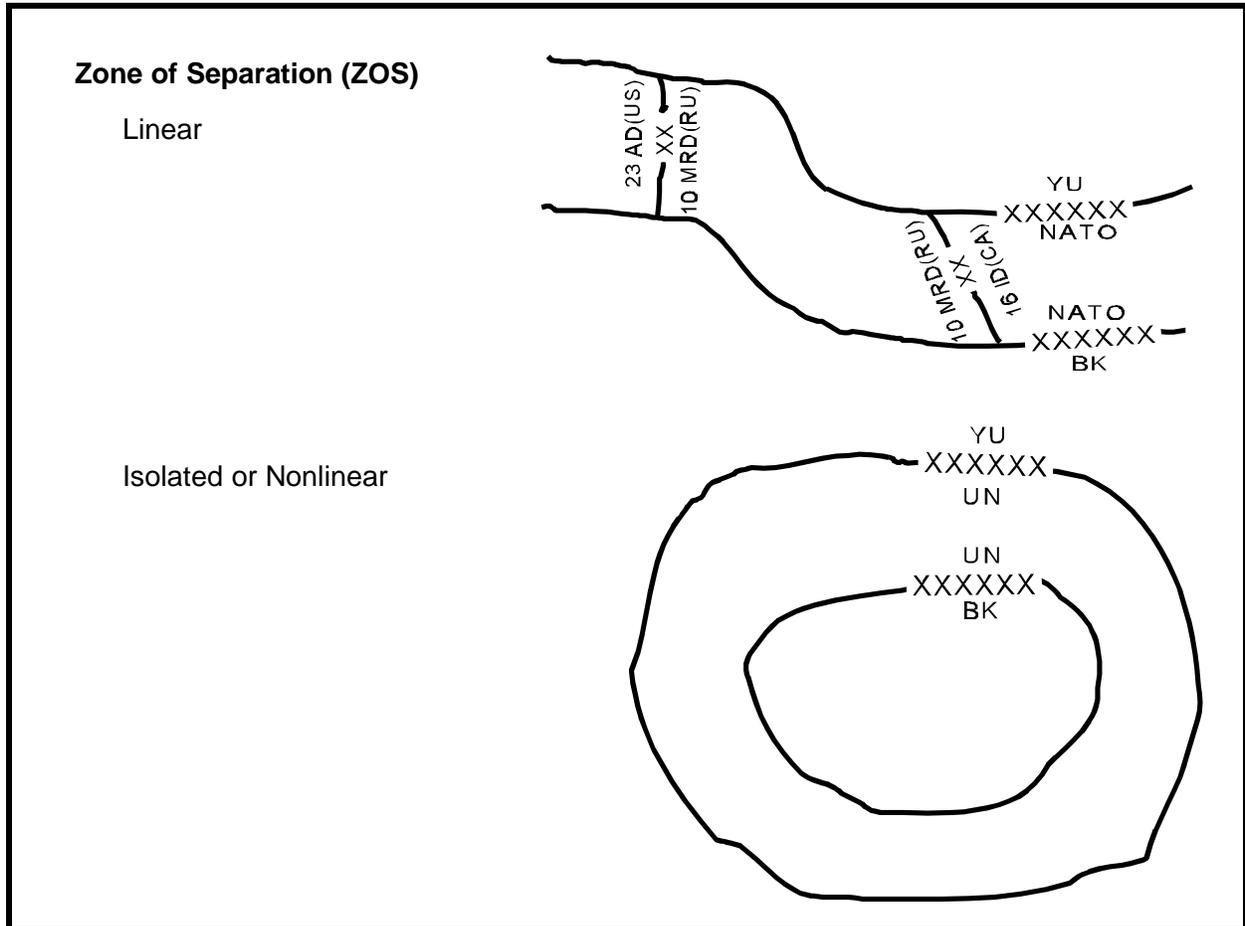

Appendix E

Multiservice Tactical Brevity Codes

This appendix standardizes air-to-air, surface-to-air, and air-to-surface brevity code words. The scope is limited to those brevity codes used in multiservice operations and does not include words unique to single service operations. While these codes are not authoritative in nature, all services agree to their meanings. Using the codes eases coordination and improves understanding during multiservice operations. The codes are intended for use by air and ground operations personnel at the tactical level. Code words that are followed by an asterisk (*) may differ in meaning from NATO usage.

CODE LIST

ABORT(ING)(ED)	Directive/informative call to cease action/attack/event/mission.
ACTION	Directive to initiate a briefed attack sequence or maneuver.
ACTIVE	An emitter is radiating.
ADD()	Directive call to add a specific (system) or (electronic order of battle (EOB) category) to search responsibility.
ALARM	Directive/informative call indicating the termination of emission control (EMCON) procedures.
ALLIGATOR	Link-11/ tactical digital information link (TADIL) A.
ALPHA CHECK	Request for/confirmation of bearing and range to described point.
ANCHOR(ED)	1. Orbit about a specific point; refueling track flown by tanker. 2. Informative call to indicate a turning engagement about a specific location.
ANGELS	Height of friendly aircraft in thousands of feet.
ARIZONA	No antiradiation missile (ARM) ordnance remaining.
AS FRAGGED	Unit or element will be performing exactly as stated by the air tasking order (ATO).
AUTHENTICATE	To request or provide a response for a coded challenge.
AUTOCAT	Any communications relay using automatic retransmissions.
AZIMUTH	Two or more groups primarily separated in bearing.

OPERATIONAL TERMS AND GRAPHICS

BANDIT	An aircraft identified as enemy, in accordance with theater ID criteria. The term does not necessarily imply direction or authority to engage.
BANZAI	Informative call or directive to execute launch and decide tactics.
BASE (Number)	Reference number used to indicate such information as headings, altitude, and fuels.
BEAD WINDOW	Last transmission potentially disclosed unauthorized information.
BEAM(ING)	Target stabilized within 70 to 110 degree aspect; generally (Direction) given with cardinal directions: east, west, north, or south.
BENT	System indicated is inoperative.
BINGO	<ol style="list-style-type: none">1. Fuel state needed for recovery.2. Proceed/am proceeding to specified base (field) or carrier.
BIRD	Friendly surface-to-air missile (SAM).
BIRD(S) AFFIRM	Surface to Air (S/A) informative call indicating unit is able and prepared to engage a specified target with SAMs (presumes target is within or will enter the SAM engagement envelope).
BIRD(S) AWAY	Friendly SAM has been fired at designated target.
BIRD(S) NEGAT	S/A informative call indicating unit is unable to engage a specified target with SAMs. Opposite of BIRD(S) AFFIRM.
BITTERSWEET	Notification of possible BLUE ON BLUE situation relative to a designated track or friendly aircraft.
BLANK	A suppression of enemy air defenses (SEAD) aircraft does not detect any emitters of interest.
BLIND	No visual contact with friendly aircraft/ground position; opposite of VISUAL.
BLOW THROUGH	Directive/informative call that indicates aircraft will continue straight ahead at the merge and not turn with target/targets.
BOGEY	A radar or visual air contact whose identity is unknown.
BOGEY DOPE	Request for target information as briefed/available.
BOX	Groups/contacts/formations in a square or offset square.

BRAA	Tactical control format providing target bearing, range, altitude, and aspect, relative to a friendly aircraft.
BRACKET	Indicates geometry where friendly aircraft will maneuver to a position on opposing sides, either laterally or vertically from the target.
BREAK (Direction)	Directive to perform an immediate maximum performance turn in the direction indicated; assumes a defensive situation.
BREAKAWAY	Tanker or receiver directive call indicating immediate vertical and nose/tail separation between tanker and receiver is required.
BREVITY	Radio frequency is becoming saturated, degraded, or jammed and briefer transmissions must follow.
BROADCAST	Request/directive to switch to broadcast control.
BROKE LOCK	Loss of radar/infrared (IR) lock-on (advisory).
BRUISER	Friendly air-launched antishipmissile (ASM) (for example, HARPOON, EXOCET, PENGUIN).
BUDDY LOCK	Locked to a known friendly aircraft; normally a response to a SPIKE or BUDDY SPIKE call and accompanied with position/heading/altitude.
BUDDY SPIKE	Friendly aircraft air-to-air indication on radar warning receiver (RWR); to be followed by position/heading/altitude.
BUGOUT (Direction)	Separation from that particular engagement/attack/operation; no intent to re-engage/return.
BULLDOG	Friendly surface/submarine-launched ASM (for example, HARPOON, EXOCET, OTOMAT).
BULLSEYE	An established point from which the position of an object can be referenced; made by cardinal/range or digital format.
BUMP/BUMP-UP	A fly-up to acquire line of sight (LOS) to the target or laser designation.
BURN	GLINT used to provide illumination.
BUSTER	Directive call to fly at maximum continuous speed (military power).
BUZZER	Electronic communications jamming.

OPERATIONAL TERMS AND GRAPHICS

CANDYGRAM	Informative call to aircraft that EW targeting information is available on a briefed secure net.
CAP/CAPPING (Location)	<ol style="list-style-type: none">1. Directive call to establish an orbit at a specified location.2. An orbit at a specified location.
CAPTURED	Aircrew has identified and is able to track a specified air-to-ground (A/G) target with an onboard sensor.
CEASE ENGAGEMENT	In air defense, break the engagement on the target specified. Missiles in flight will continue to intercept.
CEASE FIRE	Do not open fire or discontinue firing; complete intercept if weapons are in flight; continue to track.
CHAMPAGNE	An attack of three distinct groups with two in front and one behind.
CHATTERMARK	Begin using briefed radio procedures to counter communications jamming.
CHEAPSHOT	<ol style="list-style-type: none">1. (USAF) Active missile supported to high pulse repetition frequency (HPRF), but not medium pulse repetition frequency (MPRF).2. (Naval) Active missile not supported to active range.
CHECK (Left/Right)	Turn () degrees left or right and maintain new heading.
CHERUBS	Height of a friendly aircraft in hundreds of feet.
CHICKS	Friendly aircraft.
CLEAN	<ol style="list-style-type: none">1. No radar contacts on aircraft of interest.2. No visible battle damage3. Aircraft not carrying external stores.
CLEARED	Requested action is authorized (no engaged/support roles are assumed).
CLEARED HOT	Ordnance release is authorized.
CLOAK	Directive/informative call to switch from normal external lighting to covert night vision device (NVD) only compatible lighting.
CLOSING	Decreasing in range.

COLD	<ol style="list-style-type: none">1. Attack geometry will result in a pass or rollout behind the target.2. On a leg of the combat air patrol (CAP) pointed away from the anticipated threats.3. Group(s) heading away from friendly aircraft.
COLOR (System/Position)	Request for information on a (system) at stated location; usually a request for ambiguity resolution. May be used with improved data modem (IDM) data message--COLOR, DATA.
COME OFF (Left/Right/)	Directive to maneuver as indicated to either regain mutual support or to deconflict flight paths for an exchange of engaged and supporting roles; Low/Dry) implies both VISUAL and TALLY.
COMMIT(TED)	Fighter intent to engage/intercept; controller continues to provide information.
CONFETTI	Chaff lane or corridor.
CONS/CONNING	THREAT/BOGEY aircraft leaving contrails.
CONTACT	<ol style="list-style-type: none">1. Sensor contact at the stated position.2. Acknowledges sighting of a specified reference point.
CONTINUE	Continue present maneuver; does not imply clearance to engage or expend ordnance.
CONTINUE DRY	Ordnance release not authorized.
COVER(ING)*	<ol style="list-style-type: none">1. Directive/informative call to take S/A action or establish an air-to-air (A/A) posture that will allow engagement of a specified target or threat.
CRANK (Direction)	F-pole maneuver; implies illuminating target at radar gimbal limits.
CUTOFF	Request for, or directive to, intercept using cutoff geometry.
CYCLOPS	Any unmanned aerial vehicle (UAV).
DASH (#)	Aircraft position within a flight. Use if specific call sign is unknown.
DATA	Standby for IDM data message concerning (object) at stated location.
DEADEYE	Informative call by an airborne laser designator indicating the laser/IR system is inoperative.
DECLARE	Inquiry as to the identification of a specified track(s), target(s), or correlated group.

OPERATIONAL TERMS AND GRAPHICS

DEFENSIVE (SPIKE/Missile/ SAM/MUD/AAA)	Aircraft is in a defensive position and maneuvering with reference to the stated condition.
DE-LOUSE	Directive to detect and identify unknown aircraft trailing friendly aircraft.
DEPLOY	Directive to maneuver to briefed positioning.
DIVERT	Proceed to alternate mission or base.
DOLLY	Link-4A/TADIL C.
DRAG(ING) (Direction)	1. (USAF) Target stabilized at 0 to 60 degrees aspect. 2. (Naval) Target stabilized at 120 to 180 degrees aspect.
DROP(ING)	1. Directive/informative call to stop monitoring a specified emitter/target and resume search responsibilities. 2. Remove the emitter/target from tactical picture/track stores.
DUCK*	Tactical air-launched decoy (TALD).
ECHELON	Groups/contacts/formation with wingman displaced approximately 45 degrees behind leader's 3/9 line.
ECHO	Positive SEESAW/electronic warfare weapons system (EWWS)/ System M/Mode X reply.
ENGAGED	Maneuvering with the intent to kill; this implies visual/radar acquisition of target.
ESTIMATE	Provides estimate of the size, range, height, or other parameter of a specified contact; implies degradation.
EXTEND (Direction)	Short-term maneuver to gain energy, distance, or separation; normally with the intent of re-engaging.
EYEBALL()	1. Fighter with primary visual identification responsibility. 2. Electro-optical (EO)/IR/NVD acquisition of an aircraft. Normally followed by () number of aircraft observed.
FADED	Radar contact is lost. (Termination of track plotting is not warranted.)
FAST*	Target speed is estimated to be 600 knots ground speed/Mach 1 or greater.
FATHER	Tactical air navigation (TACAN) station.

FEET WET/DRY	Flying over water/land.
FENCE (IN/OUT)	Set cockpit switches as appropriate prior to entering/exiting the combat area.
FLANK(ING)	1. (USAF) Target with a stable aspect of 120 to 150 degrees. 2. (Naval) Target with stable aspect of 30 to 60 degrees.
FLASH (System)	Temporarily turn on prebriefed identification, friend or foe (IFF) mode or system.
FLOAT	Directive/informative call to expand the formation laterally within visual limits to maintain a radar contact or prepare for a defensive response.
FOX (Number)	Simulated/actual launch of air-to-air weapons. ONE - semiactive radar-guided missile. TWO - infrared-guided missile. THREE - active radar-guided missile.
FOX MIKE	Very high frequency (VHF)/frequency modulated (FM) radio.
FRIENDLY	A positively identified friendly contact.
FURBALL	A turning fight involving multiple aircraft with known BANDITS and FRIENDLIES mixed.
GADGET	Radar or emitter equipment.
GATE	Directive/informative call to fly as quickly as possible, using after-burner/maximum power.
GIMBAL (Direction)	Radar target is approaching azimuth or elevation limits.
GO ACTIVE	Go to briefed Have Quick net.
GO CLEAR	Use unencrypted voice communications.
GOGGLE/ DEGOGGLE	Directive/informative call to put on/take off NVDs.
GORILLA	Large force of indeterminate numbers and formation.
GO SECURE	Use encrypted voice communications.
GRANDSLAM	All HOSTILE aircraft of a designated track (or against which a mission was tasked) are shot down.

OPERATIONAL TERMS AND GRAPHICS

GREEN (Direction)	Direction determined to be clearest of enemy air-to-air activity.
GREYHOUND	Friendly ground attack cruise missile (for example, Tomahawk Land Attack Missile (TLAM) and Conventional Air-launched Cruise Missile (CALCM)).
GROUP	Radar targets within approximately 3 nautical miles (NMs) of each other.
GUNS	An air-to-air or air-to-surface gunshot.
HARD (Direction)	High-G, energy-sustaining turn.
HEAD/ HEAD ON	1. (USAF) Target with an aspect of 160 to 180 degrees. 2. (Naval) Target with an aspect of 0 to 20 degrees.
HEADS UP	Alert of an activity of interest.
HEAVY*	A group or package known to contain three or more entities.
HIGH*	Between 25,000 and 40,000 feet mean sea level (MSL).
HIT(S)	1. Air-to-air (A/A) Momentary radar returns search. (Indicates approximate altitude information from fighter.) 2. Air-to-ground (A/G) Weapons impact within lethal distance.
HOLD DOWN	Directive to key transmitter for direction-finding (DF) steer.
HOLDING HANDS	Aircraft in visual formation.
HOLD FIRE	An emergency fire control order used to stop firing on a designated target, to include destruction of any missiles in flight.
HOME PLATE	Home airfield or carrier.
HOOK (Left/Right)	Directive to perform an in-place 180-degree turn.
HOSTILE*	A contact identified as enemy upon which clearance to fire is authorized in accordance with theater rules of engagement.
HOT	1. Attack geometry will result in rollout in front of the target. 2. On a leg of the CAP pointing toward the anticipated threats. 3. Group heading towards friendly aircraft; opposite of COLD. 4. Ordnance employment intended or completed.
HOTDOG	Informative/directive call that an aircraft is approaching or at a specified standoff distance from the sovereign airspace of a nation (as defined by national boundaries

	or territorial sea and airspace). (COLOR may indicate additional standoff distance.) Follow briefed procedures.
HOTEL FOX	High frequency (HF) radio.
HUSKY	(Naval) Air Intercept Missile (AIM)-120 supported to HPRF active range; same as USAF CHEAPSHOT.
ID	1. Directive to identify the target. 2. Identification accomplished, followed by type.
IN (Direction)	Informative call indicating a turn to a hot aspect relative to a THREAT/TARGET.
INDIA	Mode IV.
INTERROGATE	Interrogate the designated contact of the IFF mode indicated.
JACKAL	Surveillance network participating group (NPG) of Link 16/TADIL J.
JOKER*	Fuel state above BINGO at which separation/bugout/event termination should begin.
JUDY	Aircrew has radar/visual contact on the correct target, has taken control of the intercept, and only requires situation awareness information. Controller will minimize radio transmissions.
KILL	1. Clearance to fire. 2. In training, a fighter call to indicate kill criteria have been fulfilled.
KNOCK IT OFF	Directive to cease air combat maneuvers/attacks/activities.
LADDER	Three or more groups/contacts in range.
LASER ON	Directive to start laser designation.
LEAD-TRAIL	Tactical formation of two contacts within a group separated in range or following one another.
LEAKER(S)	Airborne threat has passed through a defensive layer. Call should include amplifying information.
LINE ABREAST	Two contacts within a group side by side.
LIGHTS ON/OFF	Directive to turn on/off exterior lights.

OPERATIONAL TERMS AND GRAPHICS

LOCKED (BRAA/Direction)	Final radar lock-on; sort is not assumed.
LOST CONTACT	Radar contact lost. (DROP track is recommended.)
LOST LOCK	Loss of radar/IR lock-on (advisory).
LOW*	Target altitude below 10,000 feet above ground level (AGL).
MAGNUM	Launch of friendly antiradiation missile.
MAPPING	Multifunction radar in an A/G mode.
MARKING	Friendly aircraft leaving contrails.
MARSHAL(ING)	Establish(ed) at a specific point.
MEDIUM*	Target altitude between 10,000 feet AGL and 25,000 feet MSL.
MERGE(D)	1. Information that friendlies and targets have arrived in the same visual arena. 2. Call indicating radar returns have come together.
MICKEY	Have Quick Time-of-Day (TOD) signal.
MIDNIGHT	Informative call advising that C ² functions are no longer available; opposite of SUNRISE.
MONITOR	Maintain radar awareness on or assume responsibility for specified group.
MOTHER	Parent ship.
MUD (Type/Direction)	Indicates RWR ground threat displayed followed by clock position and type.
MUSIC	Electronic radar jamming. (On air interdiction (AI) radar, electronic deceptive jamming.)
NAILS	Radar warning receiver indication of AI radar in search. Add clock position/azimuth, if known.
NAKED	No RWR indications.
NEW PICTURE	Used by controller or aircrew when tactical picture has changed. Supersedes all previous calls and re-establishes picture for all players.

NO FACTOR	Not a threat.
NO JOY	Aircrew does not have visual contact with the TARGET/BANDIT/landmark; opposite of TALLY.
NOTCH (Direction)	All-aspect missile defensive maneuver to place threat radar/missile on the beam.
OFF (Direction)	Informative call indicating attack is terminated and maneuvering to the indicated direction.
OFFSET (Direction)	Informative call indicating maneuver in a specified direction with reference to the target.
ON STATION	Informative call unit/aircraft has reached assigned station.
OPENING	Increasing in range.
OUT (Direction)	Informative call indicating a turn to a cold aspect relative to the threat; opposite of IN.
OUTLAW	Informative call that a bogey has meet point of origin criteria.
PACKAGE	Geographically isolated collection of groups/contacts/formations.
PADLOCKED	Informative call indicating aircrew cannot take eyes off an aircraft or a surface position without risk of losing TALLY/VISUAL.
PAINT(S)	Interrogated group/radar contact that is responding with any of the specified IFF modes and correct codes established for the ID criteria.
PARROT	IFF transponder.
PICTURE	Provide tactical situation status pertinent to mission.
PIGEONS (Location)	Magnetic bearing and range to HOMEPLATE (or specified destination).
PINCE/PINCER	Threat maneuvering for a bracket attack.
PITBULL	1. Informative call AIM-120 is at MPRF active range. 2. AIM-54 at active range.
PLAYMATE	Cooperating aircraft.

OPERATIONAL TERMS AND GRAPHICS

PLAYTIME	Amount of time aircraft can remain on station.
POGO	Switch to communication channel number preceding POGO. If unable to establish communications, switch to channel number following POGO. If no channel number follows POGO, return to this channel.
POP	Starting climb for air-to-surface attack.
POPEYE	Flying in clouds or area of reduced visibility.
POPUP	Informative call of a contact that has suddenly appeared inside of meld/CCR/briefed range.
POSIT	Request for position; response in terms of a geographic landmark, or off a common reference point.
POST ATTACK (Direction)	Directive transmission to indicate desired direction after completion of intercept/engagement.
POST HOLE	Rapid descending spiral.
PRESS	Directive to continue the attack; mutual support will be maintained. Supportive role will be assumed.
PRINT (Type)	Unambiguous noncooperative target recognition (NCTR) reply.
PUMP	A briefed maneuver to low aspect to stop closure on the threat or geographical boundary with the intent to re-engage.
PURE	Informative call indicating pure pursuit is being used or directive to go pure pursuit.
PUSH (Channel)	Go to designated frequency. No acknowledgment required.
PUSHING	Departing designated point.
PUSHING (Group Description)	Informative call that said group(s) have turned cold and will continue to be monitored.
RANGE*	Two or more groups separated primarily in distance along the same bearing.
RAYGUN (Position/Heading/ Altitude)	Indicates a radar lock-on to unknown aircraft; a request for a BUDDY SPIKE reply from friendly aircraft meeting these parameters (to prevent fratricide).

REFERENCE (Direction)	Directive to assume stated heading.
REPORTED (Type)	Identification of an object or a contact by an intelligence system.
RESET	Proceed to a prebriefed position or area of operation.
RESUME	Resume last formation/ station/mission ordered.
RETROGRADE	Directive to withdraw from present position or area of operation in response to a threat.
RIDER	A BOGEY that is conforming with safe passage routing/airspeed/altitude procedures.
RIFLE	Air-to-ground missile (AGM)-65 Maverick launch.
RIPPLE	Two or more munitions released or fired in close succession.
ROLEX (+/- Time)	Time-line adjustment in minutes from planned mission execution time. (Plus means later; minus means earlier).
ROPE	Illumination of an aircraft with an IR pointer.
SADDLED	Informative call from wingman/element indicating the return to briefed formation position.
SAM (Direction)	Visual acquisition of a SAM or SAM launch; should include position.
SANDWICHED	A situation where an aircraft/element is positioned between opposing aircraft/elements.
SAUNTER	Fly at best endurance.
SCRAM (Direction)	Emergency directive to egress for defensive or survival reasons.
SCRAMBLE	Takeoff as quickly as possible.
SCUD	Any threat tactical/theater ballistic missile (TBM).
SEPARATE	Leave a specific engagement; may or may not reenter.

OPERATIONAL TERMS AND GRAPHICS

SHACKLE	One WEAVE, a single crossing of flight paths; maneuver to adjust/regain formation parameters.
SHADOW	Follow indicated target.
SHIFT	Directive to shift laser illumination.
SHOOTER	Aircraft/unit designated to employ ordnance.
SHOTGUN	Prebriefed weapons state at which SEPARATION/BUGOUT should begin.
SKATE	Informative call/directive to execute launch and leave tactics.
SKIP IT	Veto of fighter COMMIT, usually followed with further directions.
SKOSH	Aircraft is out of or unable to employ active radar missiles.
SKUNK	A radar or visual maritime surface contact whose identity is unknown.
SLAPSHOT (Type/Bearing)	Directive for an aircraft to employ a range-unknown high-speed antiradiation missile (HARM) against a specified threat at the specified bearing.
SLIDE	Directive call to high value airborne asset (HVAA) to continue present mission while extending range from target in response to perceived threat.
SLOW*	Target with a ground speed of 300 knots or less.
SMASH	Directive to turn on/off anticollision lights.
SMOKE	Smoke marker used to mark a position.
SNAKE	Directive to oscillate an IR pointer about a target.
SNAP (Direction)	An immediate vector to the group described.
SNIPER	Directive for an aircraft to employ a range-known HARM against a specified threat at the specified location.
SNOOZE	Directive/informative call indicating initiation of EMCON procedures.
SORT	Directive to assign responsibility within a group; criteria can be met visually, electronically (radar), or both.
SORTED	Sort responsibility has been met.

SOUR	<ol style="list-style-type: none">1. Equipment indicated is operating inefficiently.2. Invalid response to an administrative IFF check. (Opposite of SWEET.)
SPADES	An integrated group/radar contact which lacks the ATO (or equivalent) IFF modes and codes required for the ID criteria.
SPARKLE	Target marking by IR pointer; target marking by gunship or forward air controller (airborne) (FAC-A) using incendiary rounds.
SPIKE	RWR indication of an AI threat in track, launch, or unknown mode; include bearing, clock position, and threat type, if known.
SPIN	Directive/informative call to execute a prebriefed timing/spacing maneuver.
SPITTER (Direction)	An aircraft that has departed from the engagement or is departing the engaged fighters' targeting responsibility.
SPLASH	<ol style="list-style-type: none">1. (A/A) Target destroyed.2. (A/G) Weapons impact.
SPLIT	An informative call that a flight member is leaving information to engage a threat; visual may not be maintained.
SPOOFING	Informative call that voice deception is being employed.
SPOT*	Acquisition of laser designation.
SQUAWK ()	Operate IFF as indicated or IFF is operating as indicated.
SQUAWKING	An informative call denoting a bogey is responding with an IFF mode (#).
STACK	Two or more groups/contacts/ formations with a high/low altitude separation in relation to each other.
STATUS	Request for tactical situation.
STEADY	Directive to stop oscillation of IR pointer.
STEER	Set magnetic heading indicated.
STERN	Request for, or directive to, intercept using stern geometry.
STINGER	Within a group, a formation of three or more aircraft with a single aircraft in trail.

OPERATIONAL TERMS AND GRAPHICS

STOP	Stop IR illumination of a target.
STRANGER	Unidentified traffic that is not associated with the action in progress.
STRANGLE ()	Turn off equipment indicated.
STRIP	Individual fighter/section is leaving the formation to pursue separate attacks.
STRIPPED	Informative call from wingman/element indicating out of briefed formation/position.
STROBE	Radar indications of noise jamming.
SUNSHINE	Directive or informative call indicating illumination of target is being conducted with artificial illumination.
SUNRISE	Informative call that C ² functions are available (opposite of MIDNIGHT).
SWEET	1. Equipment indicated is operating efficiently. 2. Valid response to an administrative IFF check. (Opposite of sour.)
SWITCH(ED)	Indicates an attacker is changing from one aircraft to another.
TACTICAL	Request/directive to switch to tactical control.
TAG (system w/position)	Known identification of a specific (system) at the stated location; may be used with IDM data message, (for example, TAG DATA).
TALLY	Sighting of a TARGET, BANDIT, BOGEY, or enemy position; opposite of NO JOY.
TARGET ()	Directive to assign group responsibility to aircraft in a flight.
TARGETED ()	Group responsibility has been met.
TEN SECONDS	Directive to terminal controller to standby for LASER ON call in approximately 10 seconds.
TERMINATE	1. Stop laser illumination of a target. 2. Cease local engagement without affecting the overall exercise.
THREAT (Direction)	Untargeted HOSTILE/BANDIT/BOGEY within prebriefed range/aspect of a friendly.

THROTTLES	Reduction in power to decrease IR signature.
TIED	Positive radar contact with element/aircraft.
TIGER	Enough fuel and ordnance to accept a COMMIT.
TIMBER	Air control NPG of Link 16/TADIL J.
TRACKING	1. Stabilized gun solution. 2. Continuous illumination of a target. 3. Contact heading.
TRAILER*	The last aircraft within a group(s).
TRASHED	Informative call that missile has been defeated.
TRESPASS (Position)	The addressed flight is entering a S/A threat ring of a specific system at the stated location.
TUMBLEWEED	Indicates limited situational awareness; NO JOY, BLIND; a request for information.
UNABLE	Cannot comply as requested/directed.
UNIFORM	Ultrahigh frequency (UHF) radio.
VAMPIRE	Hostile antiship missile (ASM).
VERY HIGH*	Above 40,000 feet MSL.
VIC	Three groups, contacts, or formations with the single closest in range and two contacts, azimuth split, in trail.
VICTOR	VHF/amplitude modulation (AM) radio.
VISUAL	Sighting of a friendly aircraft/ground position; opposite of BLIND.
WALL	Three or more groups or contacts primarily split in azimuth.
WARNING (color)	Hostile attack is— RED imminent or in progress. YELLOW probable. WHITE improbable (all clear).

OPERATIONAL TERMS AND GRAPHICS

WEAPONS ()	Fire only— FREE at targets not identified as friendly in accordance with current rules of engagement (ROE). TIGHT at targets positively identified as hostile in accordance with current ROE. HOLD* (USA, USMC) in self-defense or in response to a formal order. SAFE (USN) NOTE: USN and NATO use WEAPONS SAFE to avoid confusion with the phrase HOLD FIRE.
WEEDS	Indicates that fixed-wing aircraft are operating below 2,000 feet AGL.
WHAT LUCK	Request for results of missions or tasks.
WHAT STATE	Report amount of fuel and missiles remaining. Ammunition and oxygen are reported only when specifically requested or critical. () Active = number of active radar missiles remaining. () Radar = number of semiactive radar missiles remaining. () Heat = number of IR missiles remaining. () Fuel = pounds of fuel or time remaining.
WINCHESTER	No ordnance remaining.
WORDS	Directive or interrogative regarding further information or directives pertinent to mission.
WORKING	1. A SEAD aircraft is gathering EOB on a designated emitter; generally followed by signal type, (SAM/AAA/group) bearing, and range, if able. 2. Aircraft executing electronic identification (EID) on a specific aircraft/group to obtain identification necessary for beyond visual range (BVR) employment.
YARDSTICK	Directive to use A/A TACAN for ranging.

References

STANDARDIZATION AGREEMENTS

STANAG 1059		<i>National Distinguishing Letters for Use by NATO Armed Forces.</i>
STANAG 2019	APP-6	<i>Military Symbols for Land Based Systems.</i>
STANAG 2022		<i>Intelligence Reports.</i>
STANAG 2961		<i>Classes of Supply of NATO Land Forces.</i>
STANAG 3680	AAP-6	<i>NATO Glossary of Terms and Definitions.</i>
STANAG 4420		<i>Display Symbolology and Colors for NATO Maritime Units.</i>

MILITARY STANDARDS

MILSTD 2525A		<i>Common Warfighting Symbolology.</i> 15 December 1996.
--------------	--	--

JOINT AND MULTISERVICE PUBLICATIONS

JP 0-2		<i>Unified Action Armed Forces.</i> 24 February 1995.
JP 1-02		<i>Department of Defense Dictionary of Military and Associated Terms.</i> 23 March 1994.
JP 3-0		<i>Doctrine for Joint Operations.</i> 1 February 1995.
JP 3-01.5		<i>Doctrine for Joint Theater Missile Defense.</i> 22 February 1996.
JP 3-02		<i>Joint Doctrine for Amphibious Operations.</i> 8 October 1992.
JP 3-02.1		<i>Joint Doctrine for Landing Force Operations.</i> 1 November 1989.
JP 3-05		<i>Doctrine for Joint Special Operations.</i> 28 October 1992.
JP 3-07		<i>Joint Doctrine for Military Operations Other Than War.</i> 16 June 1995.
JP 3-12		<i>Doctrine for Joint Nuclear Operations.</i> 18 December 1995.
JP 3-12.1		<i>Doctrine for Joint Theater Nuclear Operations.</i> 9 February 1996.
JP 3-12.2 (SRD)		<i>Nuclear Weapons Employment and Effects Data.</i> (U) 20 December 1995.
JP 3-12.3		<i>Nuclear Weapons Employment and Effects Data.</i> 14 February 1996.
JP 3-13		<i>Joint Doctrine for Information Warfare,</i> under development.
JP 3-18.1		<i>Joint Doctrine for Airborne and Air Assault Operations,</i> under development.

OPERATIONAL TERMS AND GRAPHICS

- JP 3-53 *Doctrine for Joint Psychological Operations.* 30 July 1993.
- JP 3-56 *Command and Control Doctrine for Joint Operations.* 3 May 1995.
- JP 3-58 *Joint Doctrine for Military Deception.* 31 May 1996.
- JP 5-0 *Doctrine for Planning Joint Operations.* 13 April 1995.
- FM 3-3 *Chemical and Biological Contamination Avoidance.* FMFM 11-17. 16 November 1992.
- FM 3-3-1 *Nuclear Contamination Avoidance.* FMFM 11-18. 9 September 1994.
- FM 3-4 *NBC Protection.* FMFM 11-19. 29 May 1992.
- FM 3-5 *NBC Decontamination.* FMFM 11-10. 17 November 1993.
- FM 3-6 *Field Behavior of NBC Agents.* AFM 105-7; FMFM 7-11. 3 November 1986.
- FM 3-9 *Potential Military Chemical/Biological Agents and Compounds.* NAVFAC P-467; AFR 355-7. 12 December 1990.
- FM 3-11 *Flame, Riot Control Agents, and Herbicide Operations.* MCRP 3-3.7.2. 19 August 1996.
- FM 3-19 *NBC Reconnaissance.* FMFM 11-20. 19 November 1993.
- FM 3-100 *NBC Defense, Chemical Warfare, Smoke, and Flame Operations.* FMFM 11-2. 23 May 1991.
- FM 8-9 *NATO Handbook on the Medical Aspects of NBC Defensive Operations.* NAVMED P-5059; AFP 161-3. 31 August 1973.
- FM 20-12 *Amphibious Operations.* LFM 03; NWP 22-6; AFR 75.6. 11 June 1987.
- FM 33-1 *Psychological Operations.* FMFM 3-53. 18 February 1993.
- FM 90-13 *River Crossing Operations.* FMFM 7-26. 30 September 1992.
- FM 90-38 *Multiservice Air-Air, Air-Surface, Surface-Air Brevity Codes.* MCRP 3-25B; NWP 6-02.1; AFJPAM 10-228. 25 April 1997.
- FM 100-19 *Domestic Support Operations.* FMFM 7-10. 1 July 1993.

ARMY PUBLICATIONS

- AR 25-1 *The Army Information Resources Management Program.* 18 November 1988.
- AR 310-25 *Dictionary of United States Army Terms.* 15 October 1986.
- AR 310-50 *Authorized Abbreviations, Brevity Codes, and Acronyms.* 15 November 1985.

FM 1-100 *Doctrinal Principles for Army Aviation in Combat Operations.*
28 February 1989.

FM 1-103 *Airspace Management and Army Air Traffic in a Combat Zone.* 30 December
1981.

FM 1-111 *Aviation Brigades.* 27 August 1990.

FM 1-112 *Tactics, Techniques, and Procedures for the Attack Helicopter Battalion.*
21 February 1991.

FM 1-113 *Assault Helicopter Battalion.* 28 October 1985.

FM 1-114 *Tactics, Techniques, and Procedures for the Regimental Aviation Squadron.*
20 February 1991.

FM 1-116 *Tactics, Techniques, and Procedures for the Air Cavalry/Reconnaissance Troop.*
20 February 1991.

FM 3-7 *NBC Field Handbook.* 29 September 1994.

FM 3-50 *Smoke Operations.* 4 December 1990.

FM 5-34 *Engineer Field Data.* 14 September 1987.

FM 5-36 *Route Reconnaissance and Classification.* 10 May 1985.

FM 5-71-100 *Division Engineer Combat Operations.* 22 April 1993.

FM 5-100 *Engineer Combat Operations.* 22 November 1988.

FM 5-101 *Mobility.* 23 January 1985.

FM 5-102 *Countermobility.* 14 March 1985.

FM 5-103 *Survivability.* 10 June 1985.

FM 5-114 *Engineer Operations Short of War.* 13 July 1992.

FM 5-250 *Explosives and Demolitions.* 15 June 1992.

FM 6-series Field Artillery.

FM 6-20 series Fire Support.

FM 6-20 *Fire Support in the AirLand Battle.* 17 May 1988.

FM 6-20-10 *Tactics, Techniques, and Procedures for the Targeting Process.* 29 March 1990.

FM 6-20-20 *Tactics, Techniques, and Procedures for Fire Support at Battalion Task Force
and Below.* 27 December 1991.

FM 6-20-30 *Tactics, Techniques, and Procedures for Fire Support for Corps and Division
Operations.* 18 October 1989.

OPERATIONAL TERMS AND GRAPHICS

- FM 6-30 *Tactics, Techniques, and Procedures for Observed Fire.* 16 July 1991.
- FM 6-50 *Tactics, Techniques, and Procedures for the Field Artillery Cannon Battery.* 20 November 1990.
- FM 7-7 *The Mechanized Infantry Platoon and Squad (APC).* 15 March 1985.
- FM 7-8 *Infantry Rifle Platoon and Squad.* 22 April 1992.
- FM 7-10 *The Infantry Rifle Company.* 14 December 1990.
- FM 7-20 *The Infantry Battalion.* 6 April 1992.
- FM 7-30 *Infantry, Airborne, and Air Assault Brigade Operations.* 24 April 1981.
- FM 7-90 *Tactical Employment of Mortars.* 9 October 1992.
- FM 7-91 *Tactical Employment of Antiarmor Platoons, Companies, and Battalions.* 30 September 1987.
- FM 7-92 *The Infantry Reconnaissance Platoon and Squad.* 23 December 1992.
- FM 8-series Medical.
- FM 8-10 *Health Service Support in a Theater of Operations.* 1 March 1991.
- FM 8-10-1 *The Medical Company Tactics, Techniques, and Procedures.* 29 December 1994.
- FM 8-10-3 *Division Medical Operations Center, Tactics, Techniques, and Procedures, final draft,* November 1995.
- FM 8-10-4 *Medical Platoon Leaders' Handbook, Tactics, Techniques, and Procedures.* 16 November 1990.
- FM 8-10-5 *Brigade and Division Surgeons' Handbook for Tactics, Techniques, and Procedures.* 10 June 1991.
- FM 8-10-6 *Medical Evacuation in a Theater of Operations, Tactics, Techniques, and Procedures.* 31 October 1991.
- FM 8-10-7 *Health Service Support in a Nuclear, Biological, and Chemical Environment.* 22 April 1993.
- FM 8-10-8 *Medical Intelligence in a Theater of Operations.* 7 July 1989.
- FM 8-10-9 *Combat Health Logistics in a Theater of Operations, Tactics, Techniques, and Procedures.* 3 October 1995.
- FM 8-10-14 *Employment of the Combat Support Hospital, Tactics, Techniques, and Procedures.* 29 December 1994.

- FM 8-10-15 *Employment of the Field and General Hospitals, Tactics, Techniques, and Procedures*, final draft, December 1995.
- FM 8-10-24 *Area Support Medical Battalions Tactics, Techniques, and Procedures*. 13 October 1993.
- FM 8-10-25 *Employment of Forward Surgical Teams*, draft.
- FM 8-33 *Control of Communicable Diseases in Man*. 31 May 1991.
- FM 8-42 *Medical Operations in Low Intensity Conflict*. 4 December 1990.
- FM 8-51 *Combat Stress Control in a Theater of Operation Tactics, Techniques, and Procedures*. 29 September 1994.
- FM 8-55 *Planning for Health Service Support*. 9 September 1994.
- FM 9-6 *Munitions Support in Theaters of Operations*. 1 September 1989.
- FM 10-1 *Quartermaster Principles*. 11 August 1994.
- FM 10-63 *Handling of Deceased Personnel in Theaters of Operations*. 28 February 1986.
- FM 10-63-1 *Graves Registration Handbook*. 17 July 1986.
- FM 10-67 *Petroleum Supply in Theaters of Operation*. 16 February 1983.
- FM 12-6 *Personnel Doctrine*. 9 September 1994.
- FM 16-1 *Religious Support*. 26 May 1995.
- FM 17-12 *Tank Gunnery*.
- FM 17-15 *Tank Platoon*. 7 October 1987.
- FM 17-95 *Cavalry Operations*. 19 September 1991.
- FM 17-98 *Scout Platoon*. 9 September 1994.
- FM 19-1 *Military Police Support for the AirLand Battle*. 23 May 1988.
- FM 19-4 *Military Police Battlefield Circulation Control, Area Security, and Enemy Prisoner of War Operations*. 7 May 1993.
- FM 19-10 *Military Police Law and Order Operations*. 30 September 1987.
- FM 19-15 *Civil Disturbances*. 25 November 1985.
- FM 19-40 *Enemy Prisoners of War, Civilian Internees, and Detained Persons*. 27 February 1976.
- FM 20-32 *Mine/Countermine Operations*. 30 September 1992.

OPERATIONAL TERMS AND GRAPHICS

FM 21-10	<i>Field Hygiene and Sanitation.</i> 22 November 1988.
FM 21-18	<i>Foot Marches.</i> 1 June 1990.
FM 21-26	<i>Map Reading and Land Navigation.</i> 7 May 1993.
FM 22-51	<i>Leaders' Manual for Combat Stress Control.</i> 29 September 1994.
FM 22-100	<i>Military Leadership.</i> 31 July 1990.
FM 22-102	<i>Soldier Team Development.</i> 2 March 1987.
FM 22-103	<i>Leadership and Command at Senior Levels.</i> 21 June 1987.
FM 23-1	<i>Bradley Fighting Vehicle Gunnery.</i> 1 March 1991.
FM 24-1	<i>Signal Support and the Information Mission Area.</i> May 1993.
FM 25-100	<i>Training the Force.</i> 15 November 1988.
FM 25-101	<i>Battle Focused Training.</i> 30 September 1990.
FM 27-10	<i>The Law of Land Warfare.</i> 18 July 1956.
FM 31-12	<i>Army Forces in Amphibious Operations.</i> 28 March 1961.
FM 31-20	<i>Doctrine for Special Forces Operations.</i> 20 April 1990.
FM 31-20-3	<i>Foreign Internal Defense Tactics, Techniques, and Procedures for Special Forces.</i> 20 September 1994.
FM 34-1	<i>Intelligence and Electronic Warfare Operations.</i> 27 September 1994.
FM 34-2	<i>Collection Management and Synchronization Planning.</i> 8 March 1994.
FM 34-3	<i>Intelligence Analysis.</i> 15 March 1990.
FM 34-8	<i>Combat Commander's Handbook on Intelligence.</i> 28 September 1992.
FM 34-10	<i>Division Intelligence and Electronic Warfare Operations.</i> 25 November 1986.
FM 34-10-1	<i>TTP for the Remotely Monitored Battlefield Sensor System (REMBASS).</i> 18 June 1991.
FM 34-10-2	<i>Intelligence and Electronic Warfare Equipment Handbook.</i> 13 July 1993.
FM 34-40	<i>Electronic Warfare Operations.</i> 9 October 1987.

- FM 34-52 *Intelligence Interrogation.* 28 September 1992.
- FM 34-130 *Intelligence Preparation of the Battlefield.* 8 July 1994.
- FM 41-10 *Civil Affairs Operations.* 11 January 1993.
- FM 44-63 *FAAD/SHORAD Battalion Operations, Heavy Divisions.* 31 March 1992.
- FM 44-100 *US Army Air Defense Operations.* 15 June 1995.
- FM 55-2 *Division Transportation Operations.* 31 January 1985.
- FM 55-9 *Unit Air Movement Planning.* 5 April 1993.
- FM 55-10 *Movement Control in a Theater of Operations.* 8 December 1992.
- FM 55-12 *Movement of Units in Air Force Aircraft.* 12 March 1993.
- FM 55-30 *Army Motor Transport Units and Operations.* 14 March 1980.
- FM 55-450-3 *Multiservice Helicopter External Air Transport Basic Operations and Equipment.*
11 February 1991.
- FM 55-450-4 *Multiservice Helicopter External Air Transport Single-Point Load Rigging*
Procedures. 11 February 1991.
- FM 55-450-5 *Multiservice Helicopter External Air Transport Dual-Point Load Rigging*
Procedures. 11 February 1991.
- FM 63-2 *Division Support Command, Armored, Infantry, and Mechanized Infantry*
Divisions. 20 May 1991.
- FM 63-2-1 *Division Support Command Light Infantry, Airborne, and Air Assault Divisions.*
16 November 1992.
- FM 63-6 *Combat Service Support in Low-Intensity Conflict.* 21 January 1992.
- FM 63-20 *Forward Support Battalion.* 26 February 1990.
- FM 63-21 *Main Support Battalion.* 7 August 1990.
- FM 71-100 *Division Operations.* 28 August 1996.
- FM 71-100-1 *Armor and Mechanized Division Operations Tactics, Techniques, and*
Procedures, final draft, May 1993.
- FM 71-100-2 *Infantry Division Operations, Tactics, Techniques, and Procedures.*
31 August 1993.

OPERATIONAL TERMS AND GRAPHICS

- FM 71-100-3 *Air Assault Division Operations, Tactics, Techniques, and Procedures.* 29 October 1996.
- FM 71-123 *Tactics and Techniques for Combined Arms Heavy Forces: Armored Brigade, Battalion/Task Force, and Company/Team.* 30 September 1992.
- FM 90-4 *Air Assault Operations.* 16 March 1987.
- FM 90-7 *Combined Arms Obstacle Integration.* 29 September 1994.
- FM 90-8 *Counter guerrilla Operations.* 9 August 1986.
- FM 90-10 *Military Operations on Urbanized Terrain.* 15 August 1979.
- FM 90-10-1 *An Infantryman's Guide to Combat in Built-Up Areas.* 12 May 1993.
- FM 90-13 *River Crossing Operations.* 30 September 1992.
- FM 90-13-1 *Combined Arms Breaching Operations.* 28 February 1991.
- FM 90-26 *Airborne Operations.* 18 December 1990.
- FM 90-29 *Noncombatant Evacuation Operations.* 17 October 1994.
- FM 100-5 *Operations.* 14 June 1993.
- FM 100-6 *Information Operations.* 27 August 1996.
- FM 100-7 *Decisive Force: The Army in Theater Operations.* 31 May 1995.
- FM 100-8 *The Army in Multinational Operations,* draft, August 1996.
- FM 100-9 *Reconstitution.* 13 January 1992.
- FM 100-10 *Combat Service Support.* 3 October 1995.
- FM 100-13 *Battlefield Coordination Detachment (BCD).* 12 April 1996.
- FM 100-15 *Corps Operations.* 29 October 1996.
- FM 100-15-1 *Corps Operations Tactics, Techniques, and Procedures,* initial draft, June 1996.
- FM 100-16 *Support Operations: Echelons Above Corps.* 31 May 1995.
- FM 100-17 *Mobilization, Deployment, Redeployment, Demobilization,* final draft, February 1995.
- FM 100-20 *Military Operations in Low Intensity Conflict.* 5 December 1990.
- FM 100-23 *Peace Operations.* 30 December 1994.
- FM 100-25 *Doctrine for Army Special Operations Forces.* 12 December 1991.
- FM 100-30 *Nuclear Operations.* 29 October 1996.

FM 100-40 *Army Tactics*, initial draft, April 1996.

FM 100-103 *Army Airspace Command and Control in a Combat Zone*. 7 October 1987.

FM 100-103-1 *Multiservice Procedures for Integrated Combat Airspace Command Control*.
5 October 1994.

FM 100-103-2 *TAGS Multiservice Procedures for the Theater Air-Ground System*. 31 October
1994.

FM 101-5 *Staff Organization and Operations*. 31 May 1997.

FM 101-10-1/1 *Staff Officers Field Manual Organizational, Technical, and Logistical Data*.
7 October 1987.

FM 101-10-1/2 *Staff Officers Field Manual Organizational, Technical, and Logistical Data*
Planning Factors. 7 October 1987.

FM 701-58 *Planning Logistic Support for Military Operations*. 27 May 1987.

MARINE CORPS PUBLICATIONS

FMFRP 0-14 *Marine Corps Supplement to the DOD Dictionary of Military and Associated*
Terms. 27 January 1994.

NOTE: STANAGS may be obtained from the Navy Publications and Forms Directorate, 5801 Tabor Avenue, Philadelphia, PA 19120-5099. Use DD Form 1425 to requisition documents.

By Order of the Secretary of the Army:

DENNIS J. REIMER
General, United States Army
Chief of Staff

Official:

JOEL B. HUDSON
Administrative Assistant to the
Secretary of the Army

By direction of the Commandant of the Marine Corps:

PAUL K. VAN RIPER
Lieutenant General, U.S. Marine Corps
Commanding General
Marine Corps Combat Development Command

DISTRIBUTION:

Active Army, Army National Guard, and U.S. Army Reserve: To be distributed in accordance with the initial distribution number 110515, requirements for FM 101-5.

